



TRAITÉ
DE LA CHALEUR

CONSIDÉRÉE
DANS SES APPLICATIONS

PAR E. PÉCLET

INSPECTEUR GÉNÉRAL DE L'UNIVERSITÉ, PROFESSEUR DE PHYSIQUE APPLIQUÉE AUX ARTS, A L'ÉCOLE CENTRALE
MEMBRE DE LA SOCIÉTÉ PHILOMATHIQUE, DU CONSEIL DE LA SOCIÉTÉ D'ENCOURAGEMENT, ETC

DEUXIÈME ÉDITION

ENTIÈREMENT REFONDUE

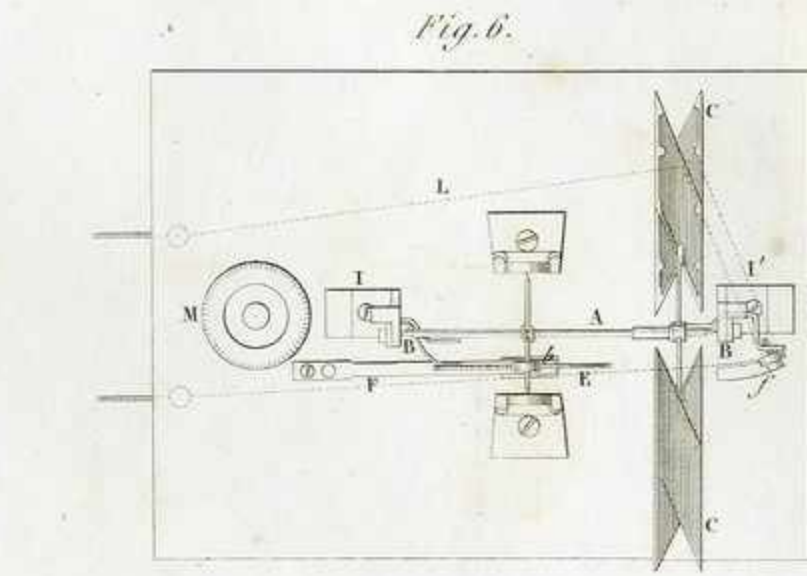
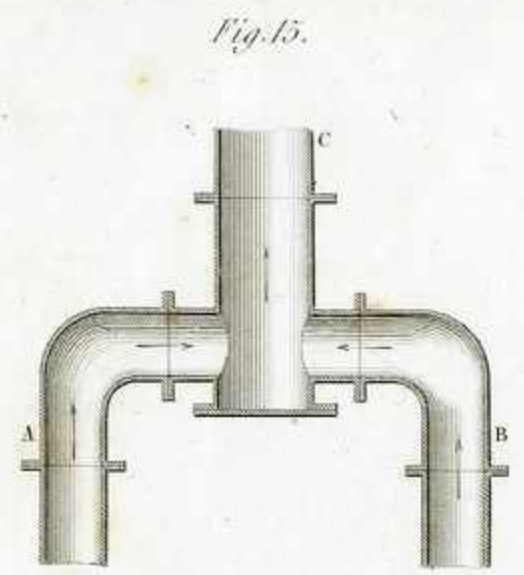
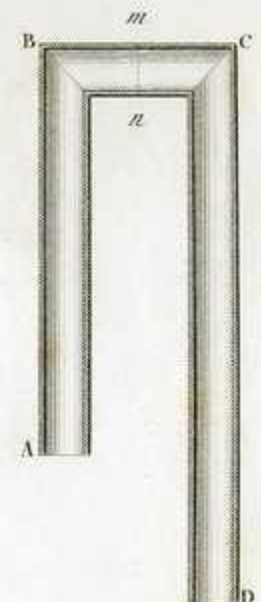
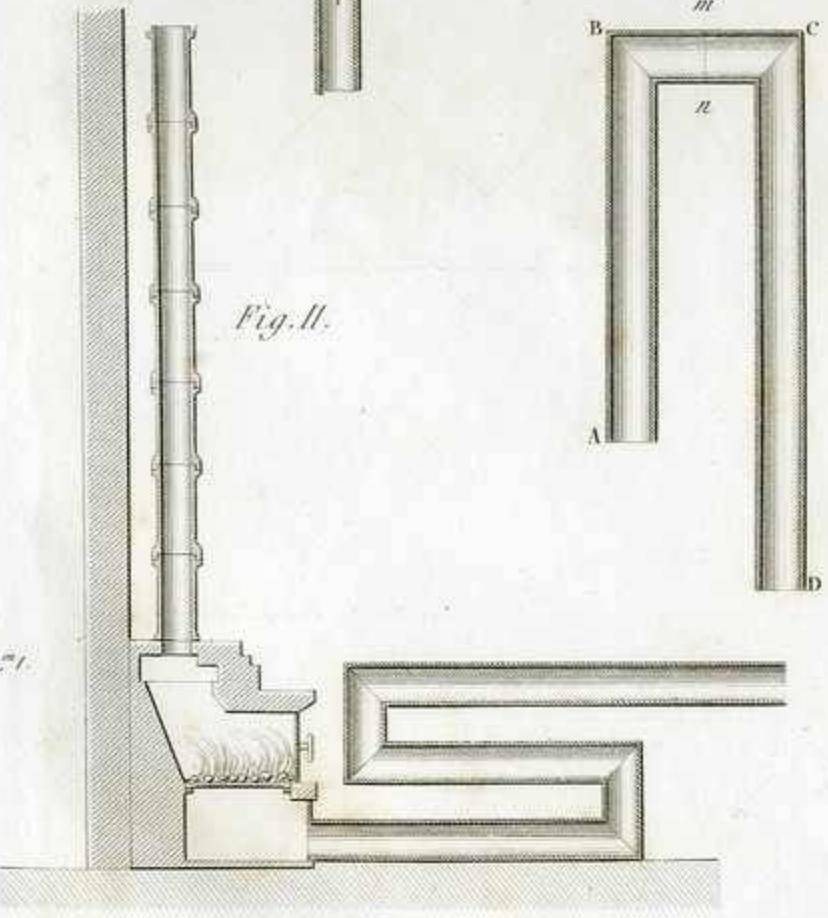
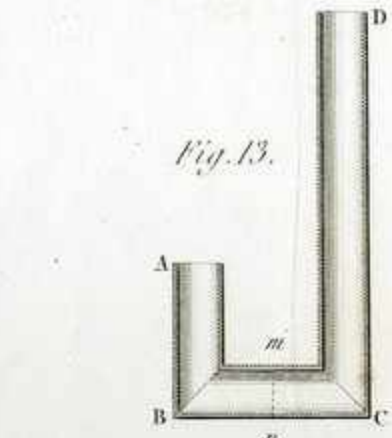
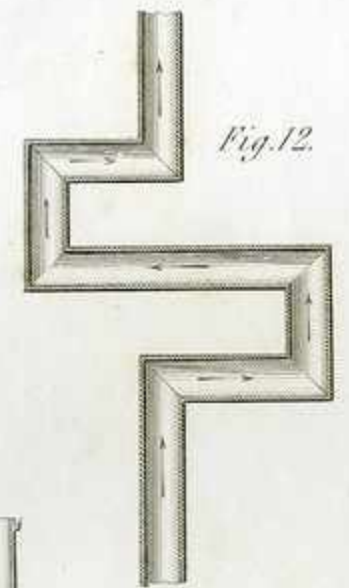
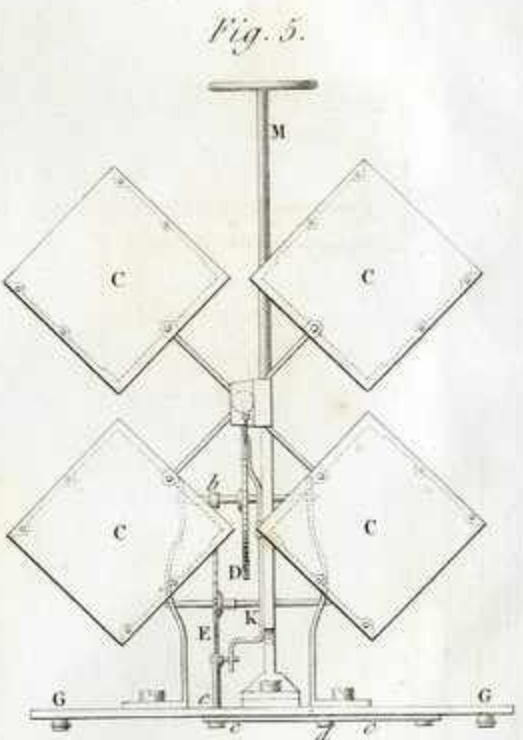
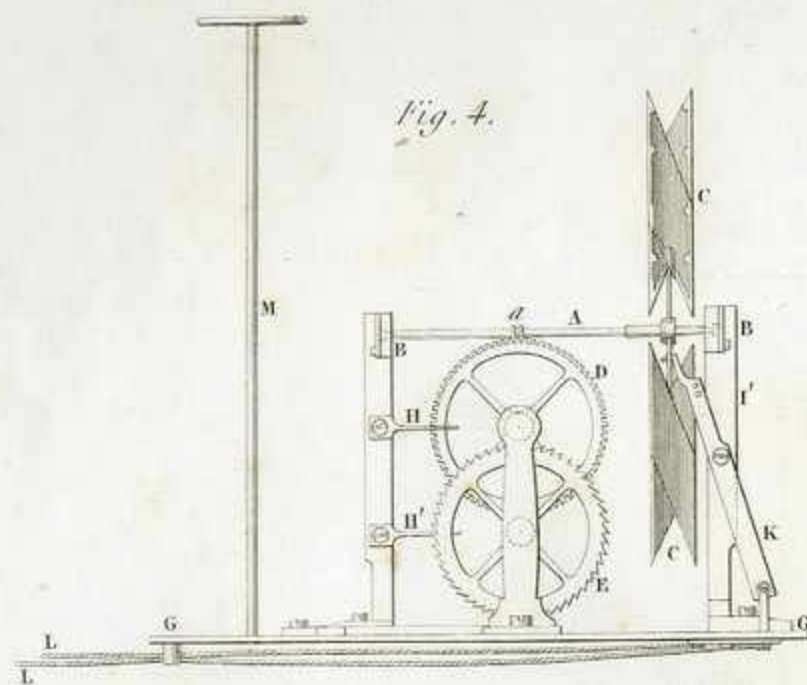
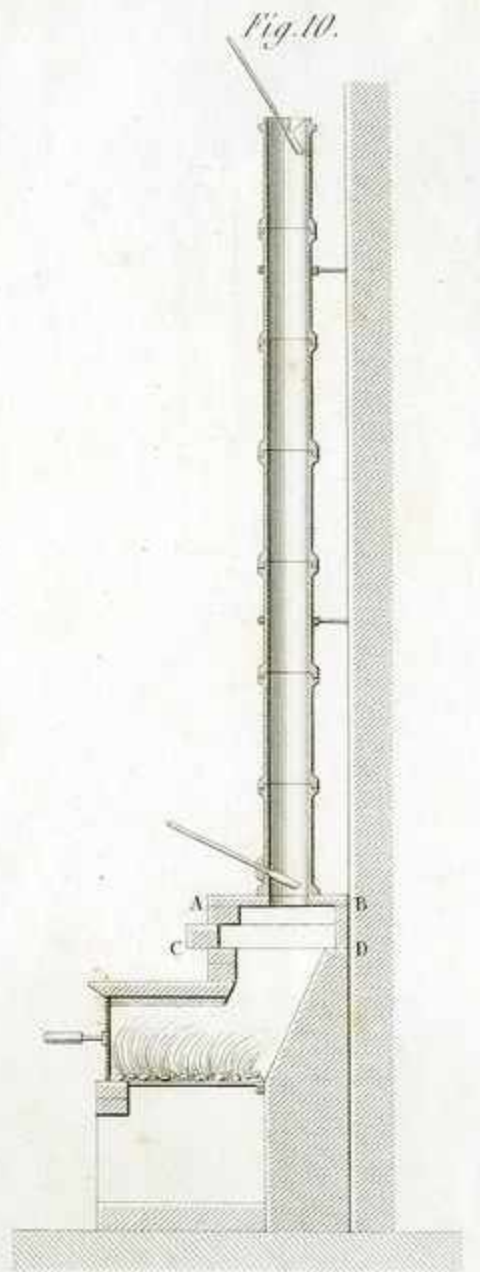
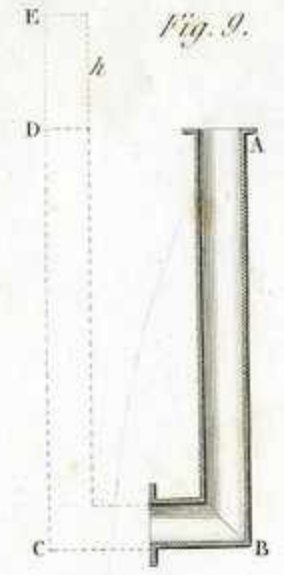
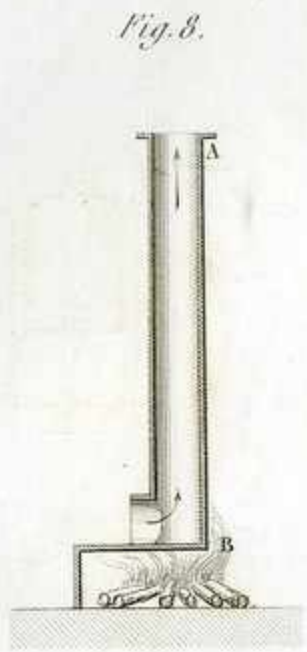
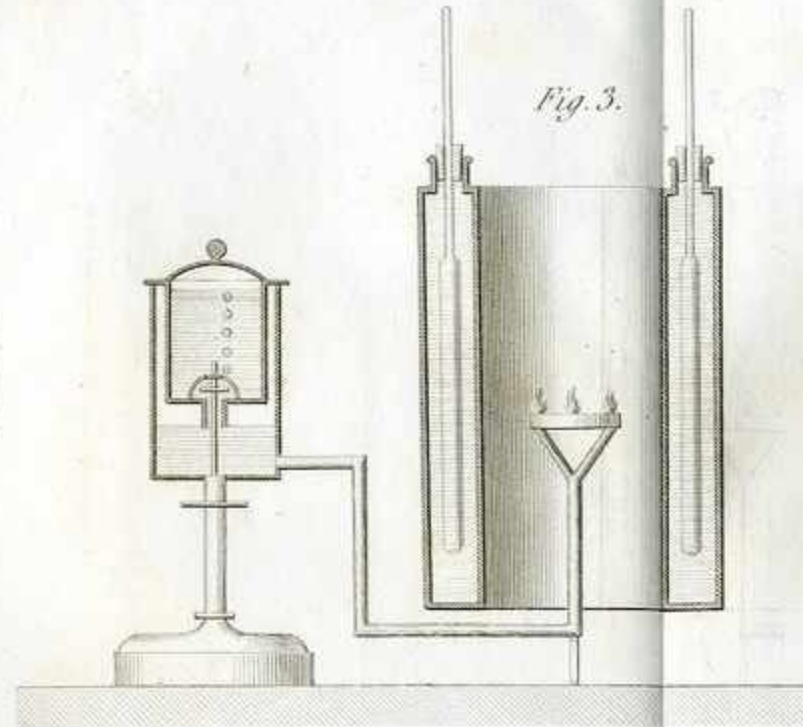
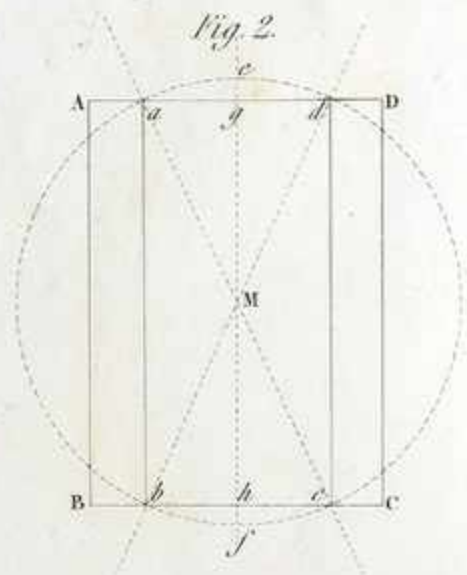
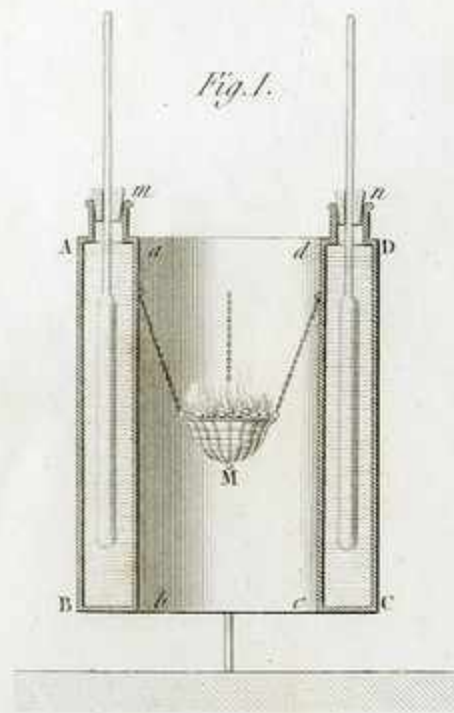
PLANCHES.

PARIS

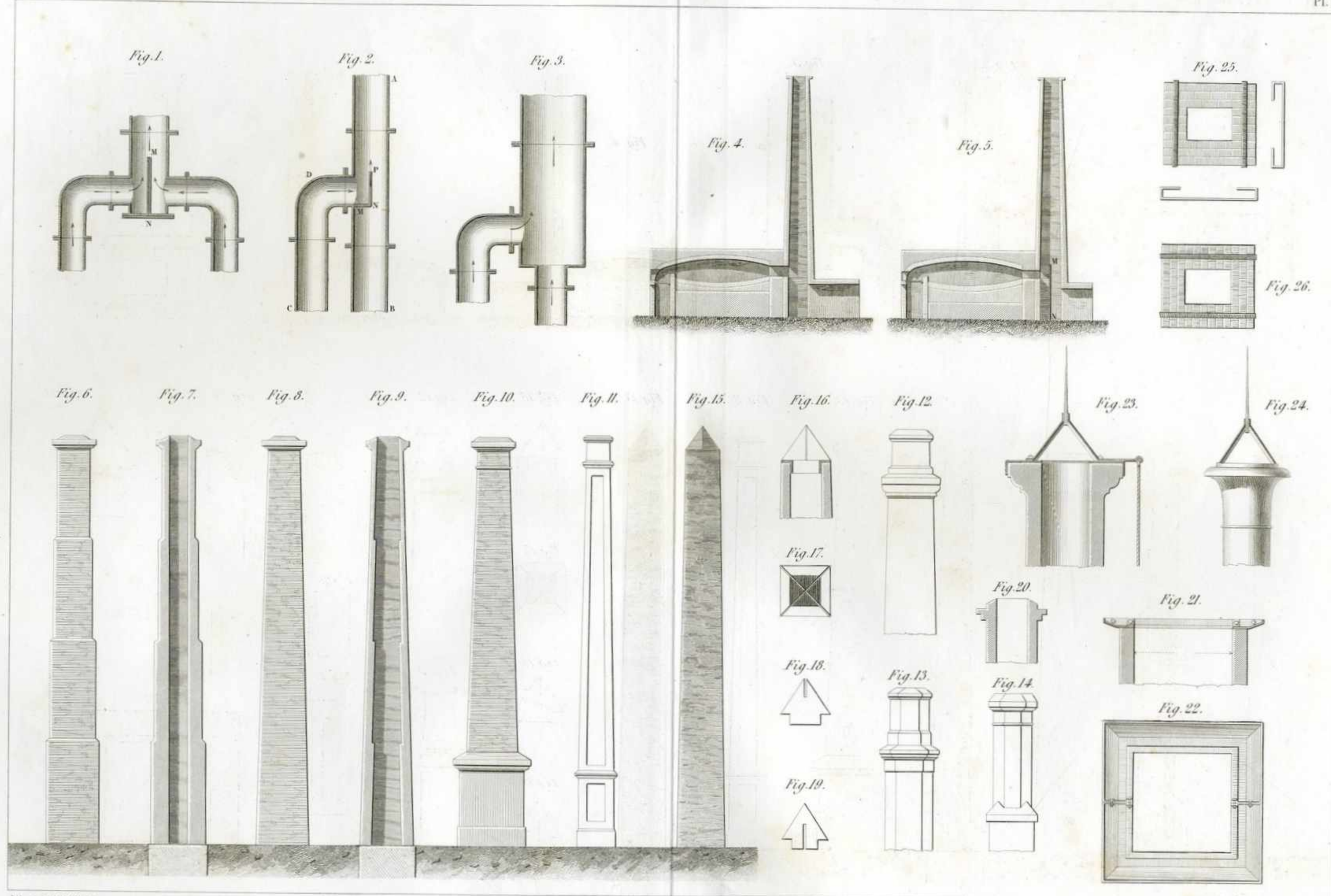
LIBRAIRIE DE L. HACHETTE

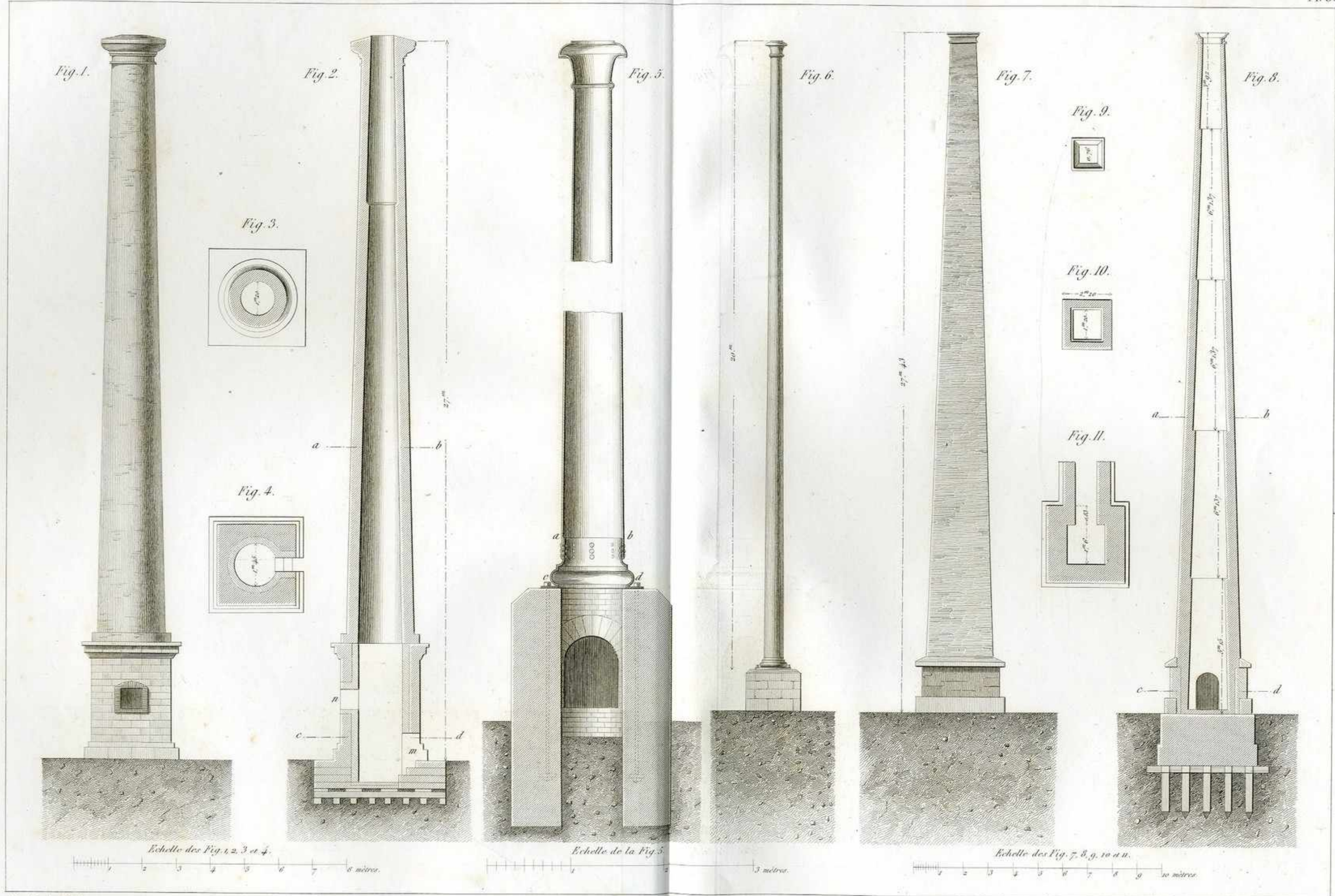
RUE PIERRE-SARRAZIN, 12

1845



Echelle des Fig. 4, 5 et 6.





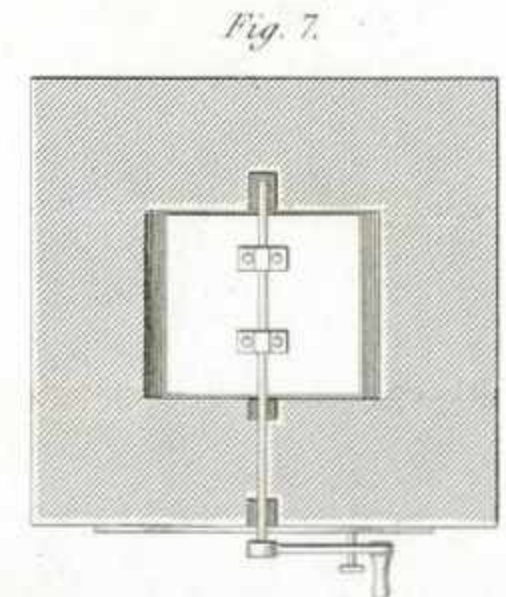
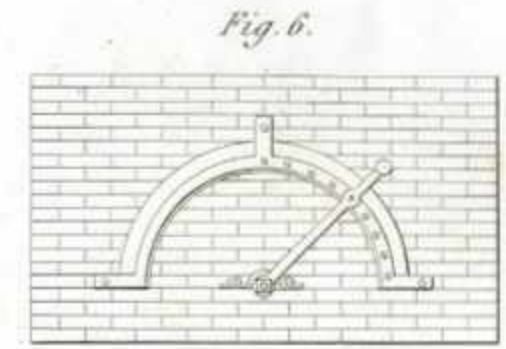
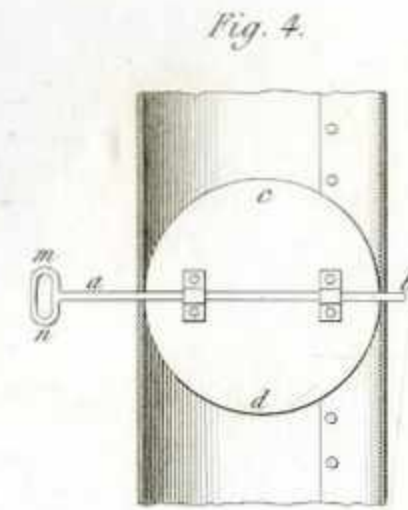
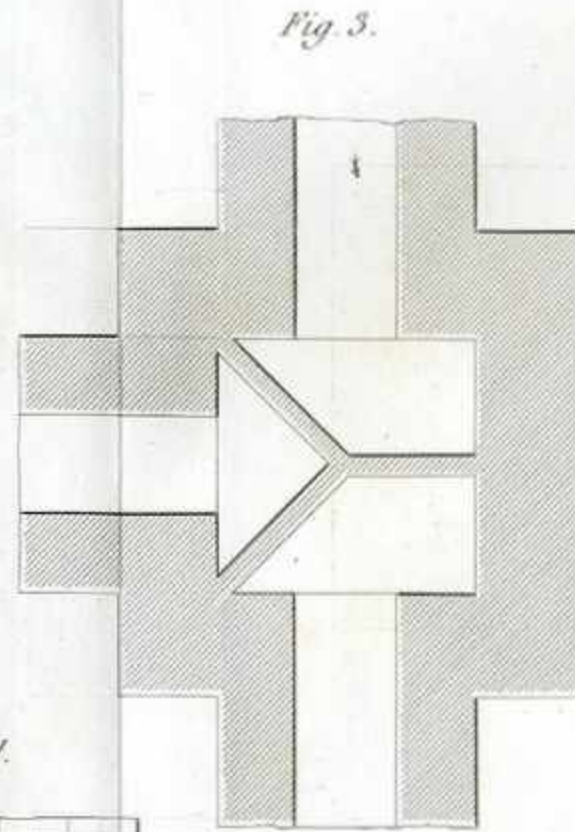
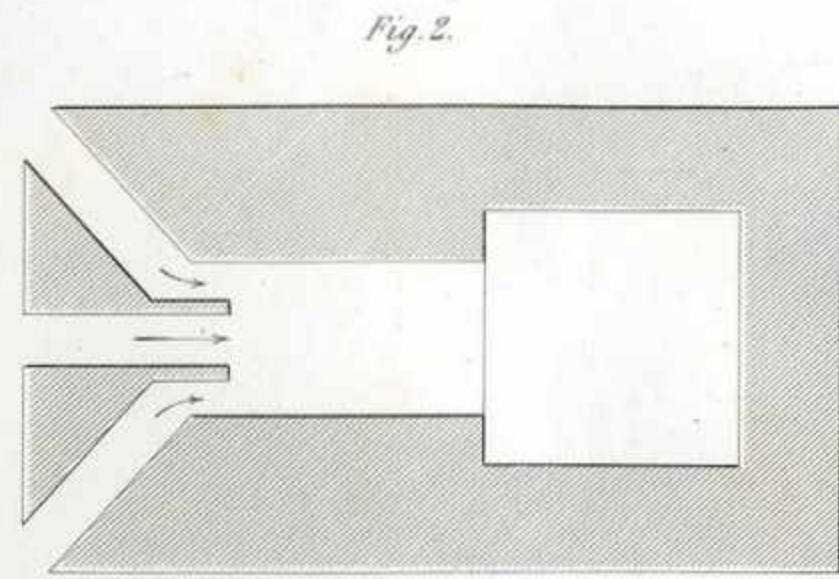
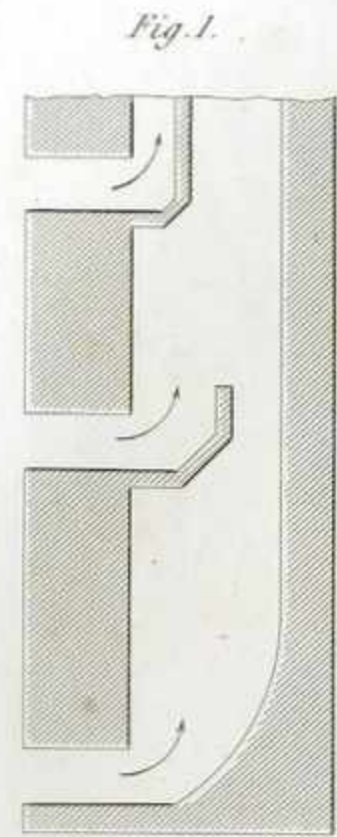


Fig. 8.

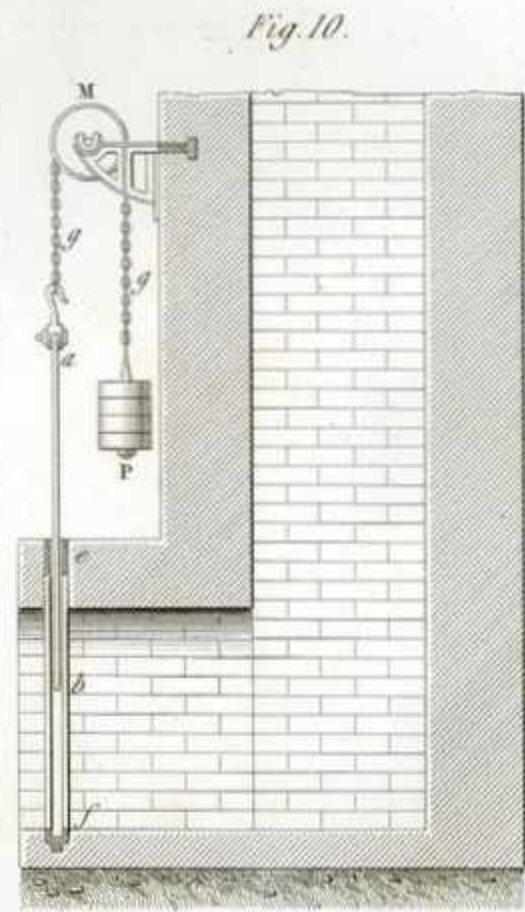


Fig. 10.

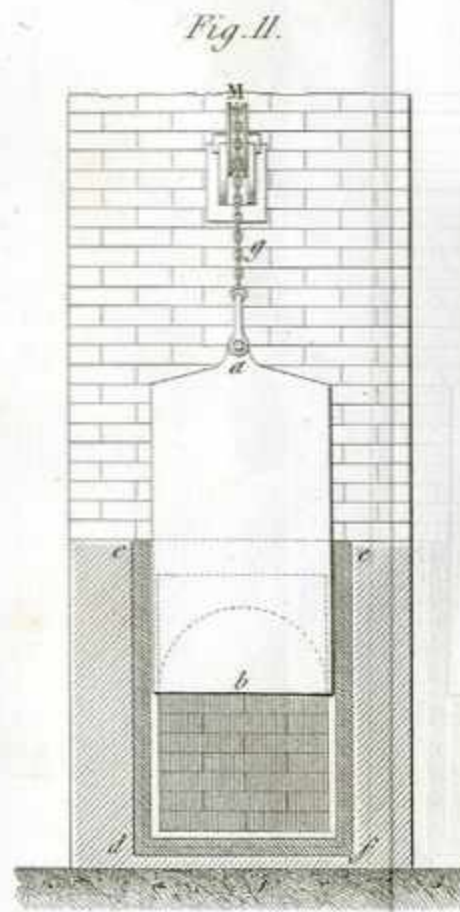


Fig. 11.



Fig. 12.

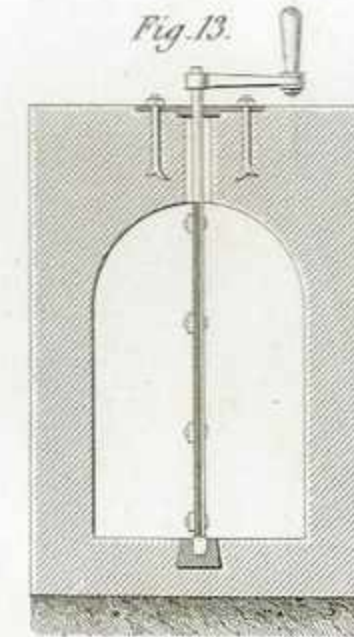


Fig. 13.

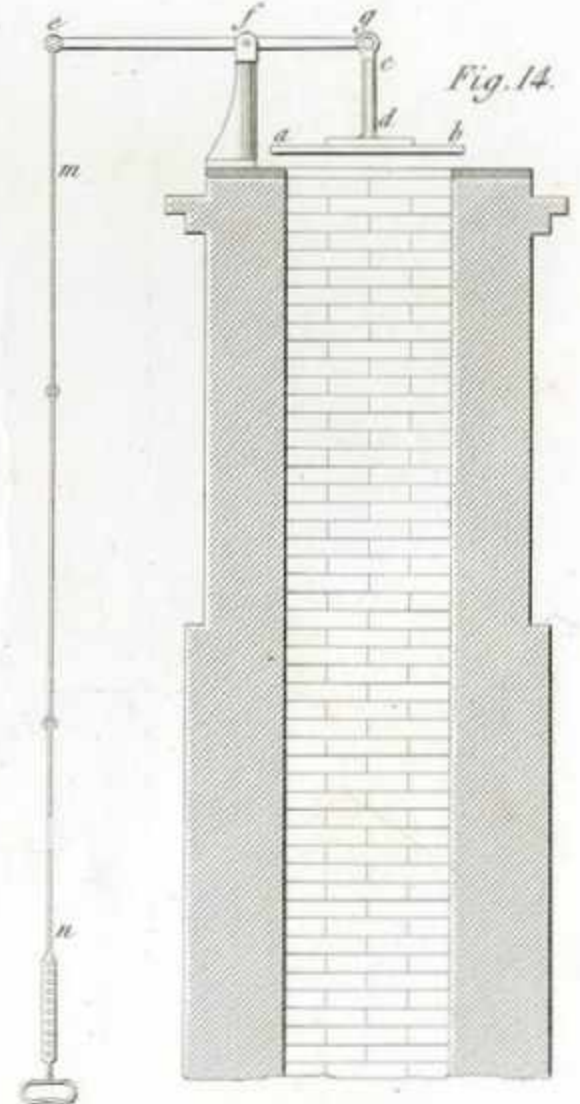


Fig. 14.

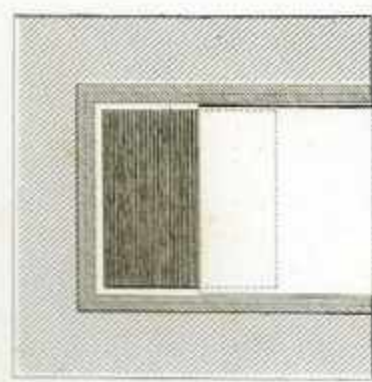


Fig. 9.

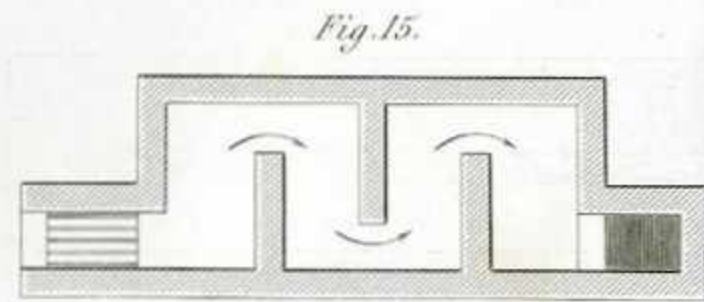


Fig. 15.

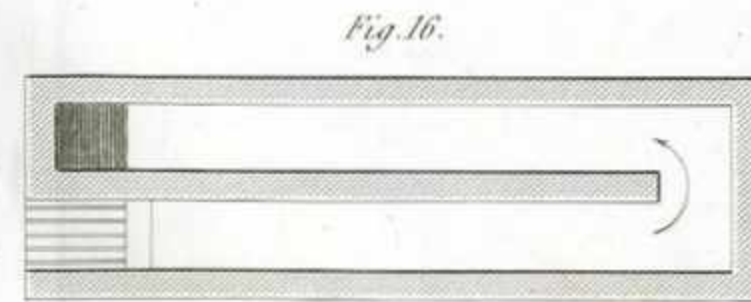


Fig. 16.

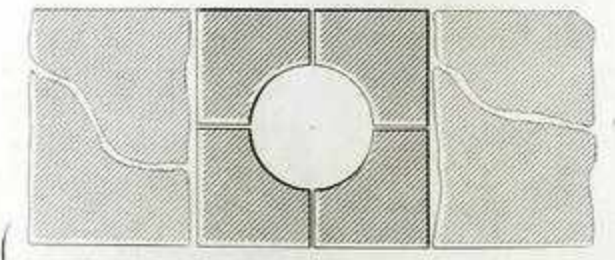


Fig. 1.

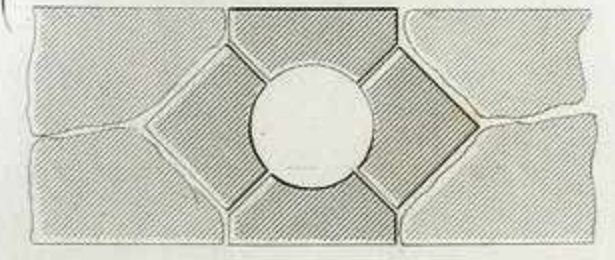


Fig. 5.

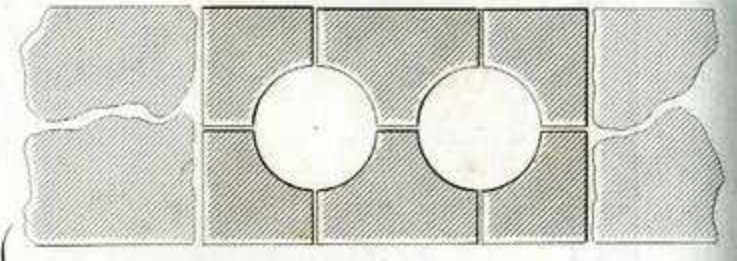


Fig. 2.

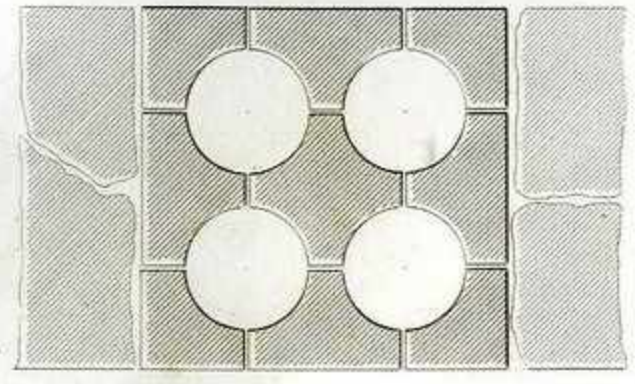
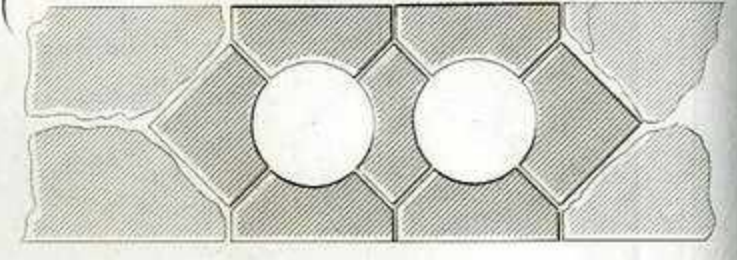


Fig. 3.

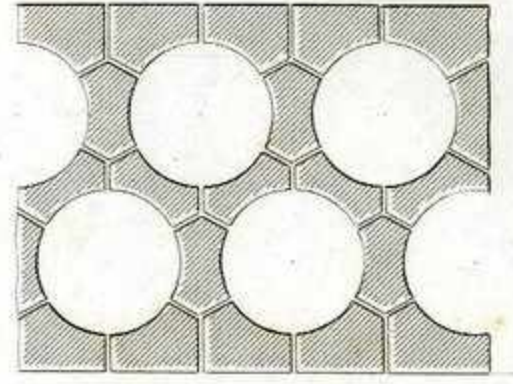
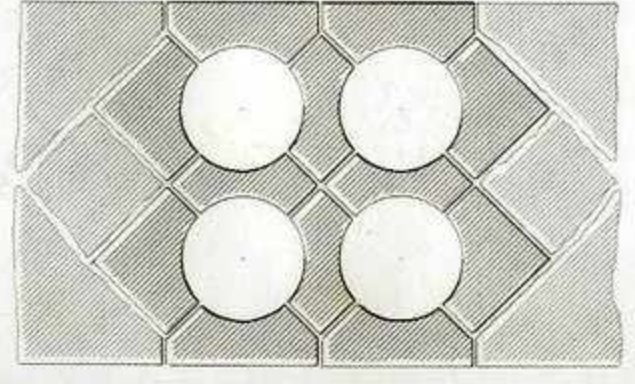


Fig. 4.

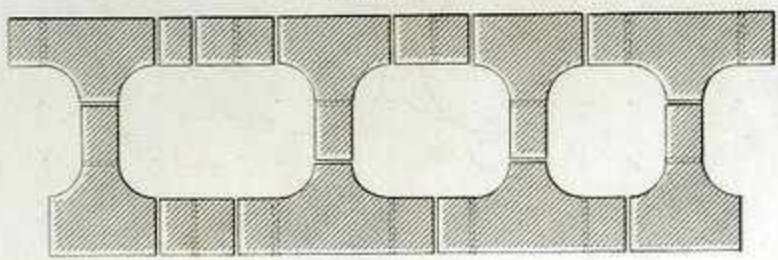
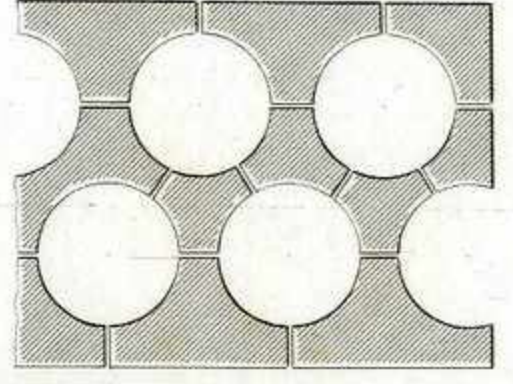


Fig. 6.

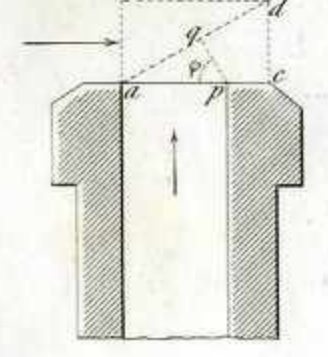


Fig. 7.

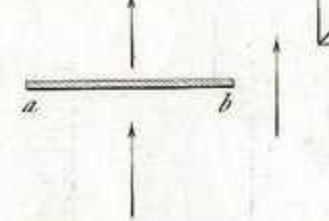


Fig. 8.

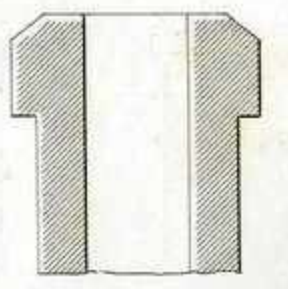


Fig. 9.

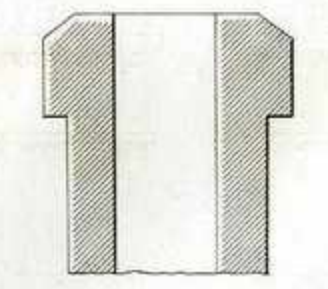


Fig. 10.



Fig. 11.

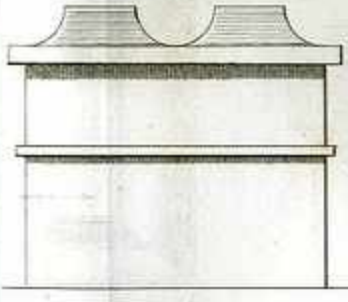


Fig. 12.

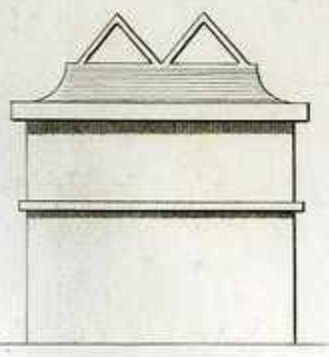


Fig. 13.

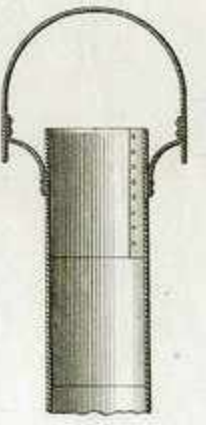


Fig. 14.

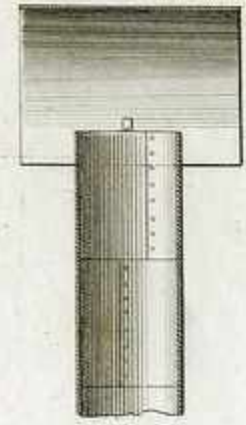


Fig. 15.

Fig. 16.

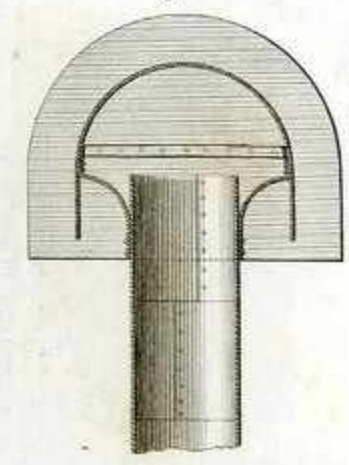


Fig. 17.

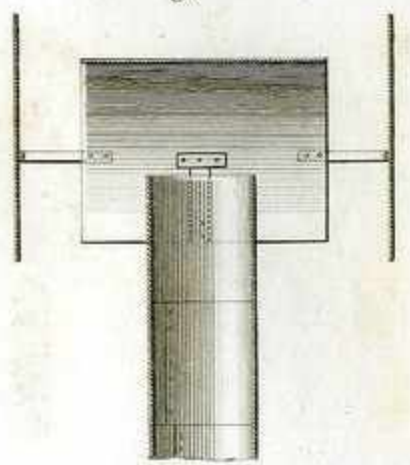


Fig. 18.

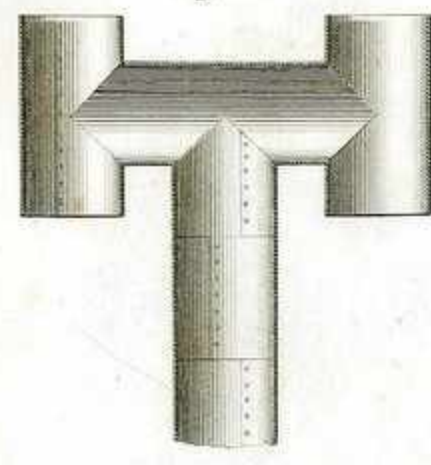


Fig. 19.

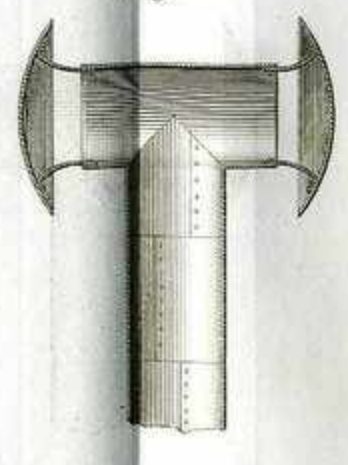


Fig. 20.

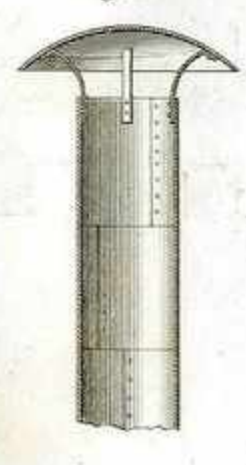


Fig. 21.

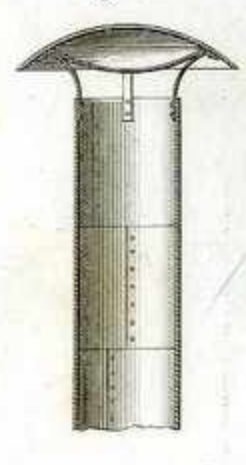


Fig. 22.

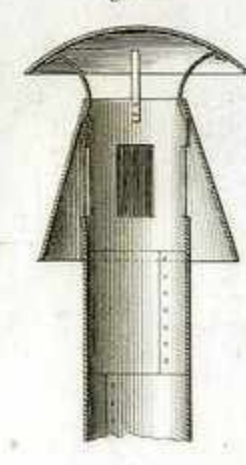
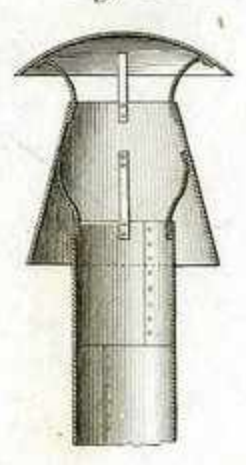
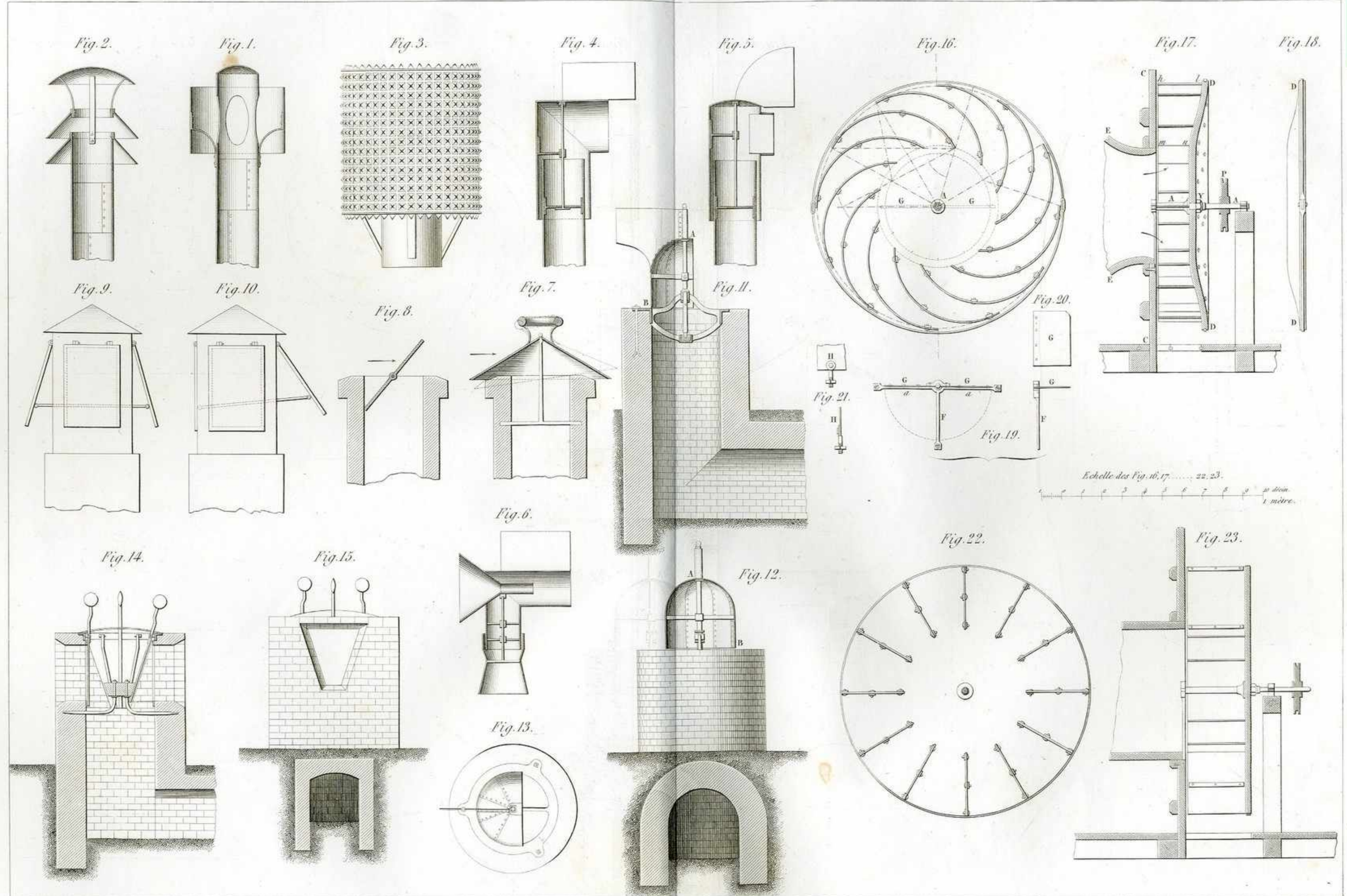


Fig. 23.





Echelle des Fig. 16, 17, 22, 23.
10 décimètres
1 mètre.

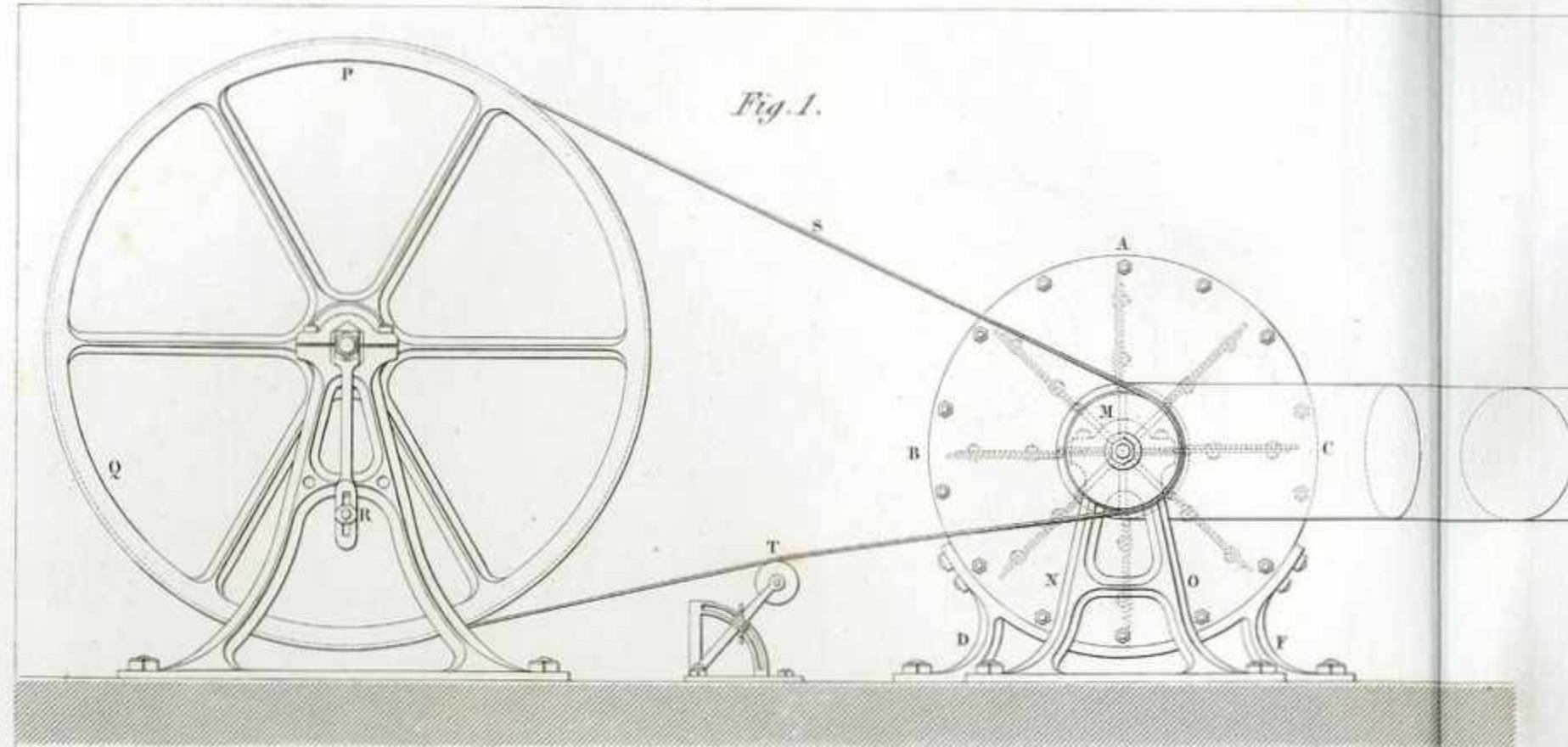
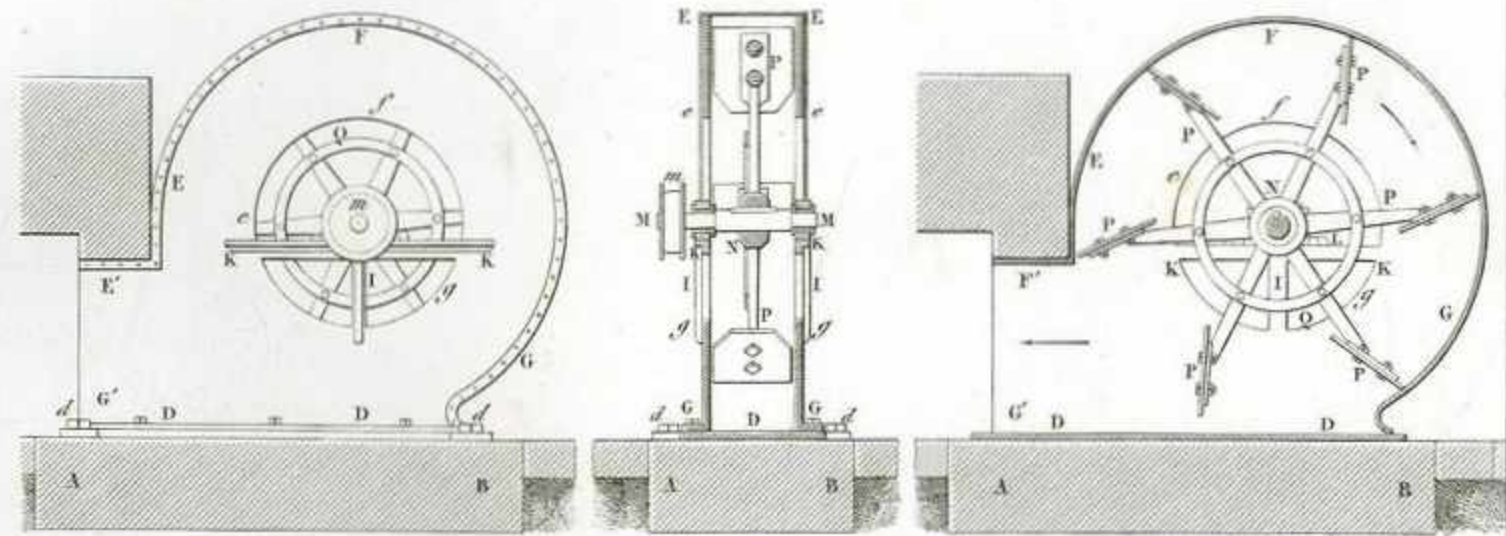


Fig. 1.

Fig. 8.

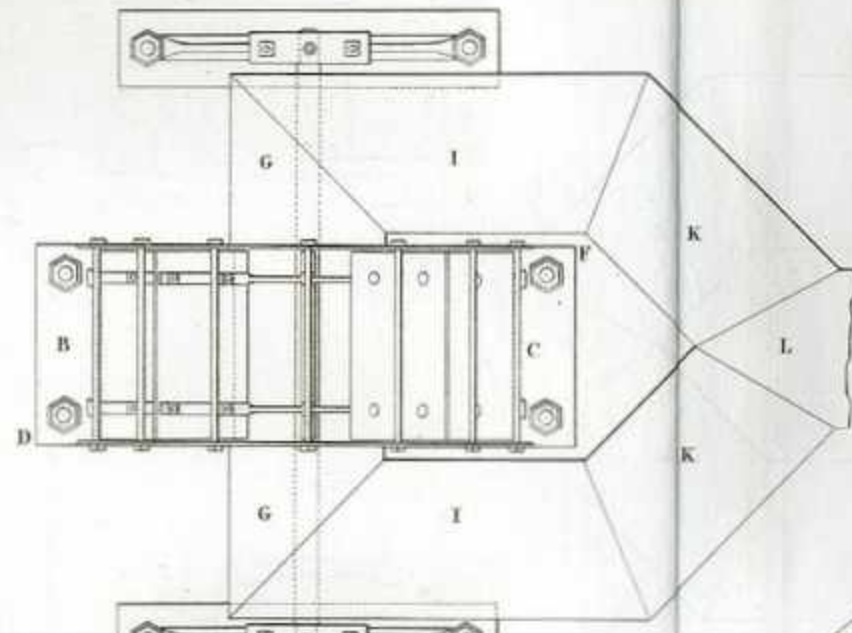
Fig. 9.

Fig. 10.



Echelle des Fig. 1 et 2.
10 décim.
1 mètre

Fig. 2.



Echelle des Fig. 8, 9, 10, 11, 12.

Echelle des Fig. 13 et 14.

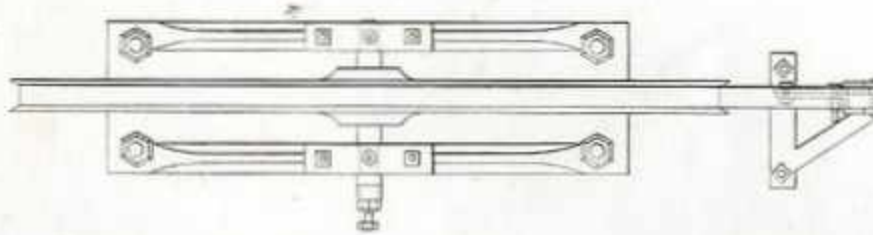
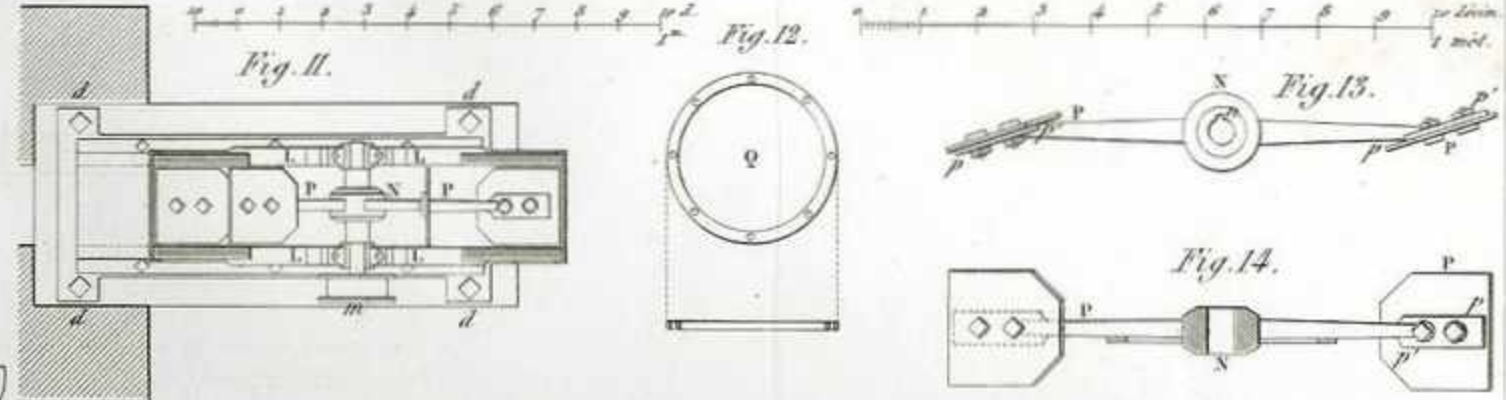


Fig. 3.

Fig. 4.

Fig. 5.

Fig. 6.

Fig. 7.

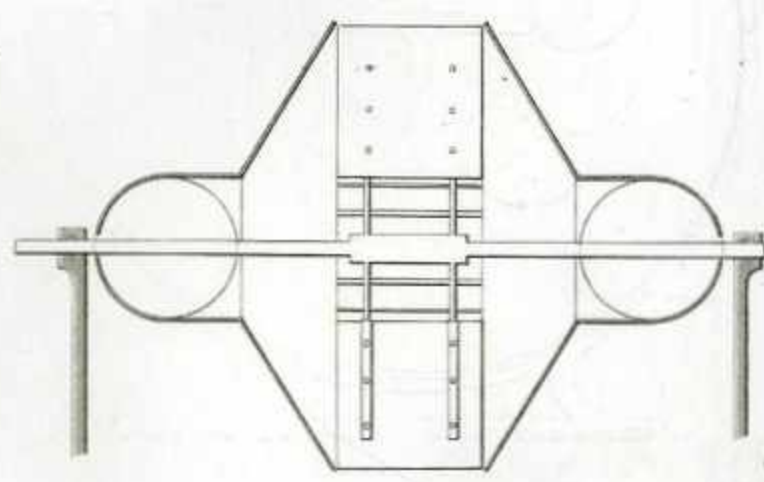
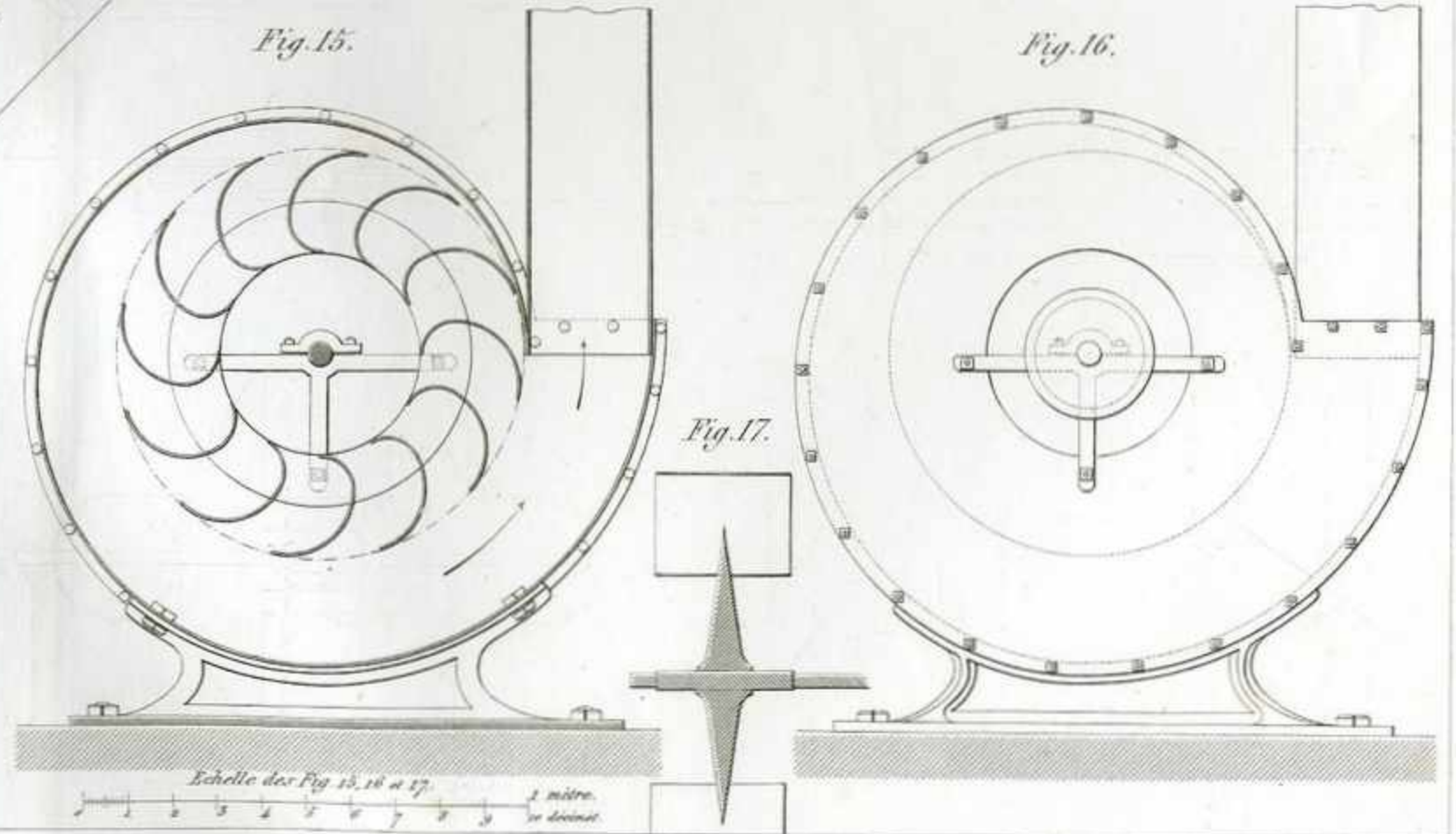
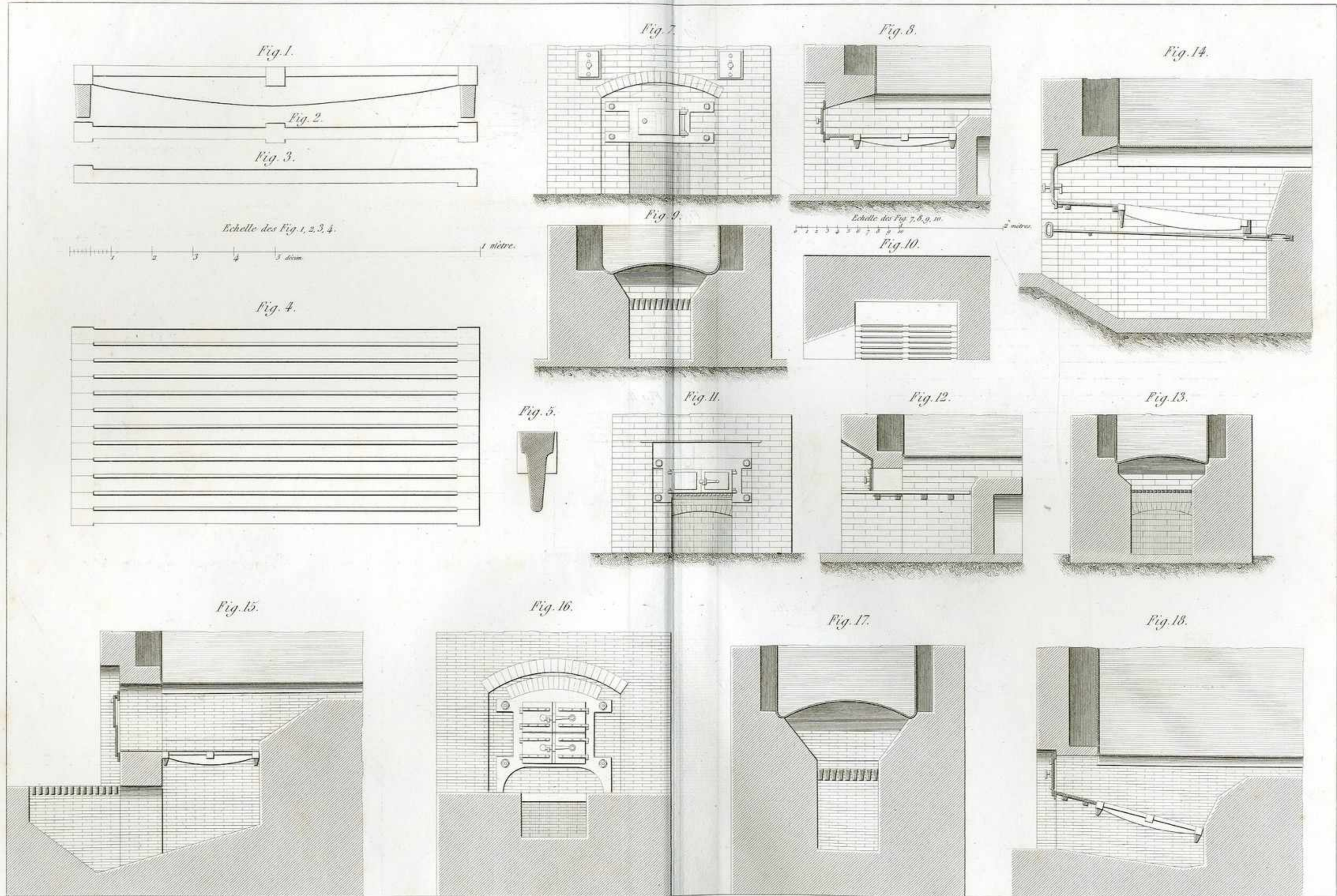


Fig. 15.

Fig. 16.



Echelle des Fig. 15, 16 et 17.
1 mètre
10 décim.



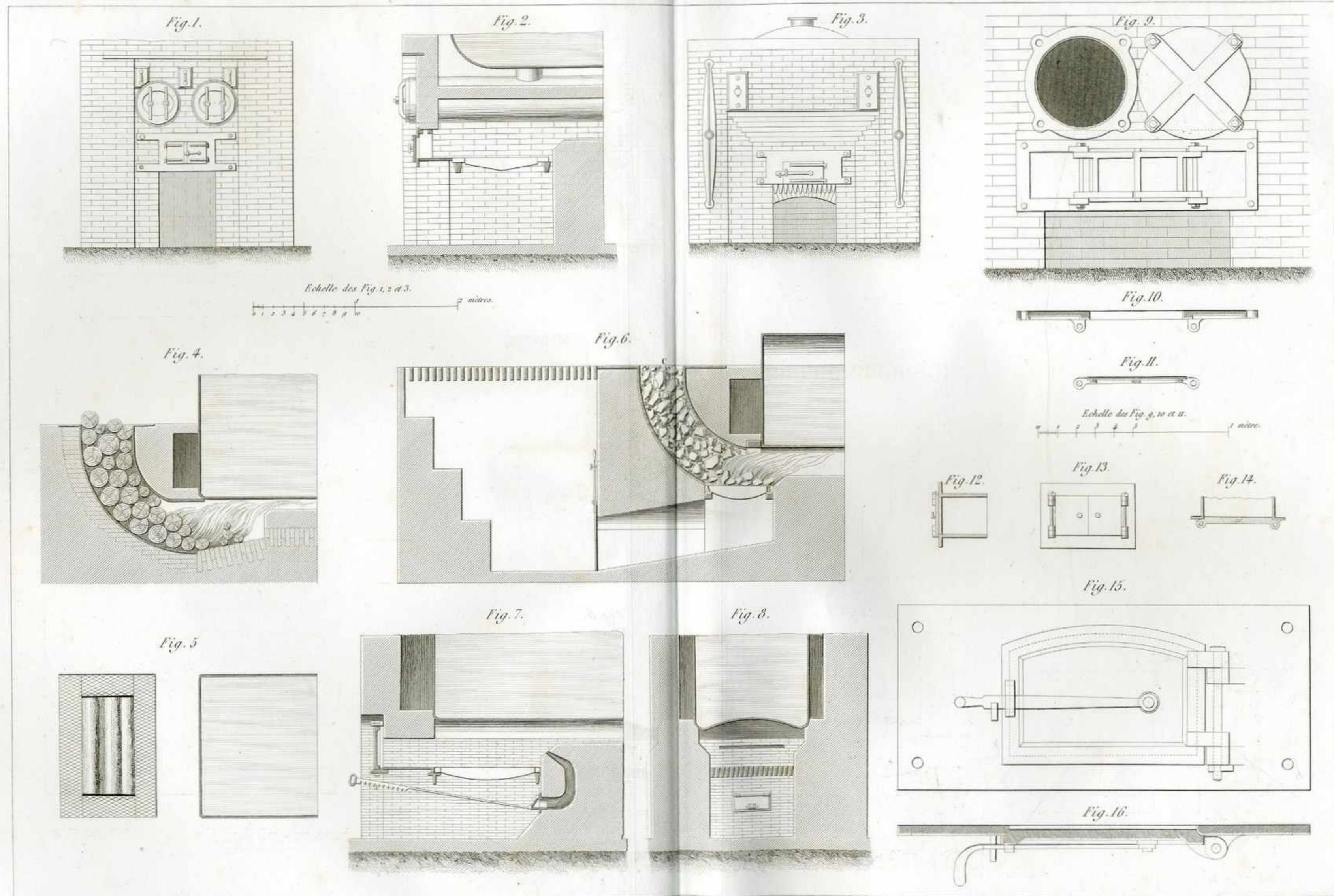


Fig. 1.

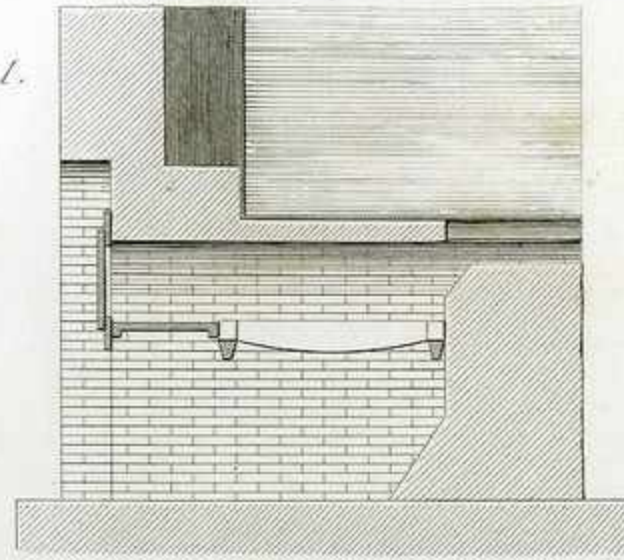


Fig. 3.

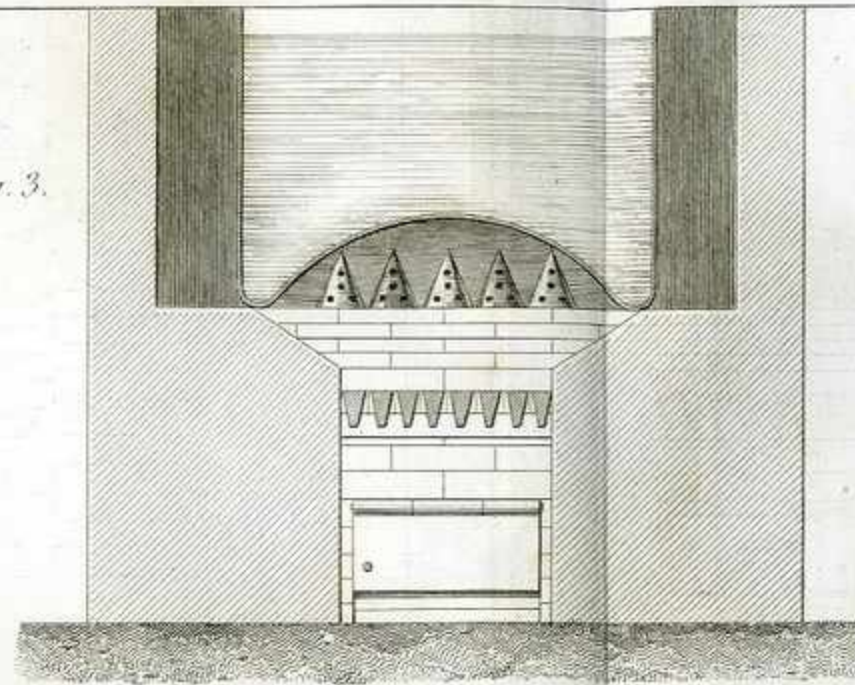


Fig. 4.

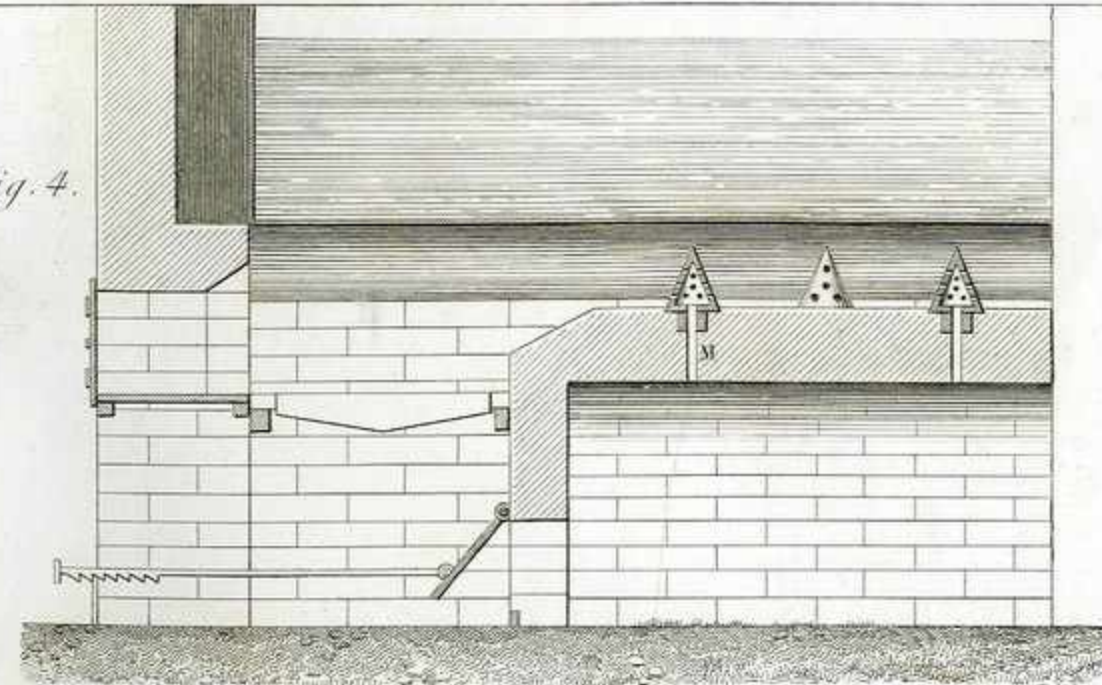


Fig. 2.

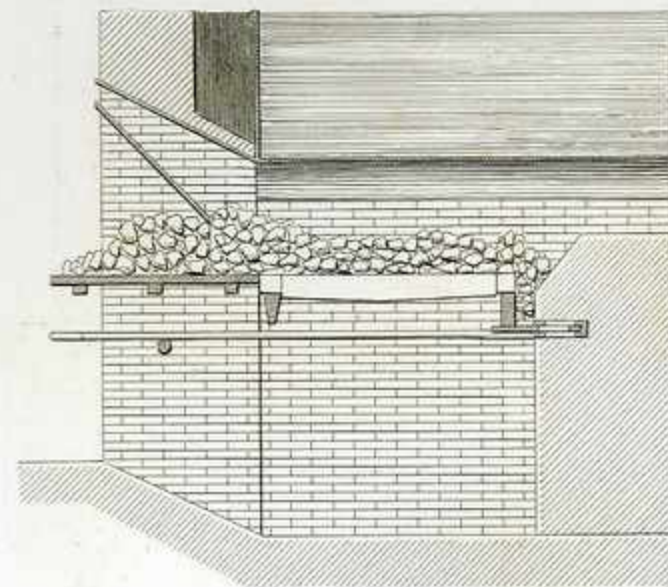


Fig. 5.

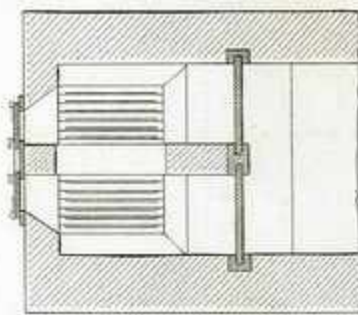
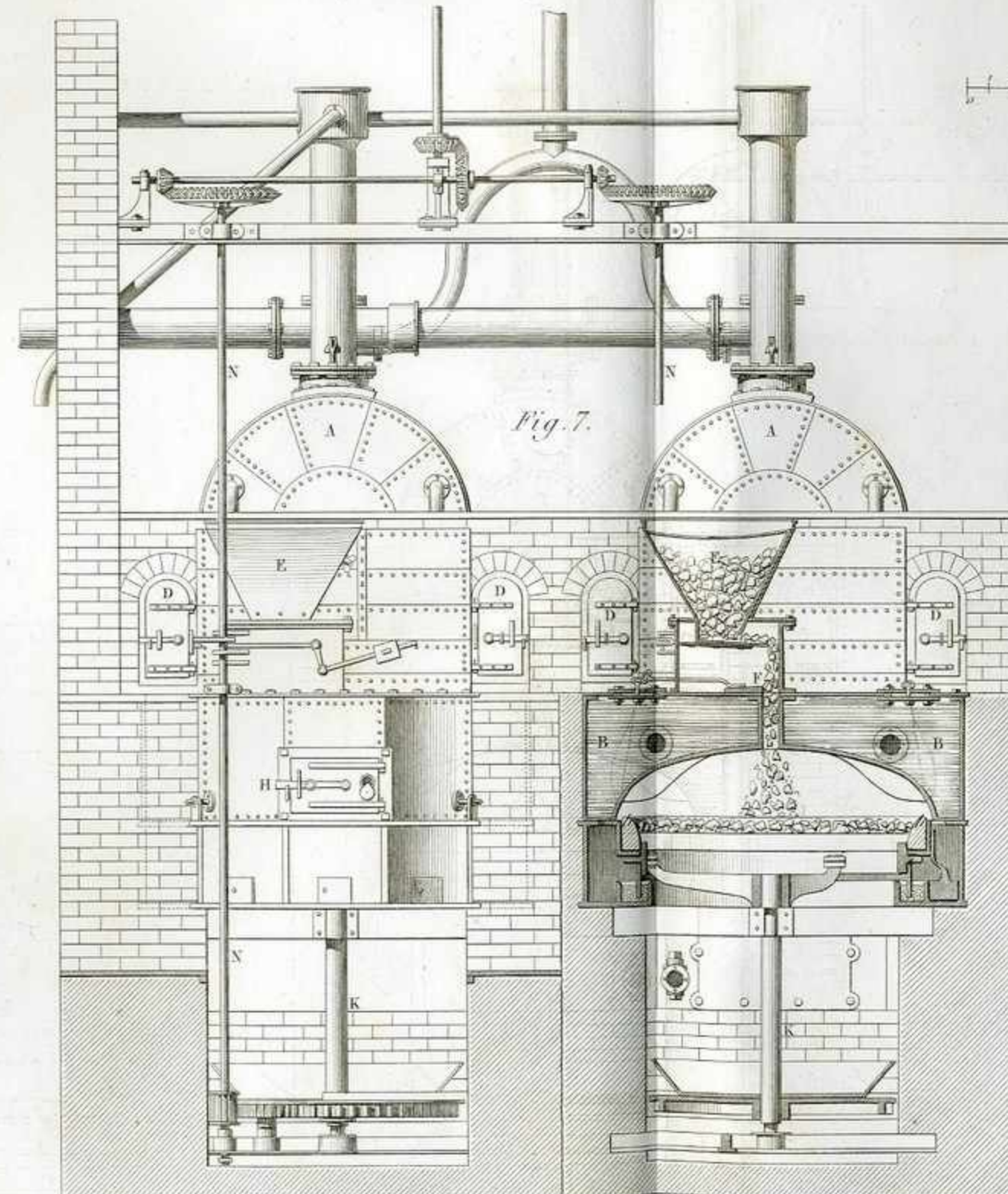
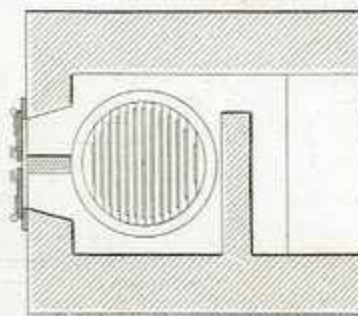
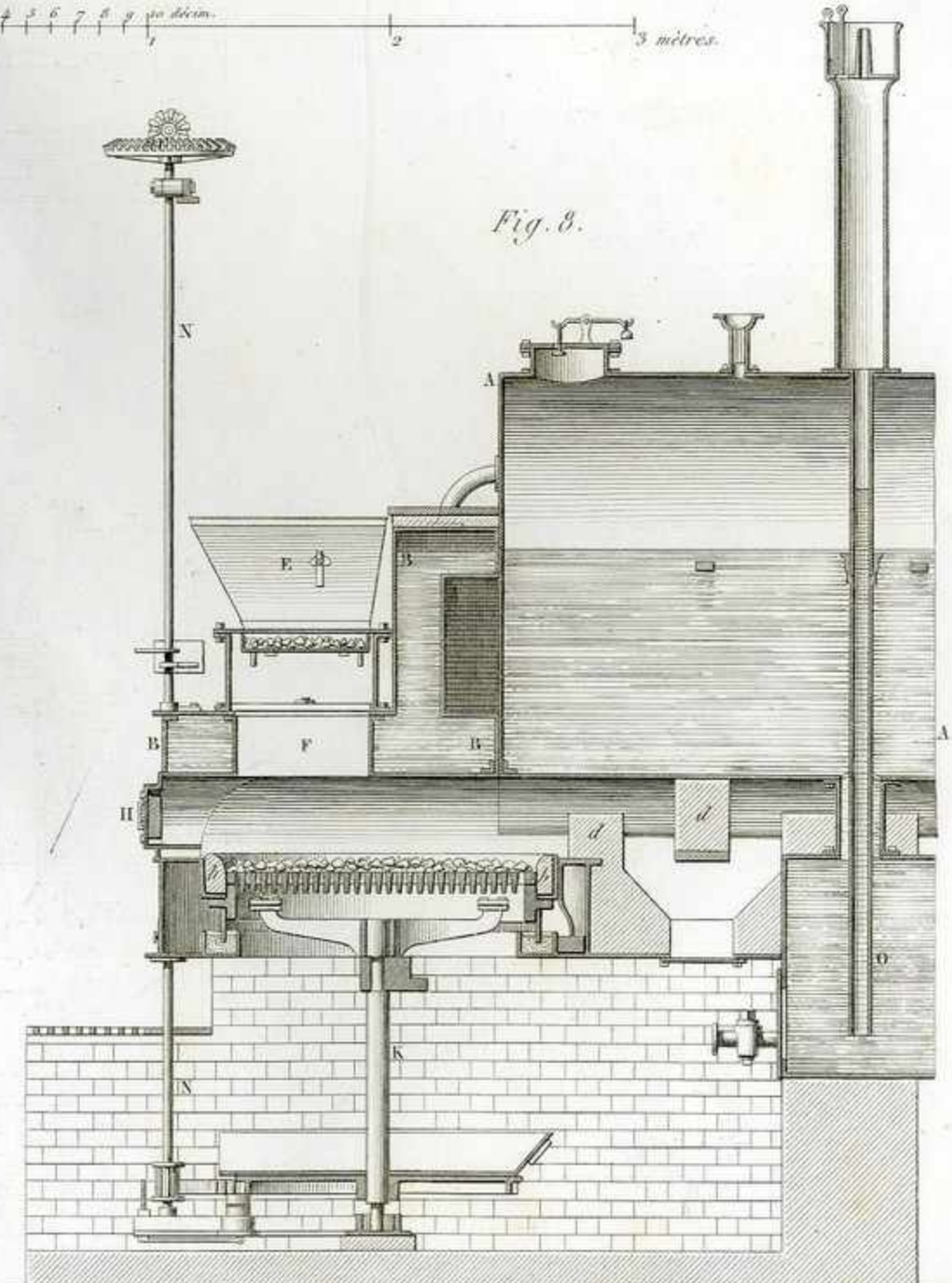


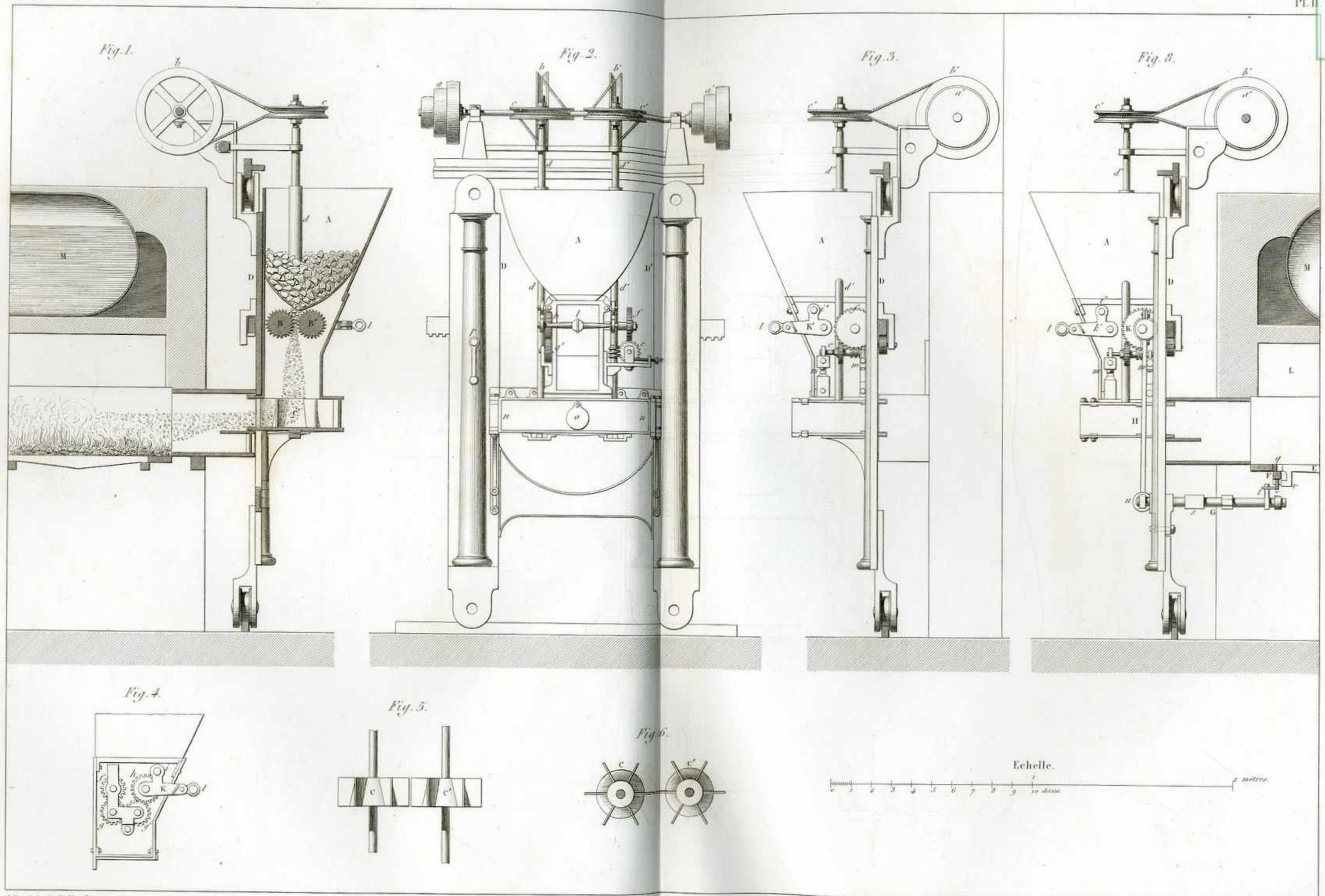
Fig. 6.

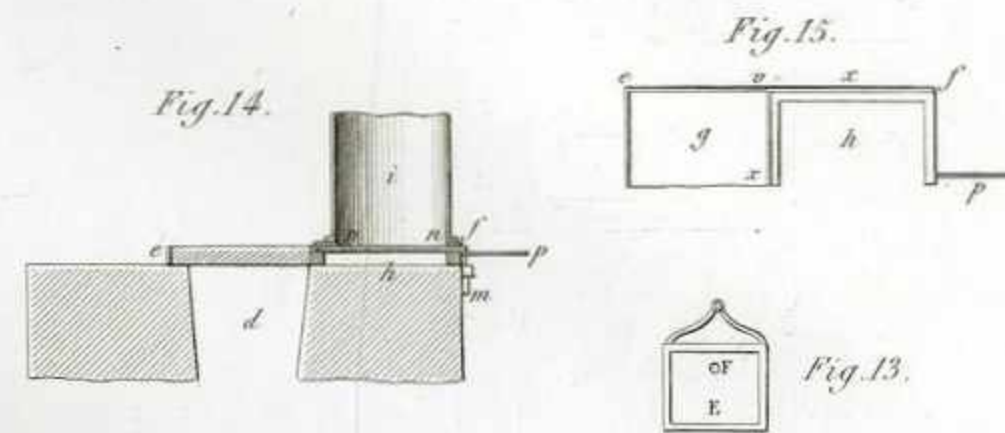
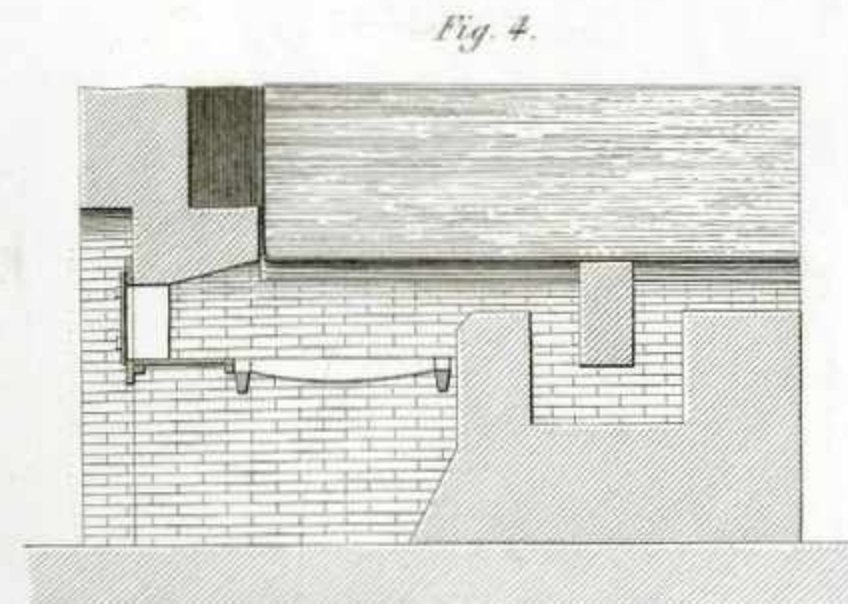
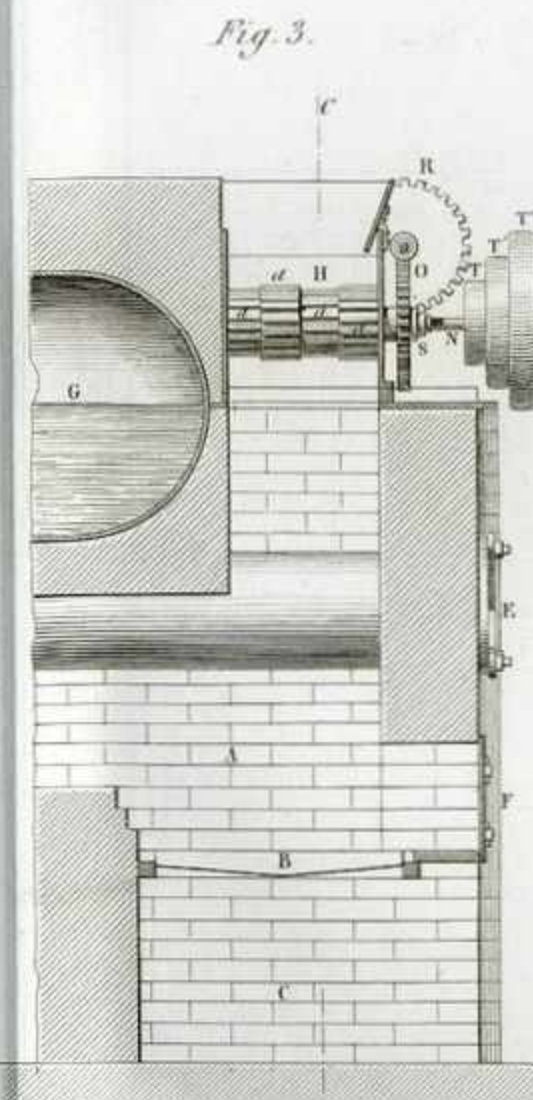
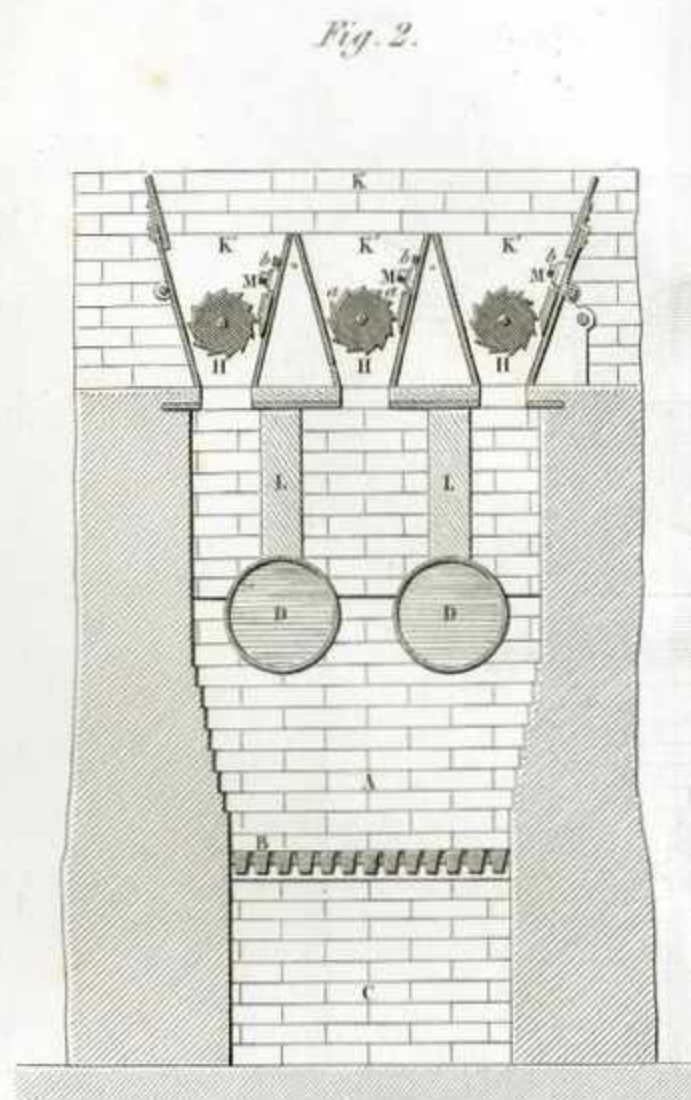
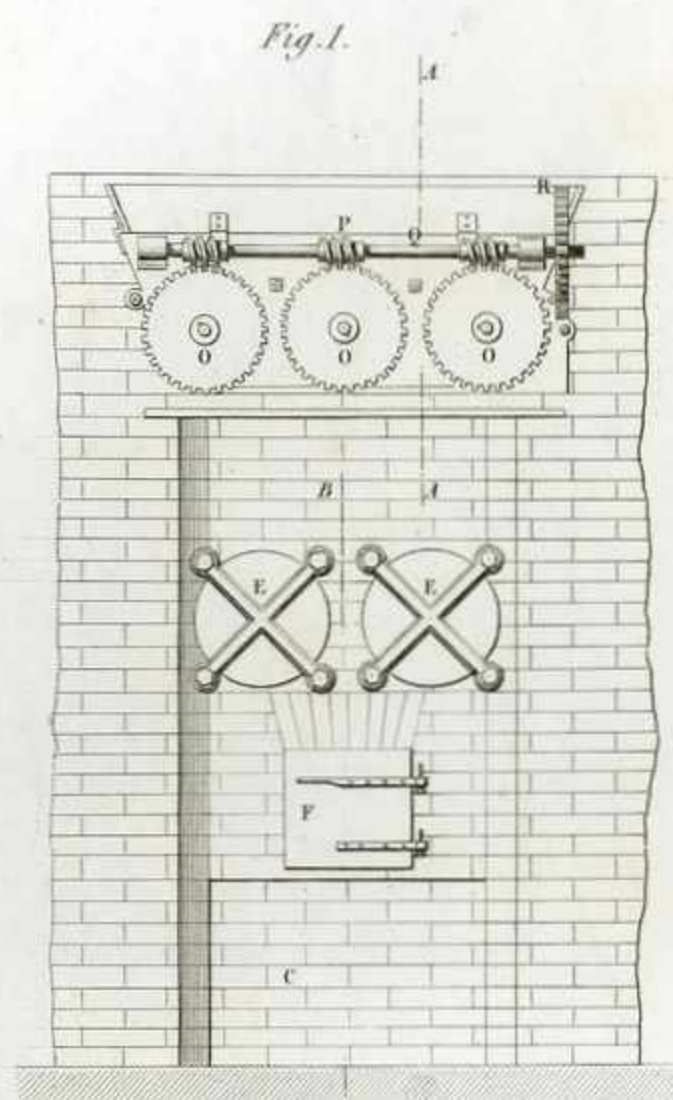


Echelle des Fig. 7 et 8.
0 1 2 3 4 5 6 7 8 9 10
1/2 mètres.

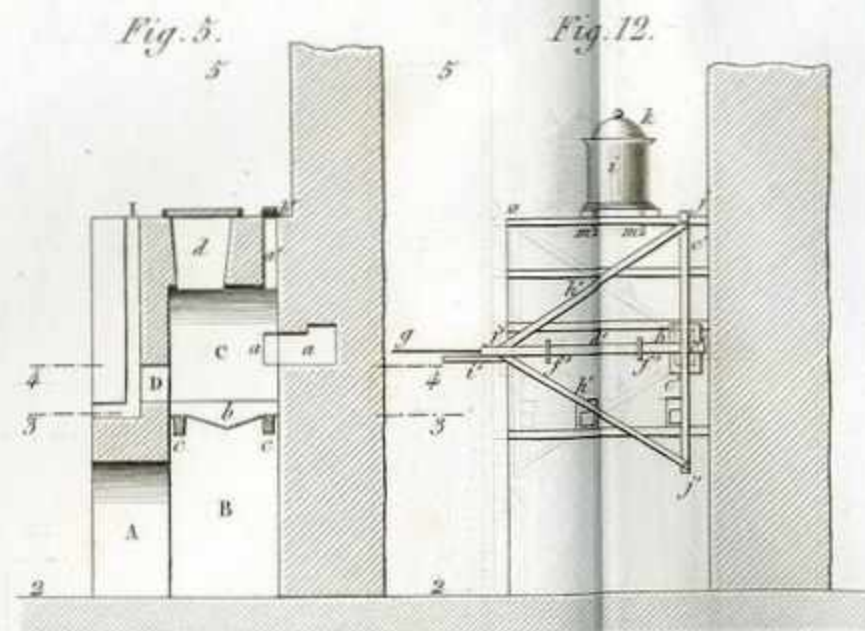
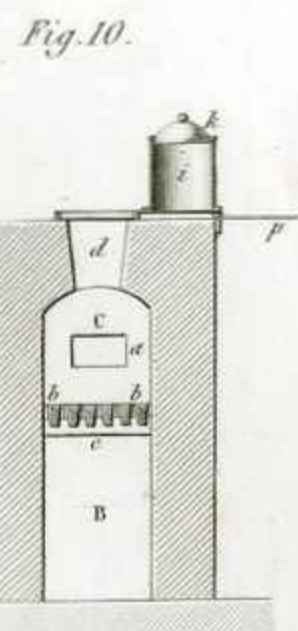
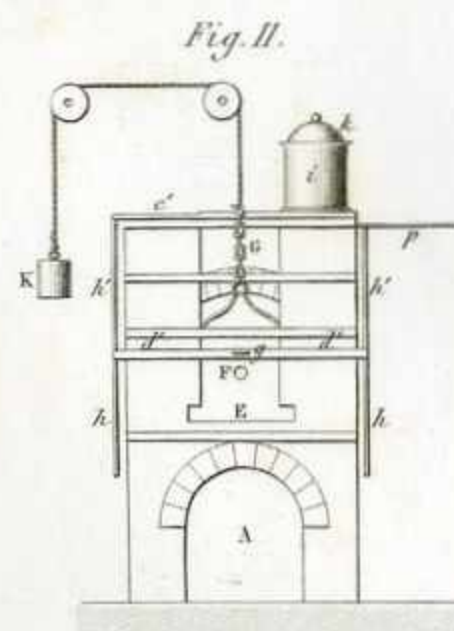
Fig. 8.



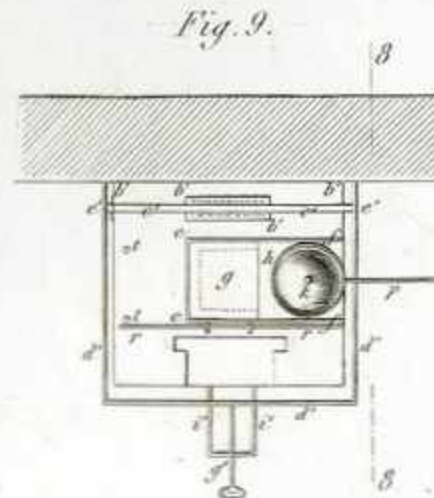
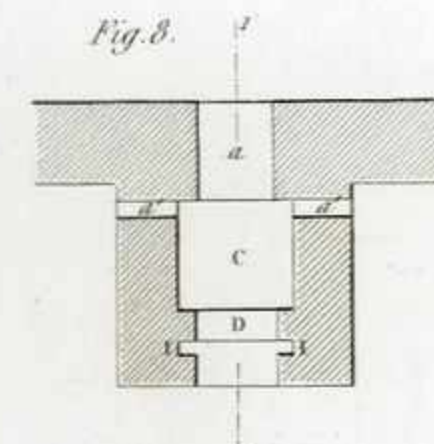
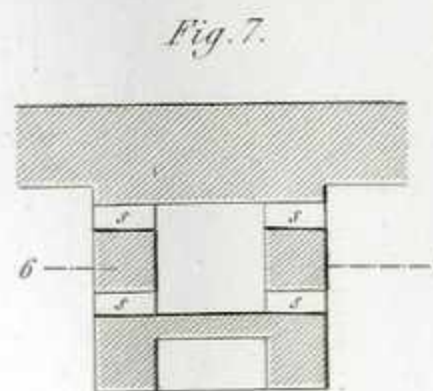
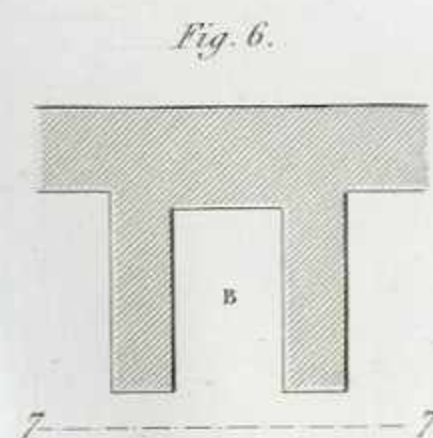


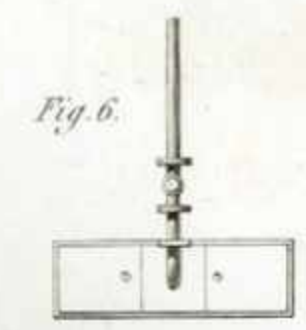
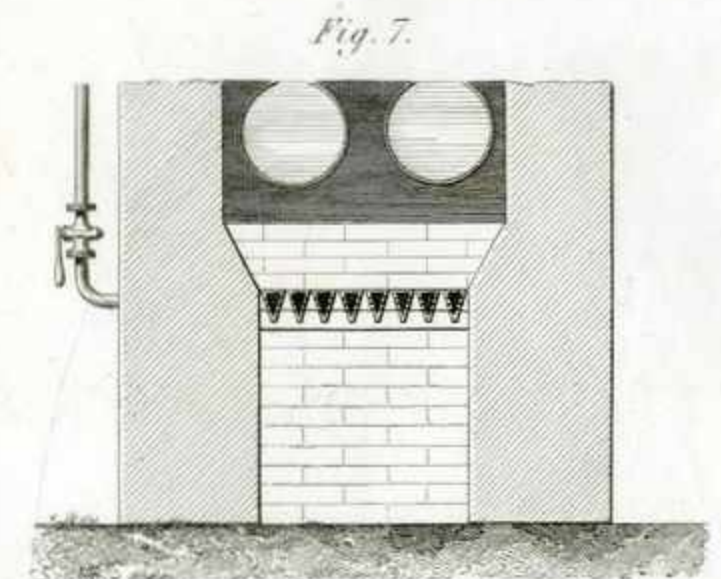
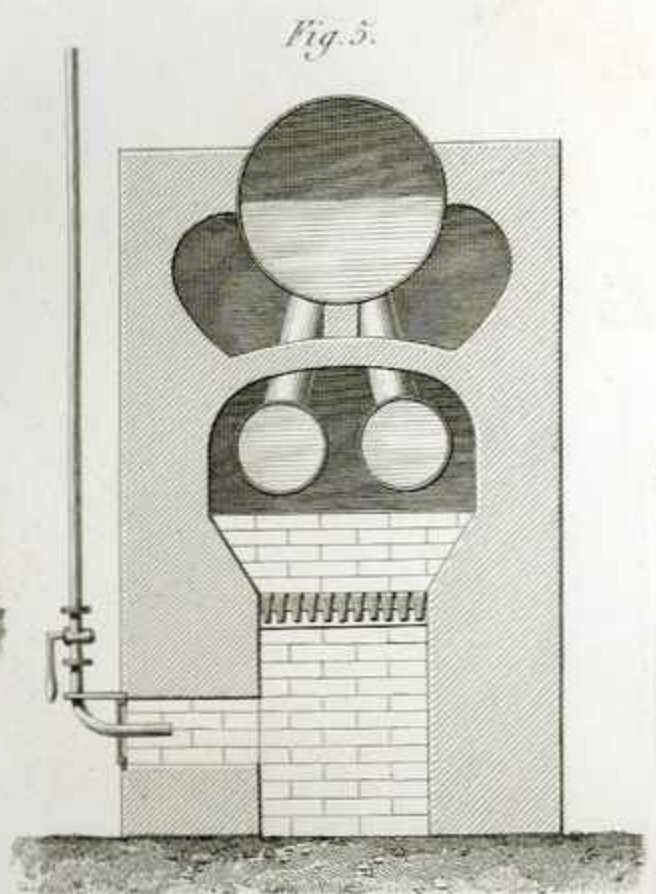
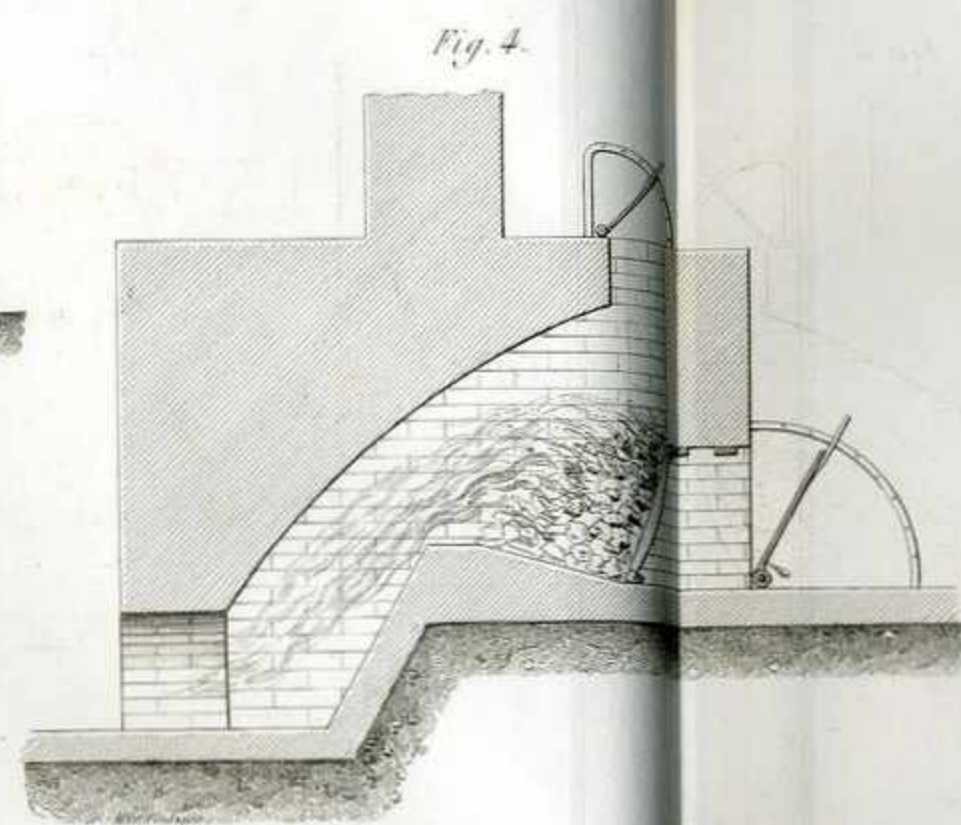
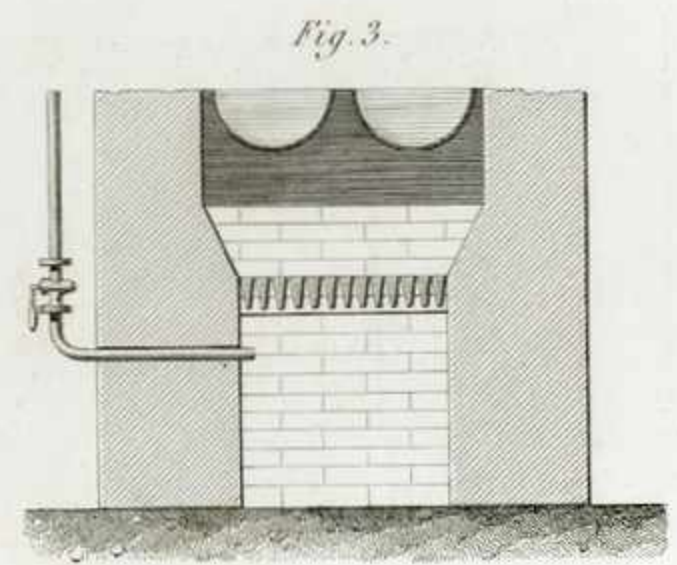
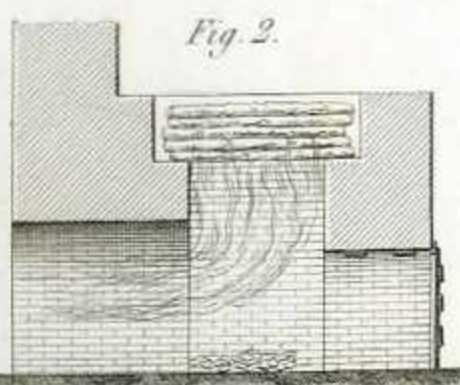
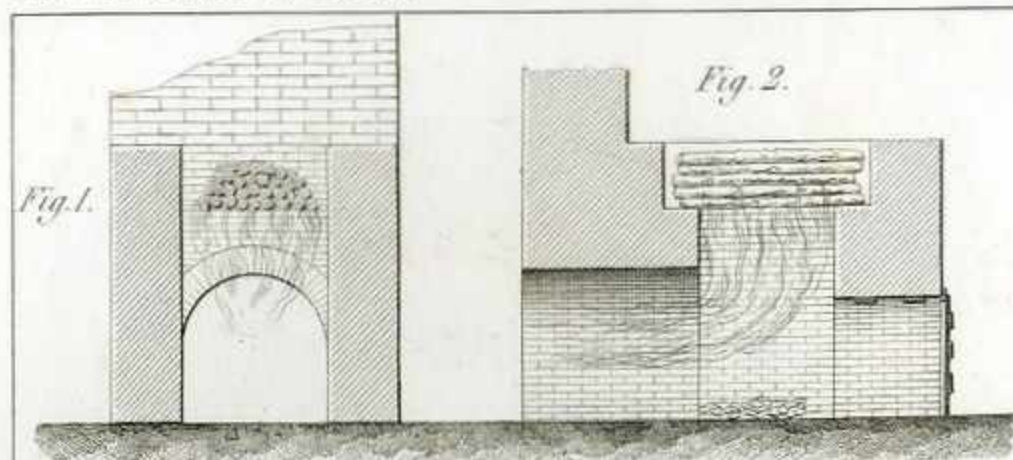


Echelle des Fig. 1, 2 et 3.
0 1 2 3 4 5 6 7 8 9 10 décim. 5 mètres

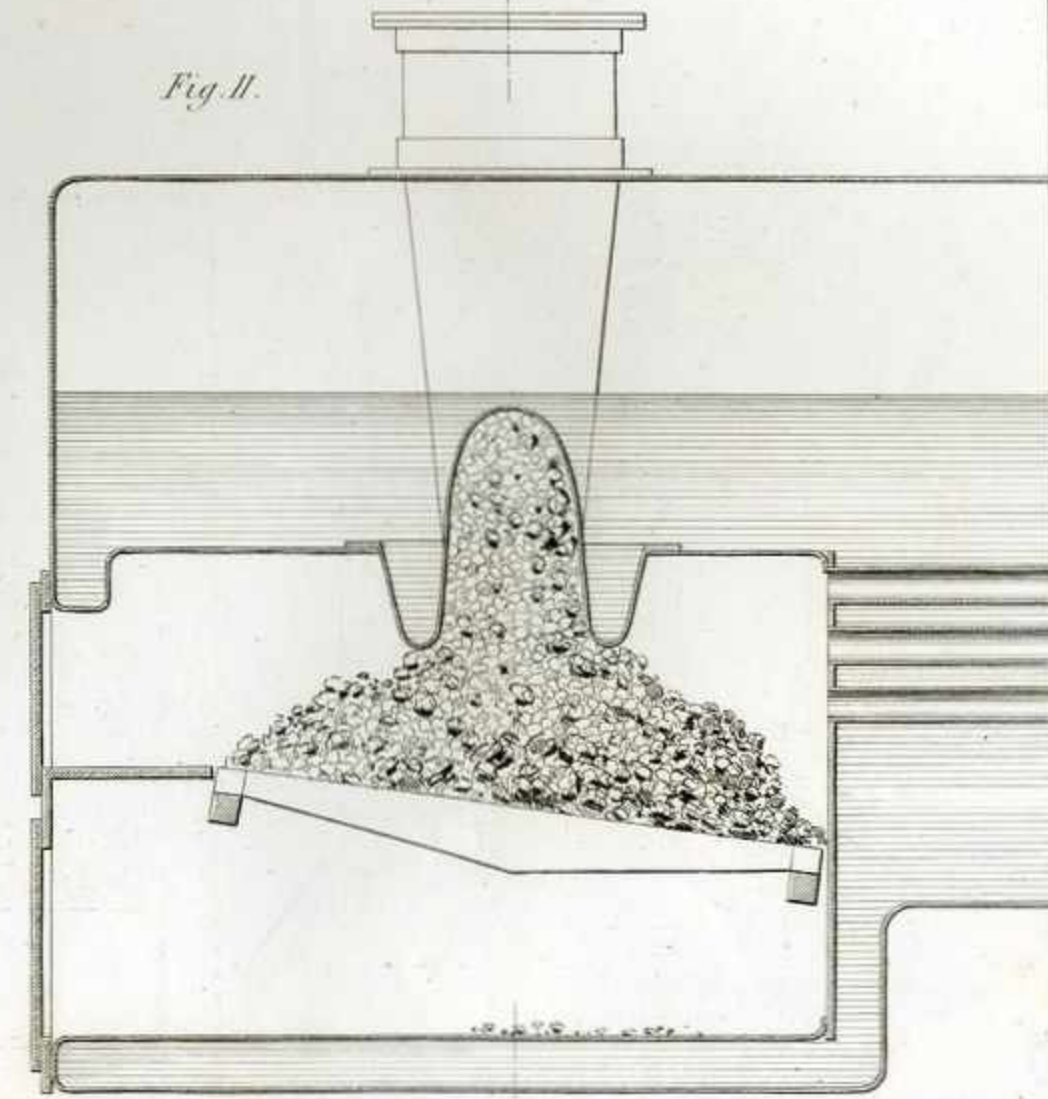
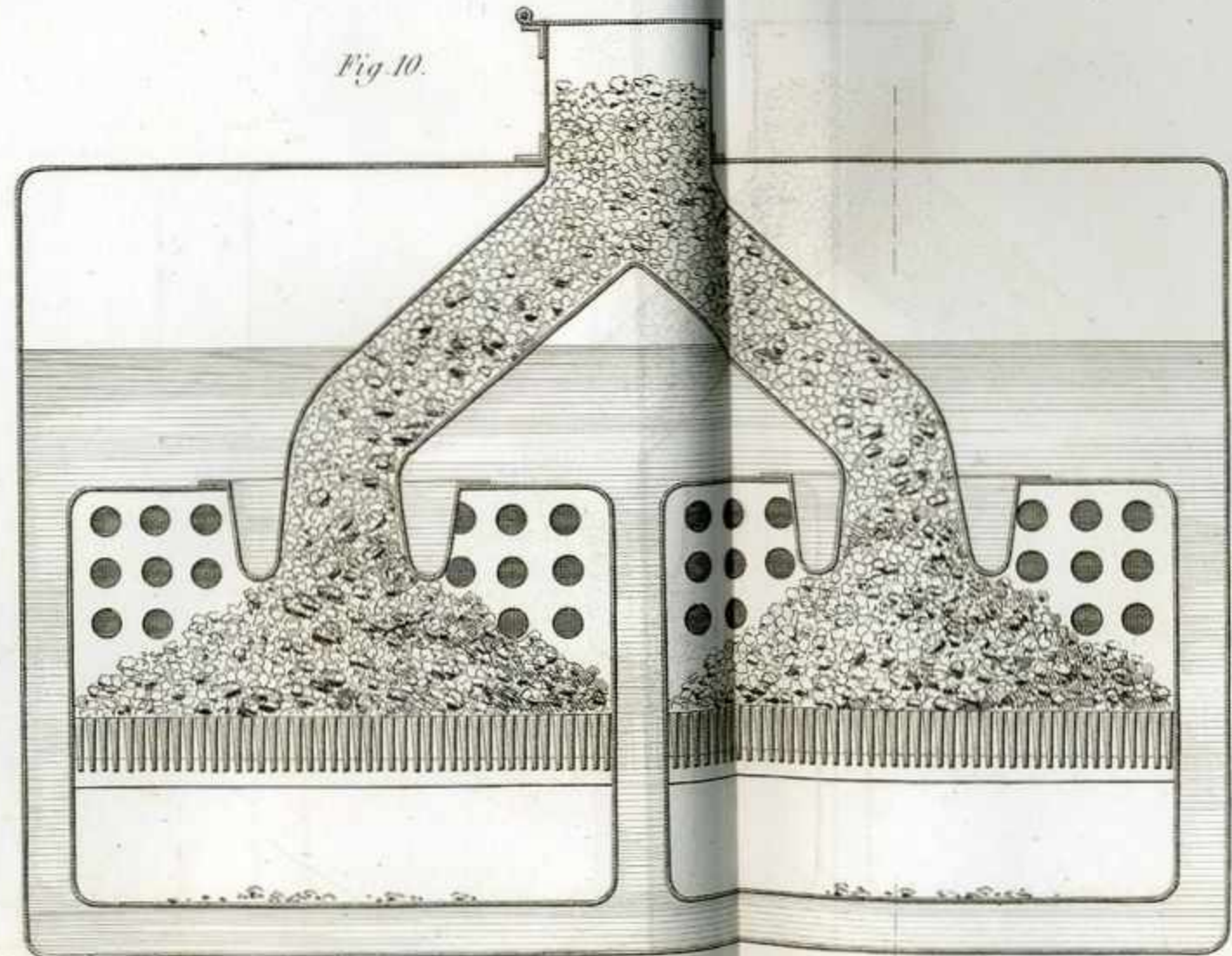
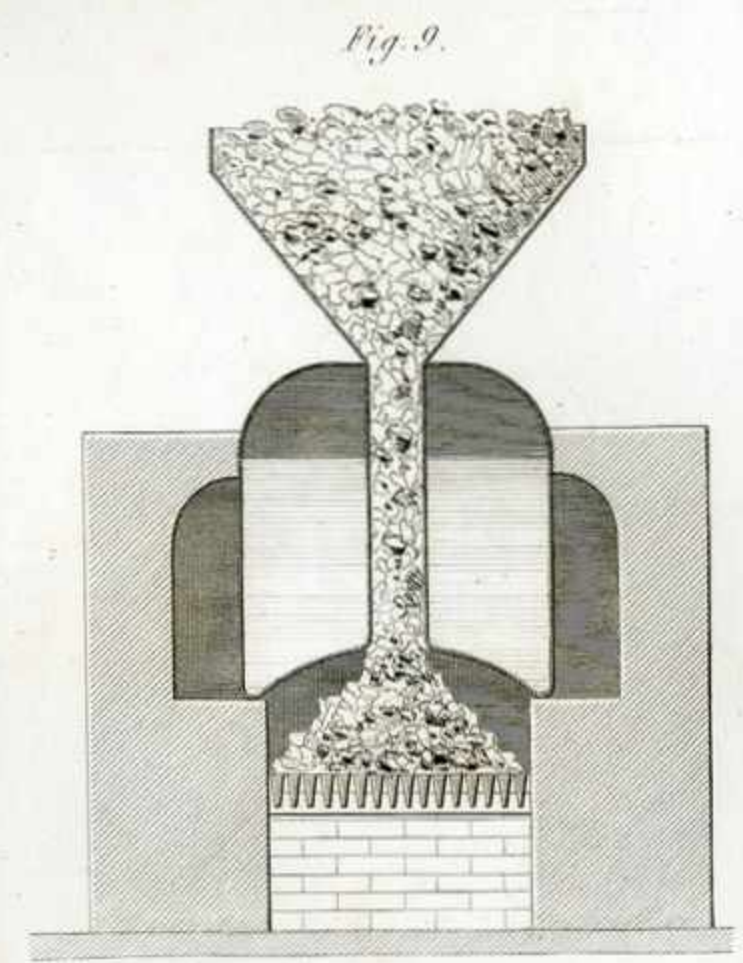


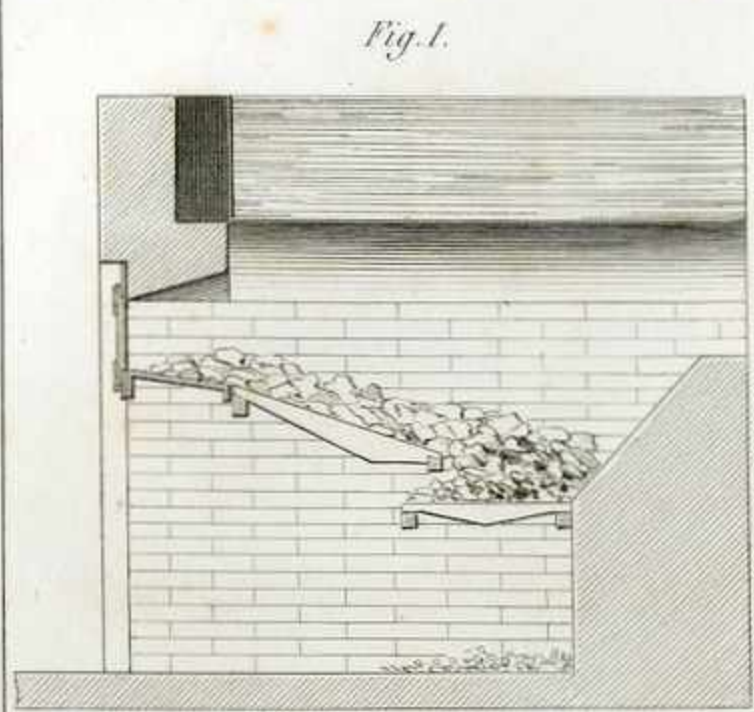
Echelle des Fig. 6, 7, 8, 9, 10 et 12.
0 1 2 3 4 5 mètres



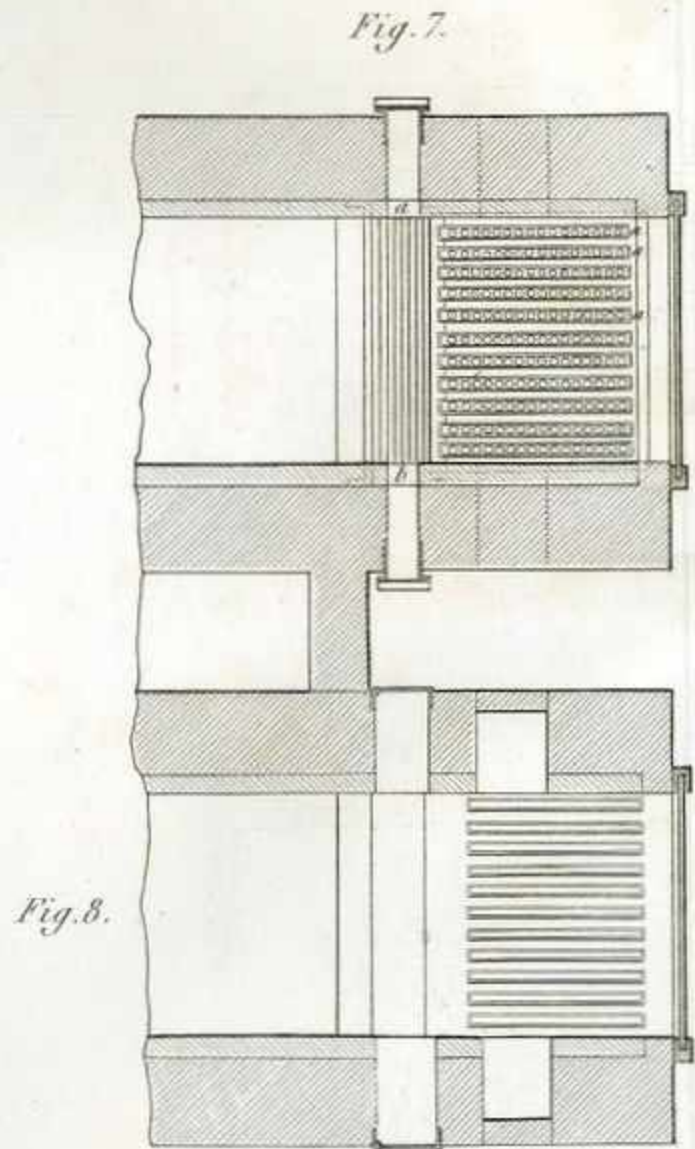
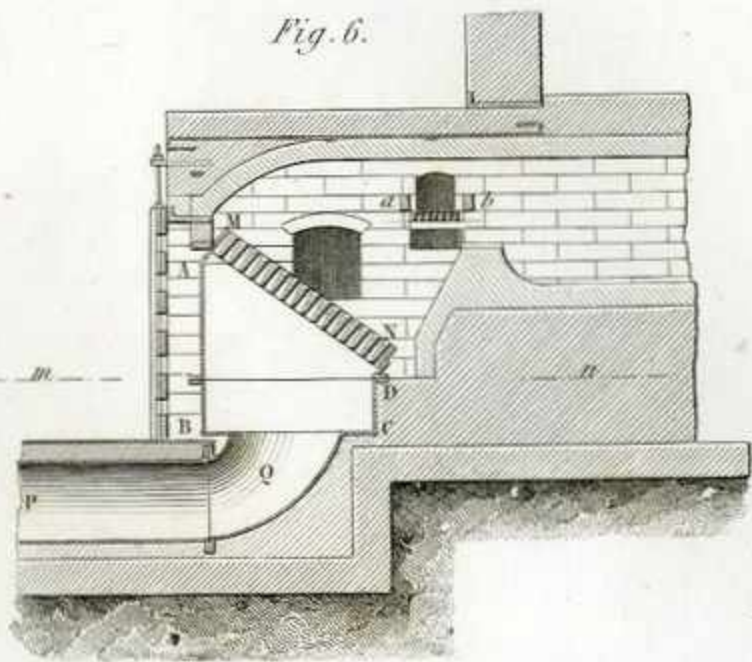
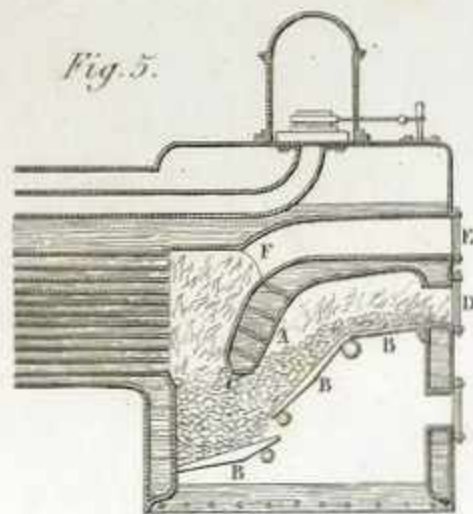
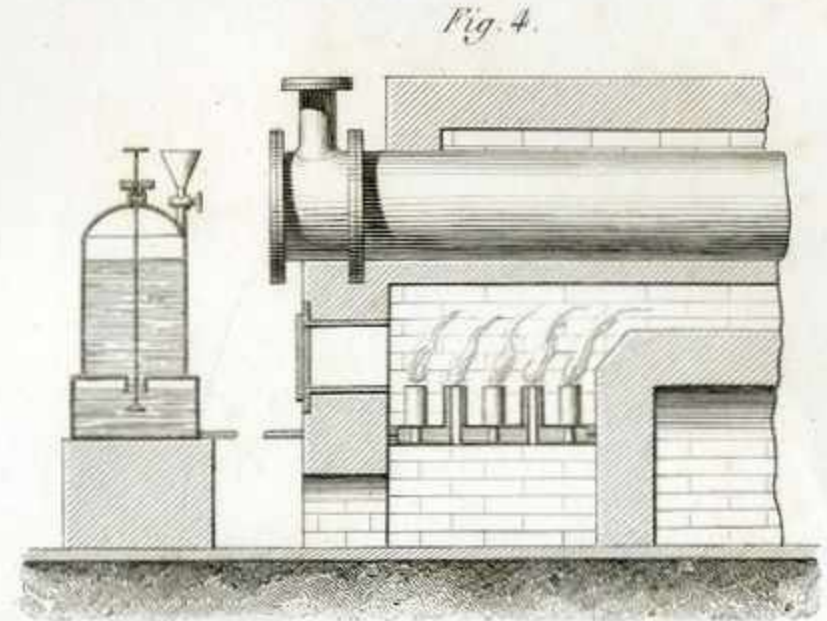
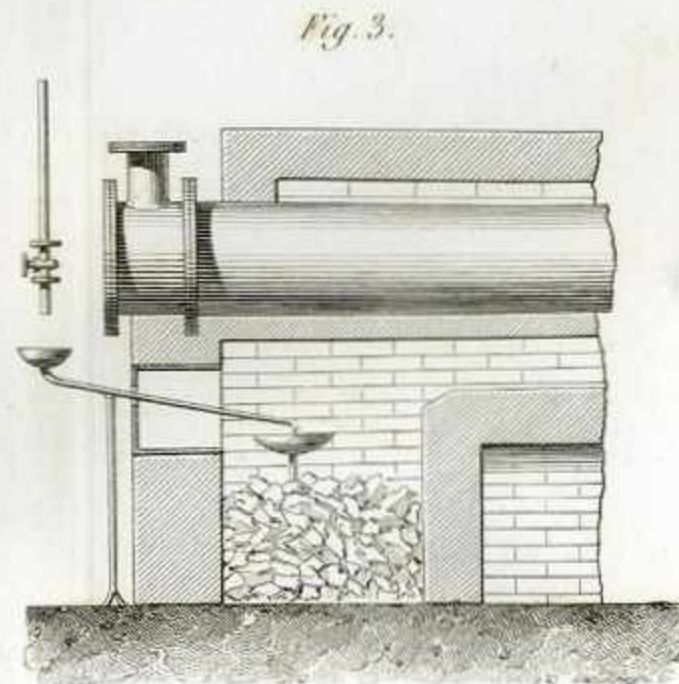
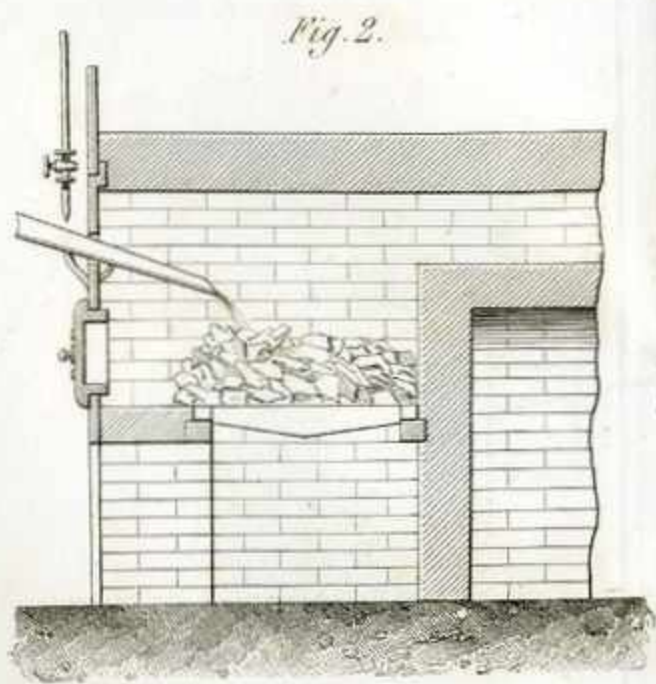


Echelle des Fig. 10 et 11. 2 mètres

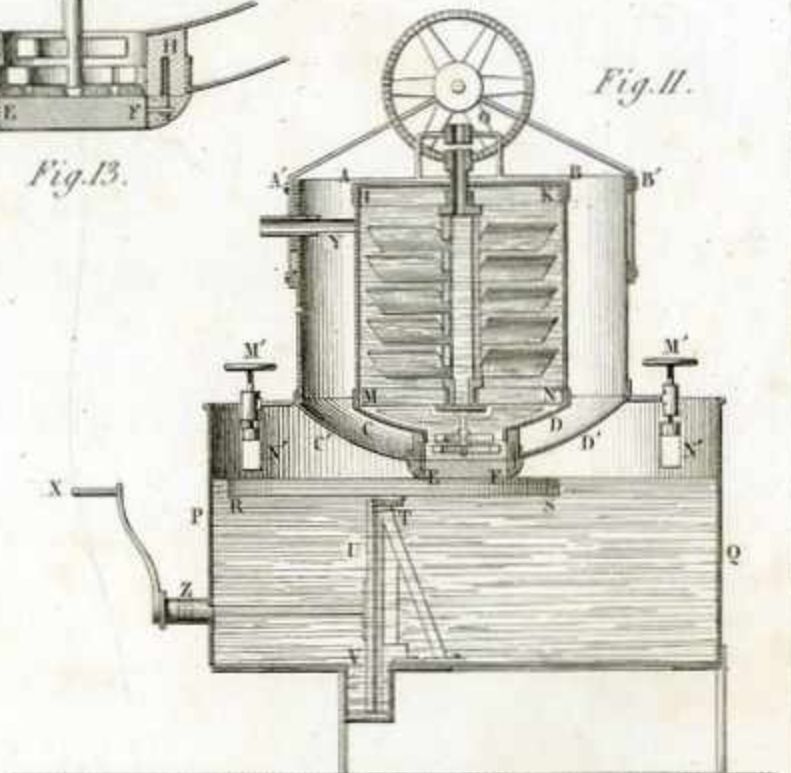
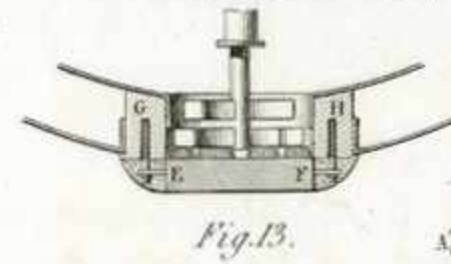
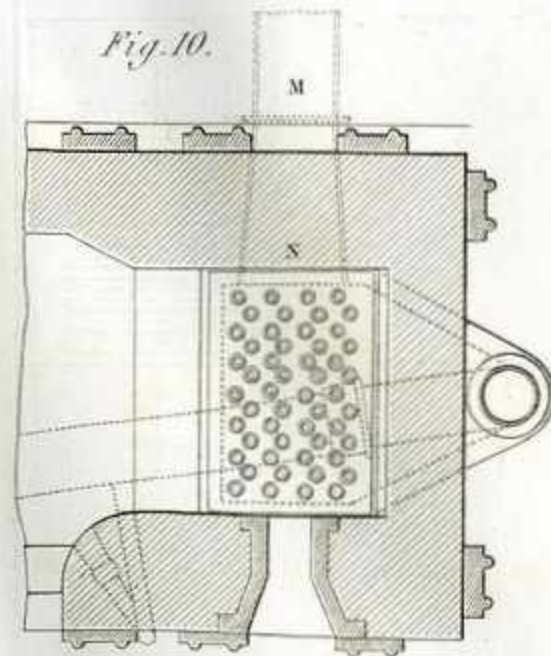
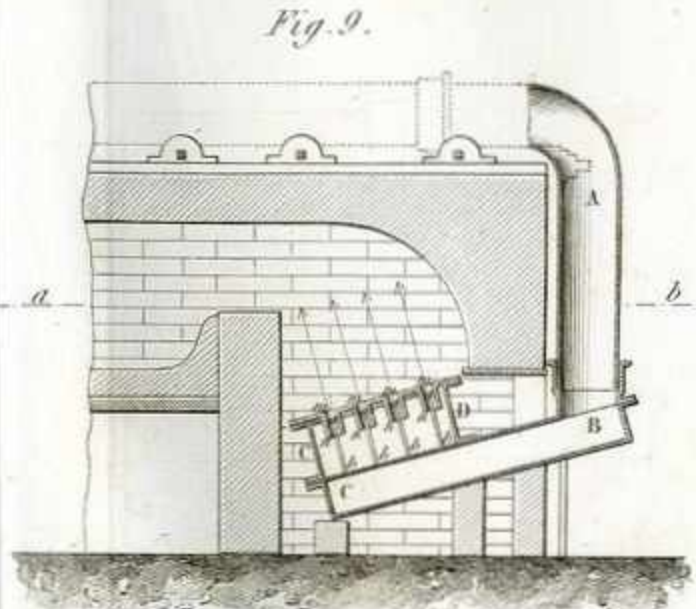




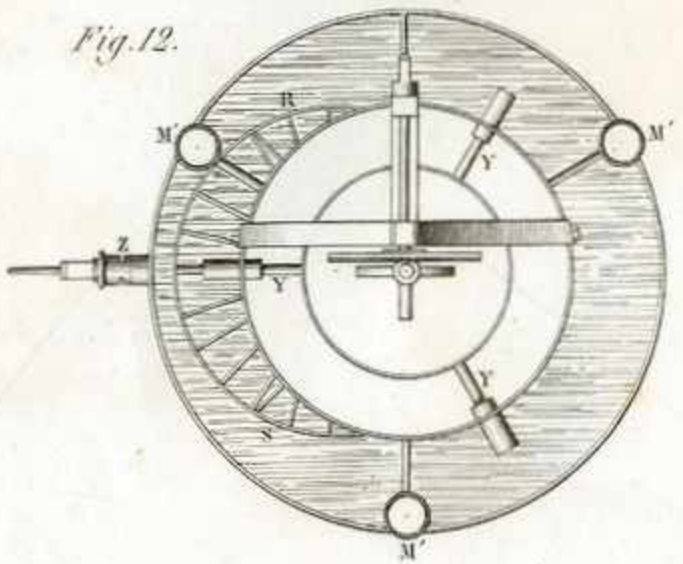
Echelle de la Fig. 1.
0 1 2 3 4 5 décim. 1 mètre.

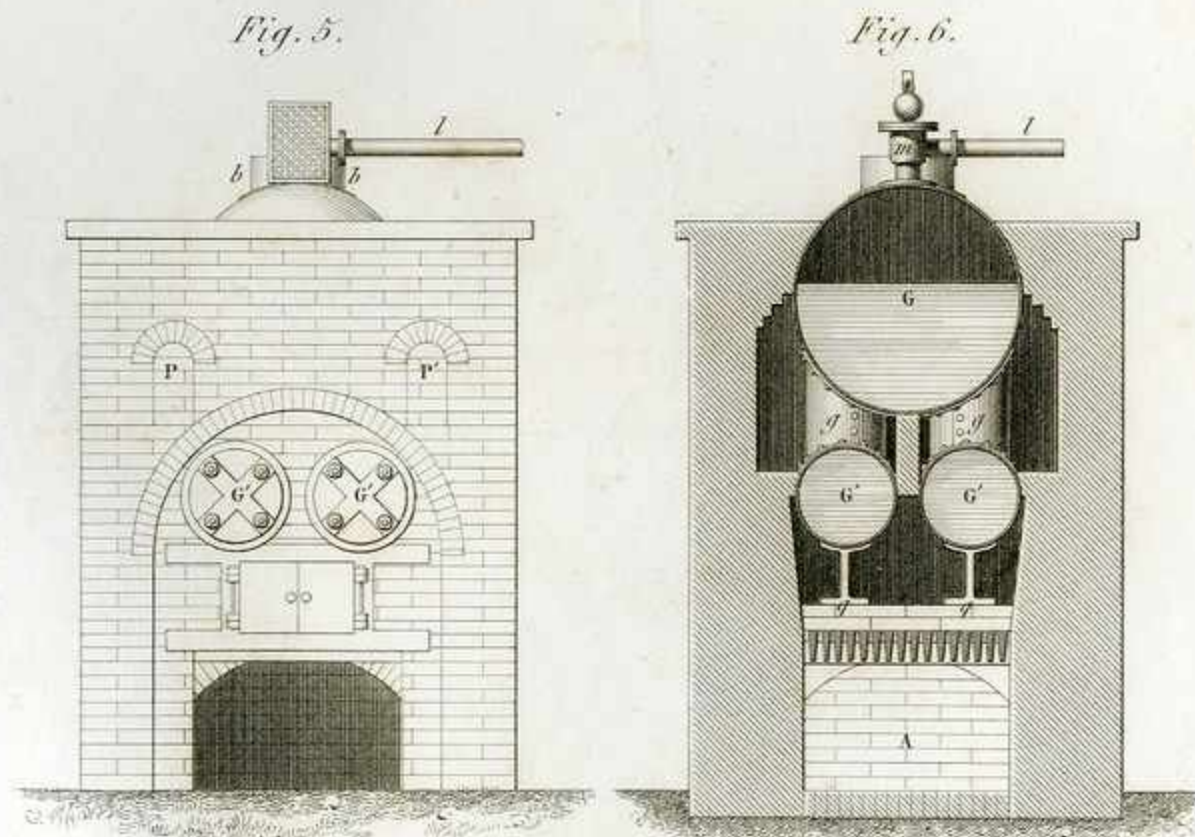
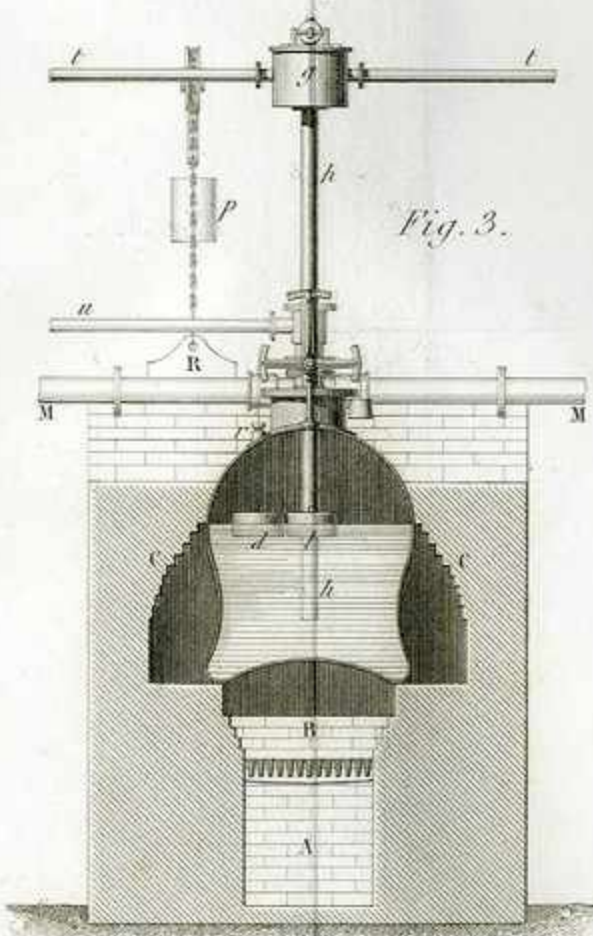
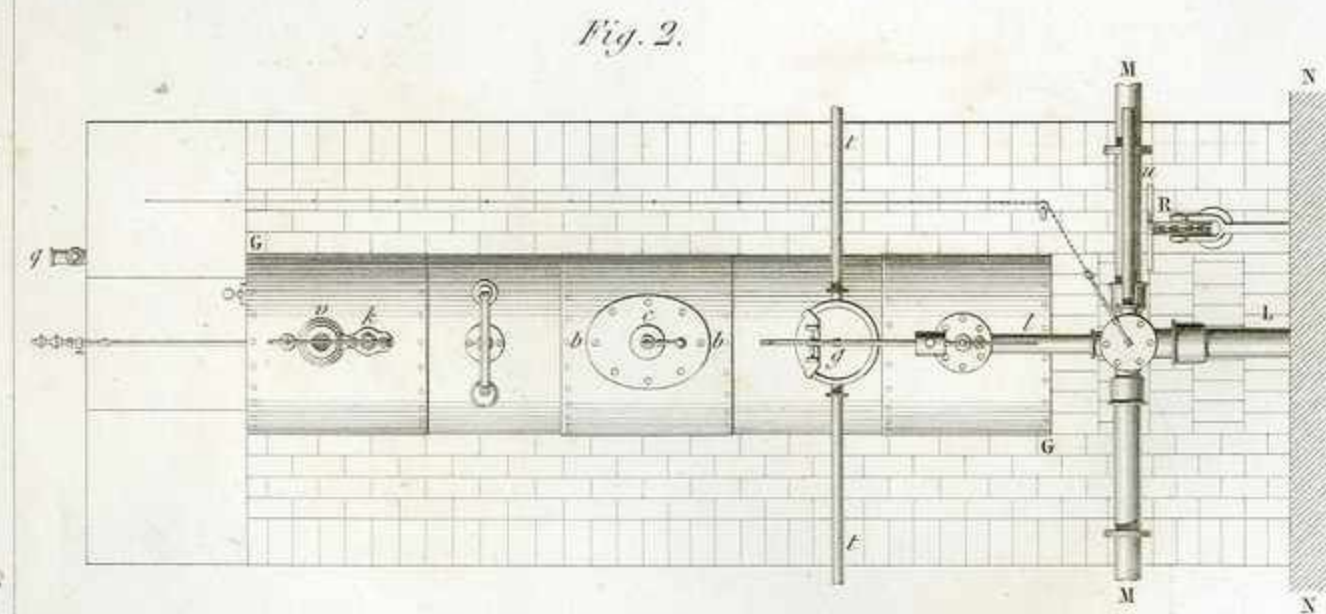
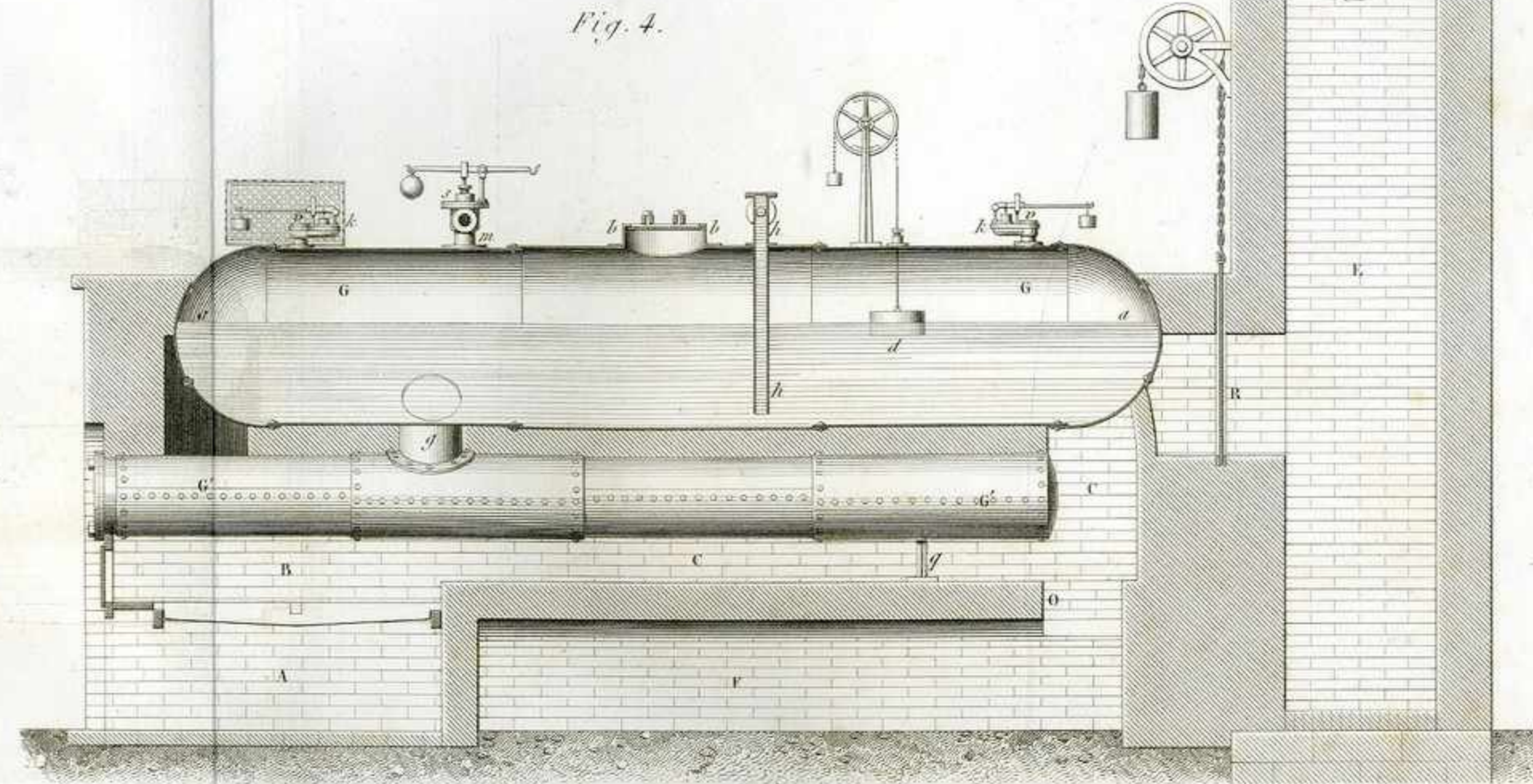
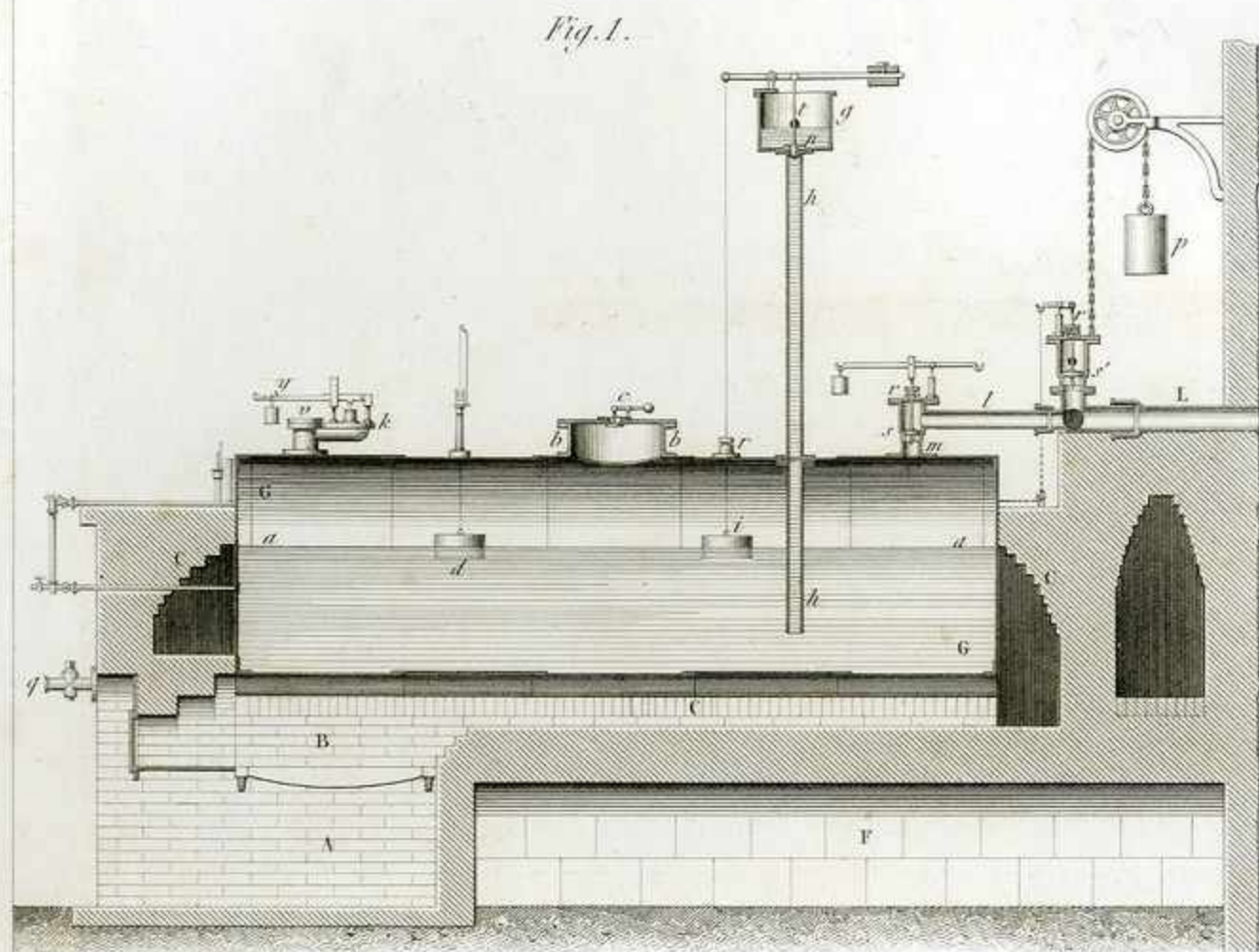


Echelle des Fig. 6, 7, 8, 9 et 10.
0 1 2 3 4 5 6 7 8 9 10 décim. 1 mètre.



Echelle des Fig. 11 et 12.
0 1 2 3 4 5 6 7 8 9 10 décim.



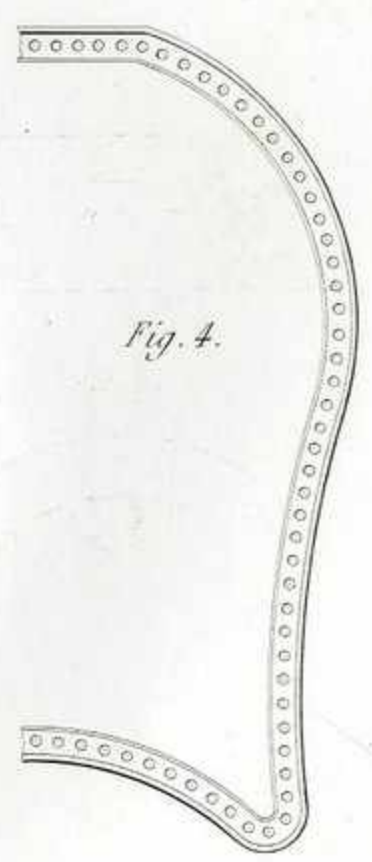
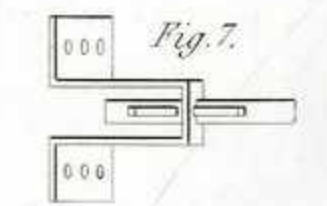
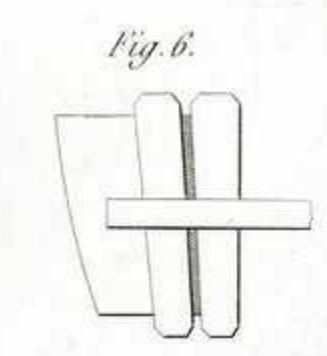
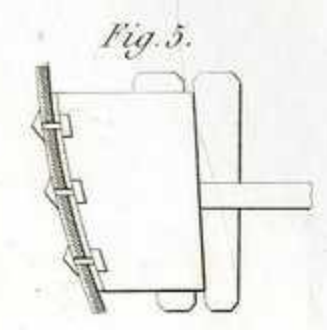
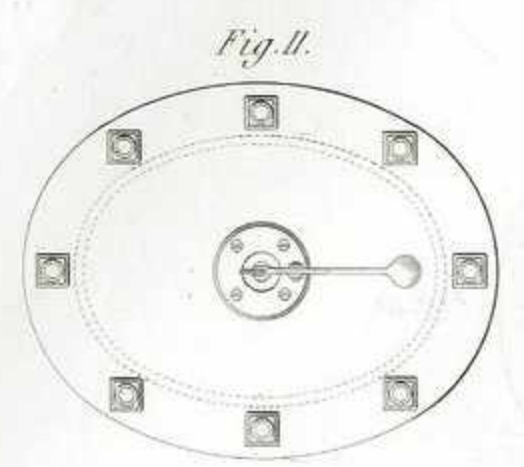
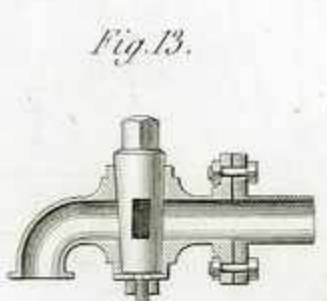
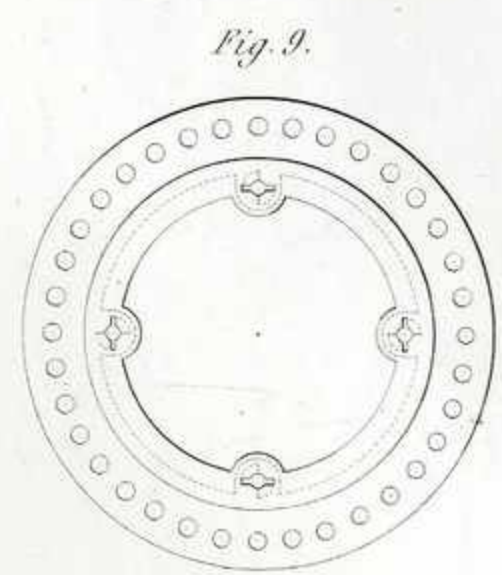
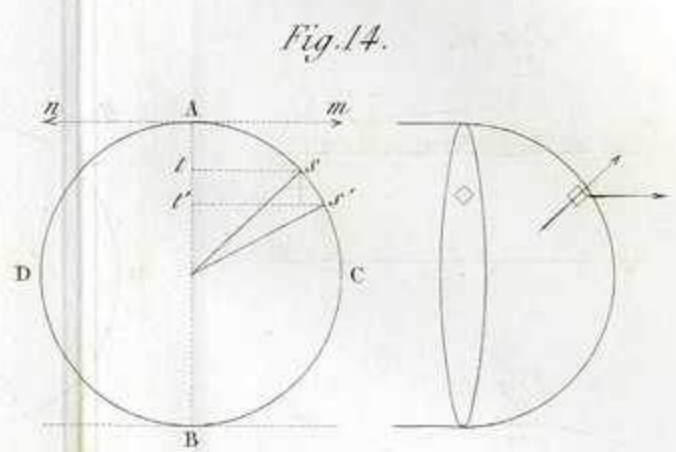
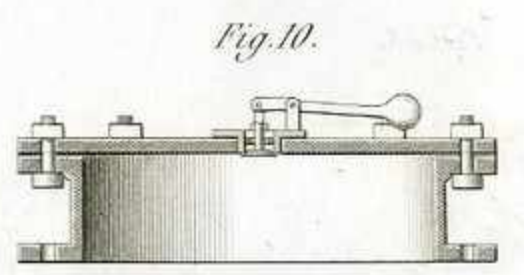
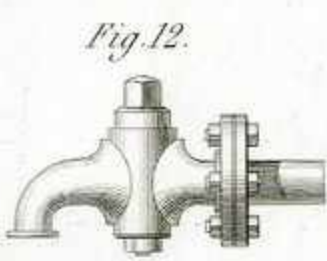
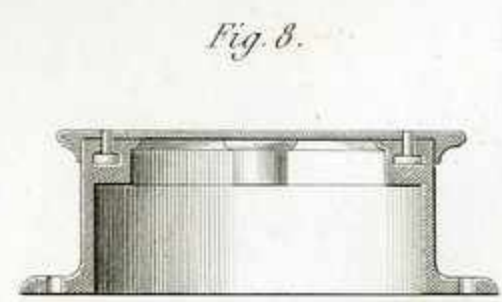
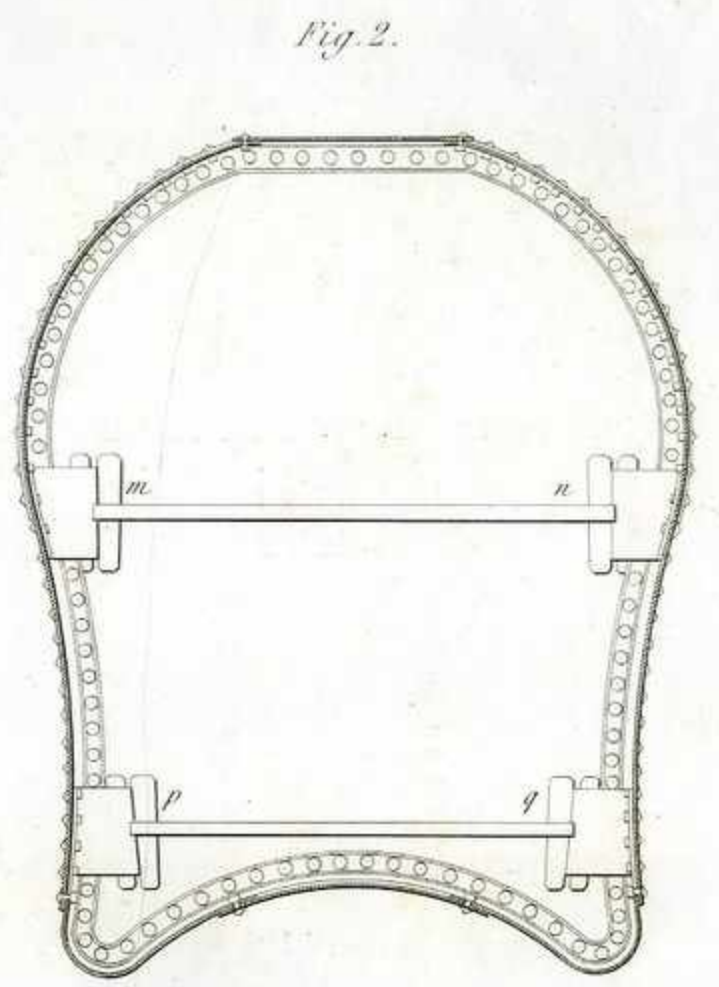
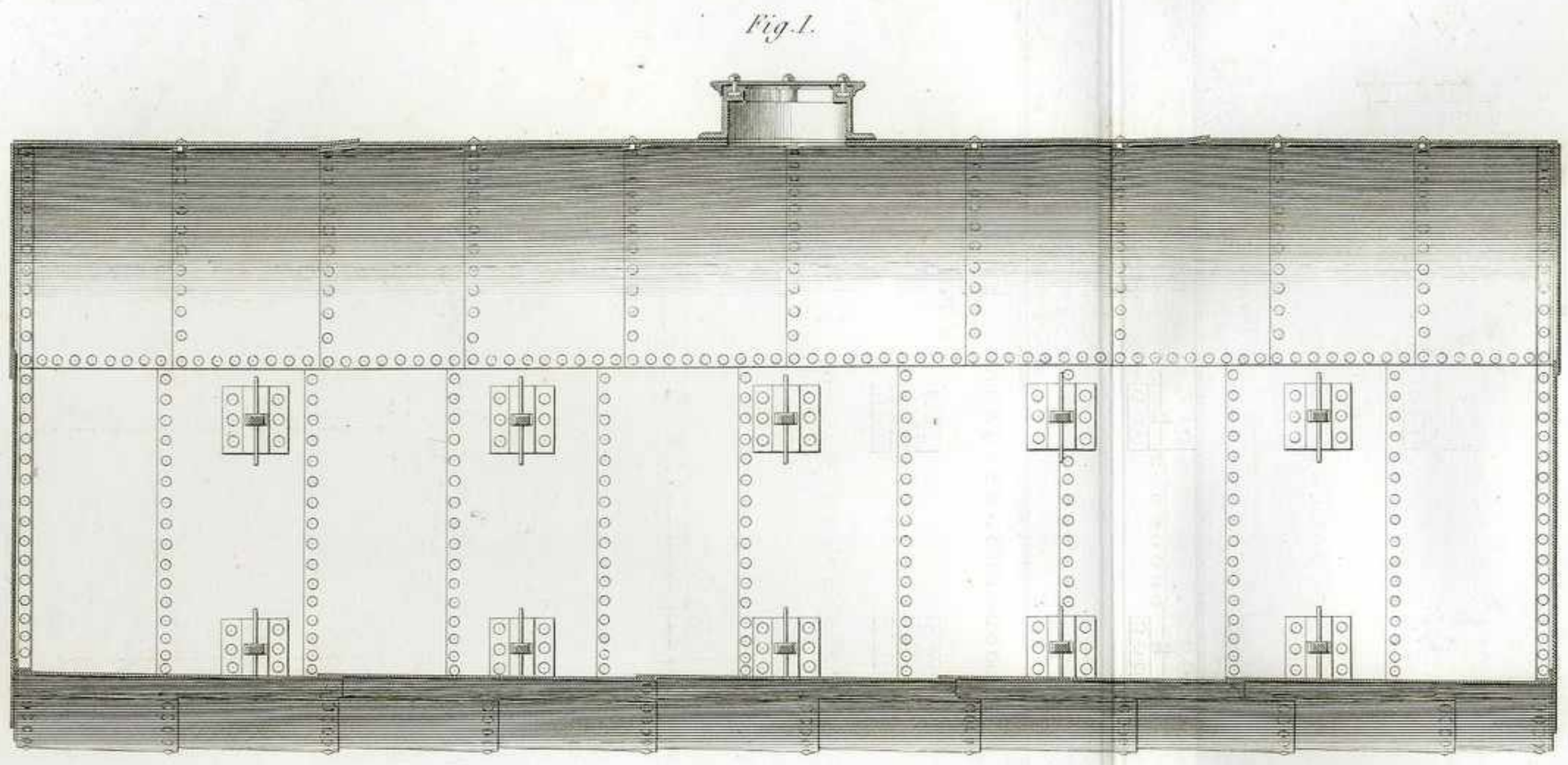


Echelle des Fig. 1, 2 et 3.



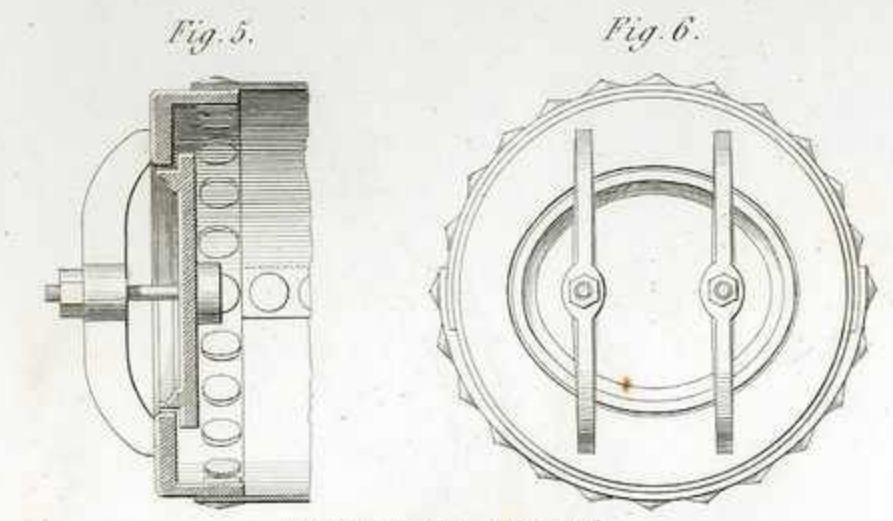
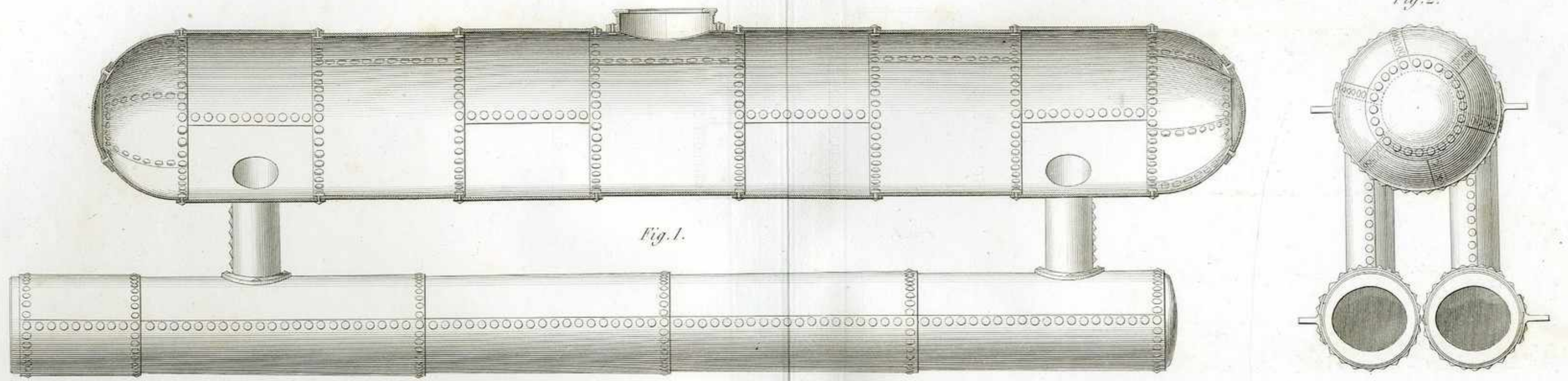
Echelle des Fig. 4, 5 et 6.



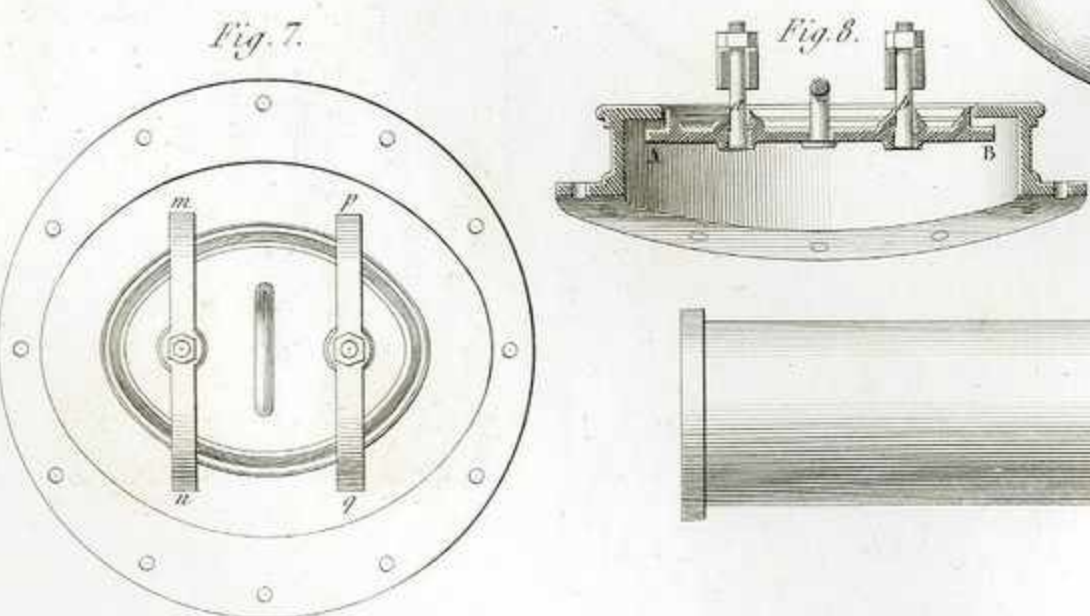


Echelle des Fig. 1, 2, 3 et 4.
2 mètres.

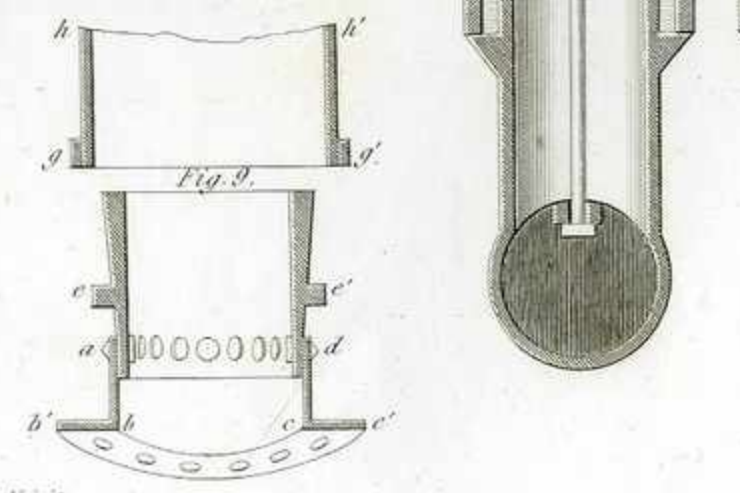
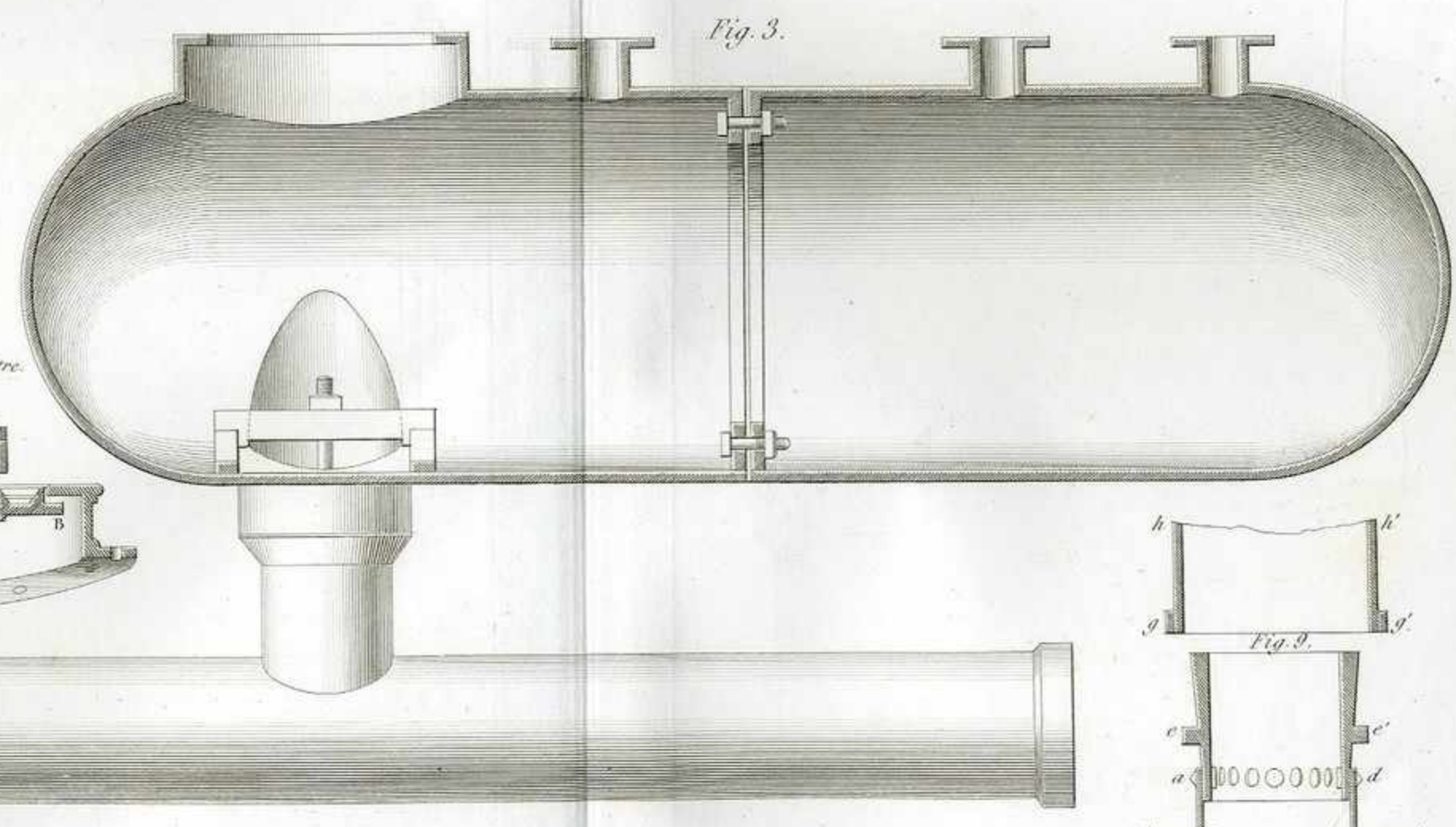
Echelle des Fig. 5, 6, 7 et 13.
1 mètre.



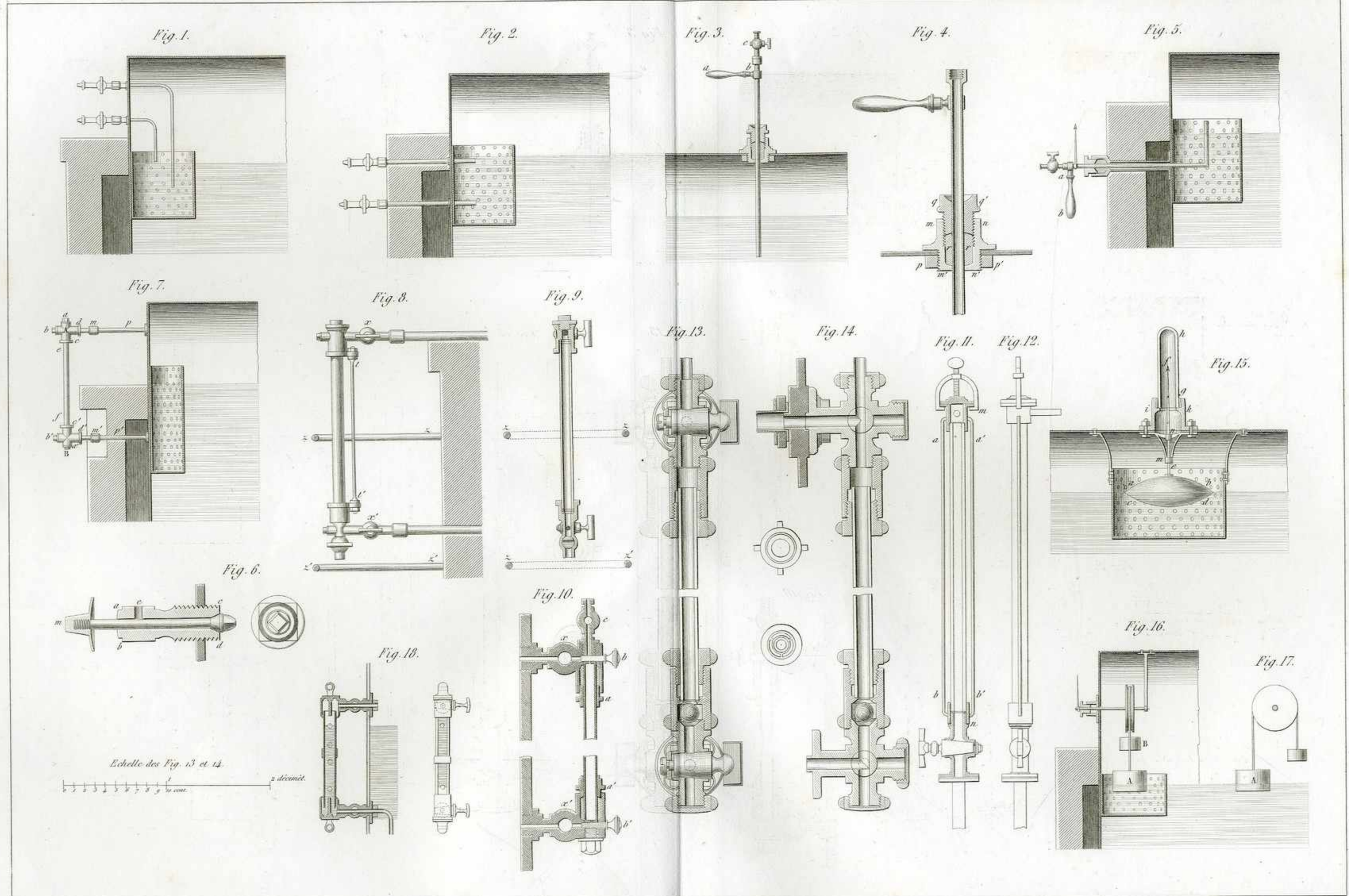
Echelle des Fig. 5, 6, 7 et 8. 1 mètre.

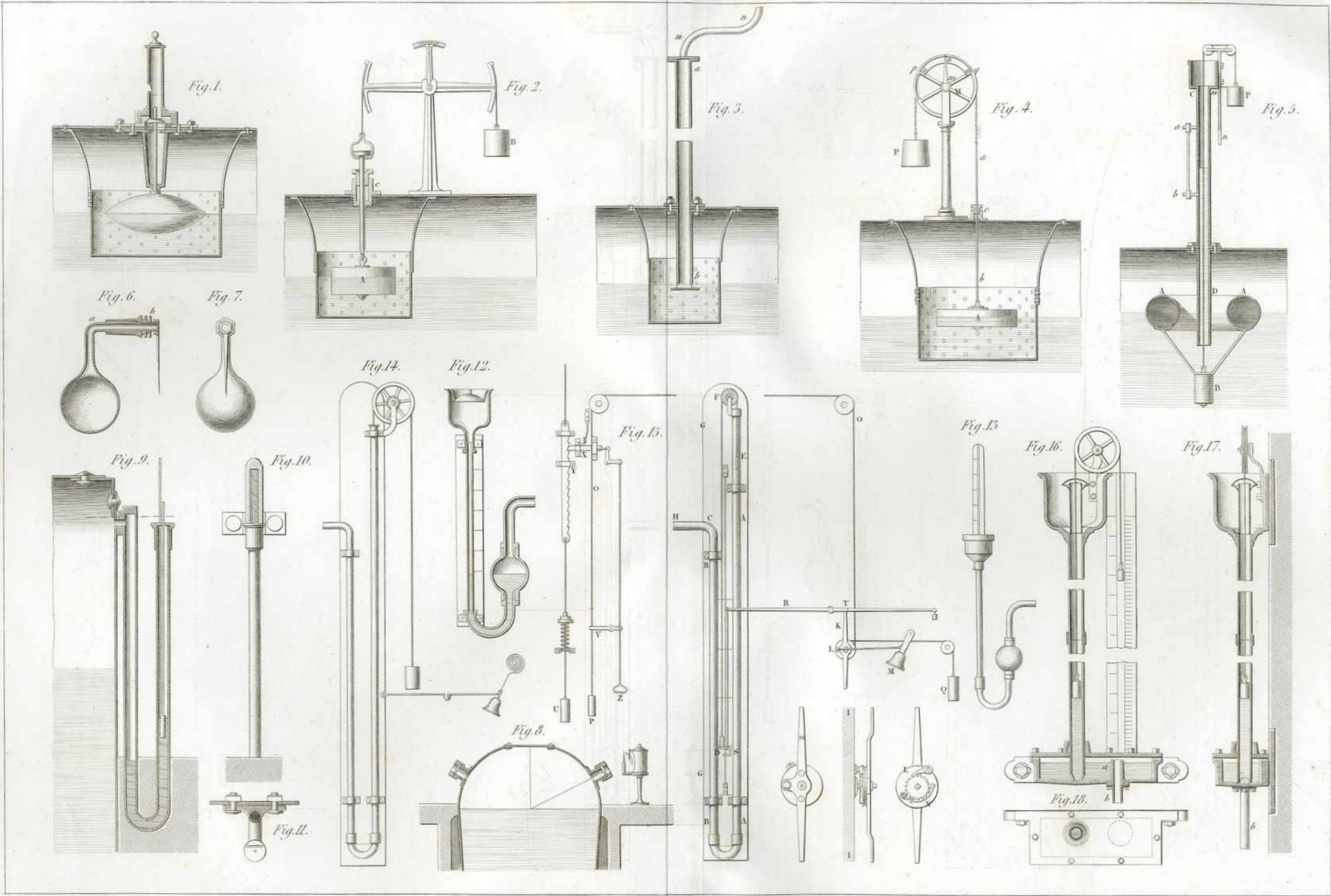


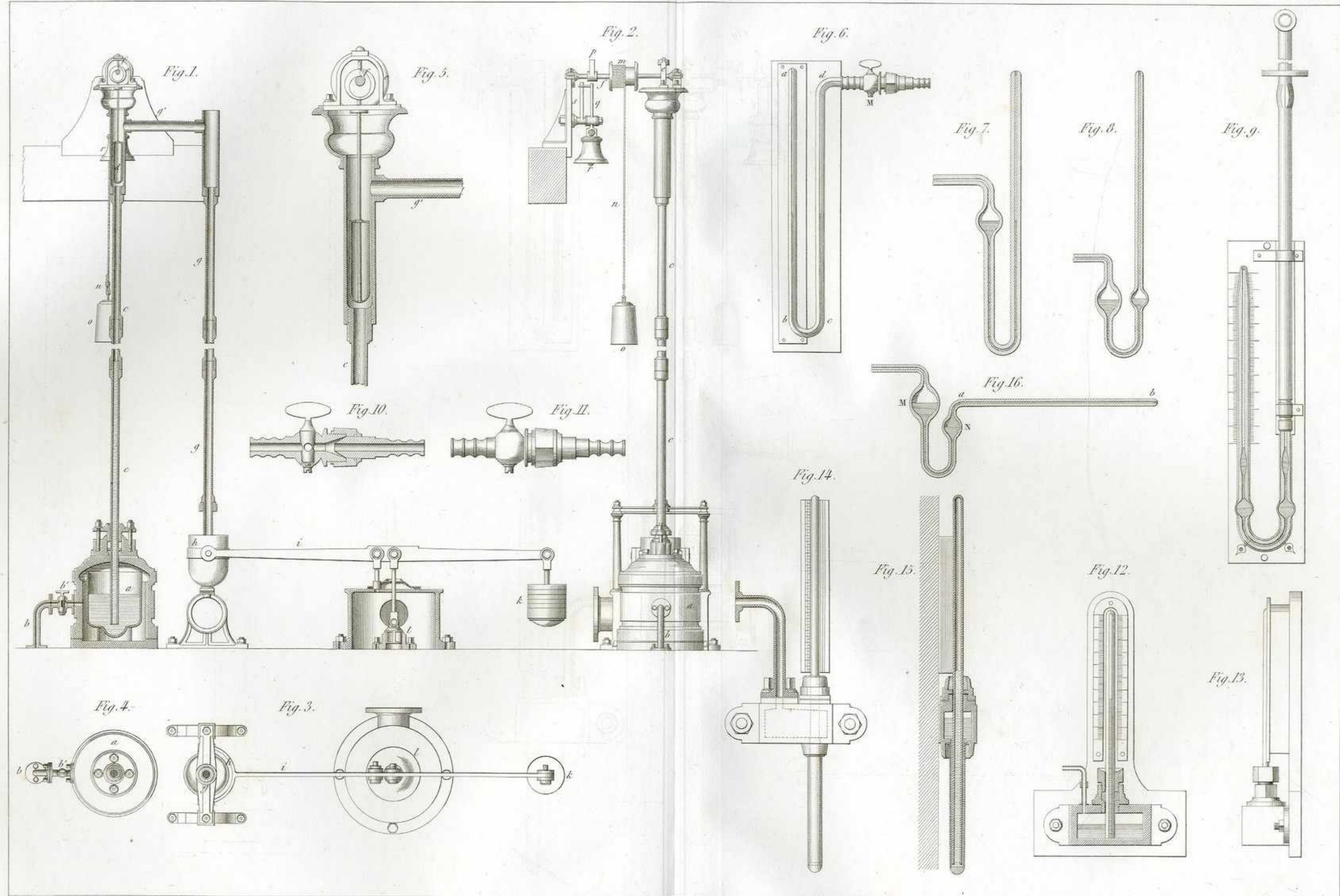
Echelle des Fig. 1 et 2. 2 mètres.

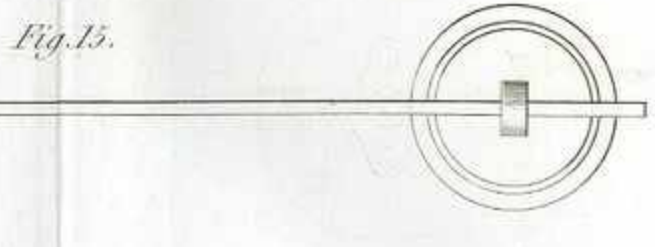
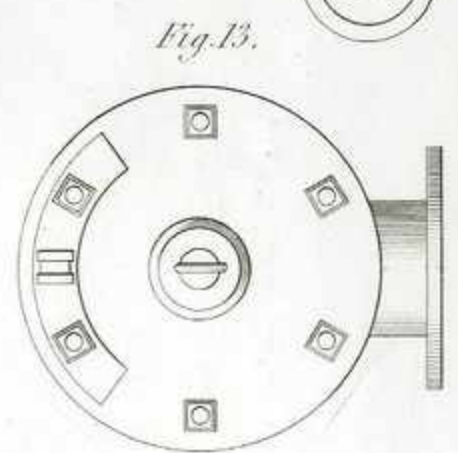
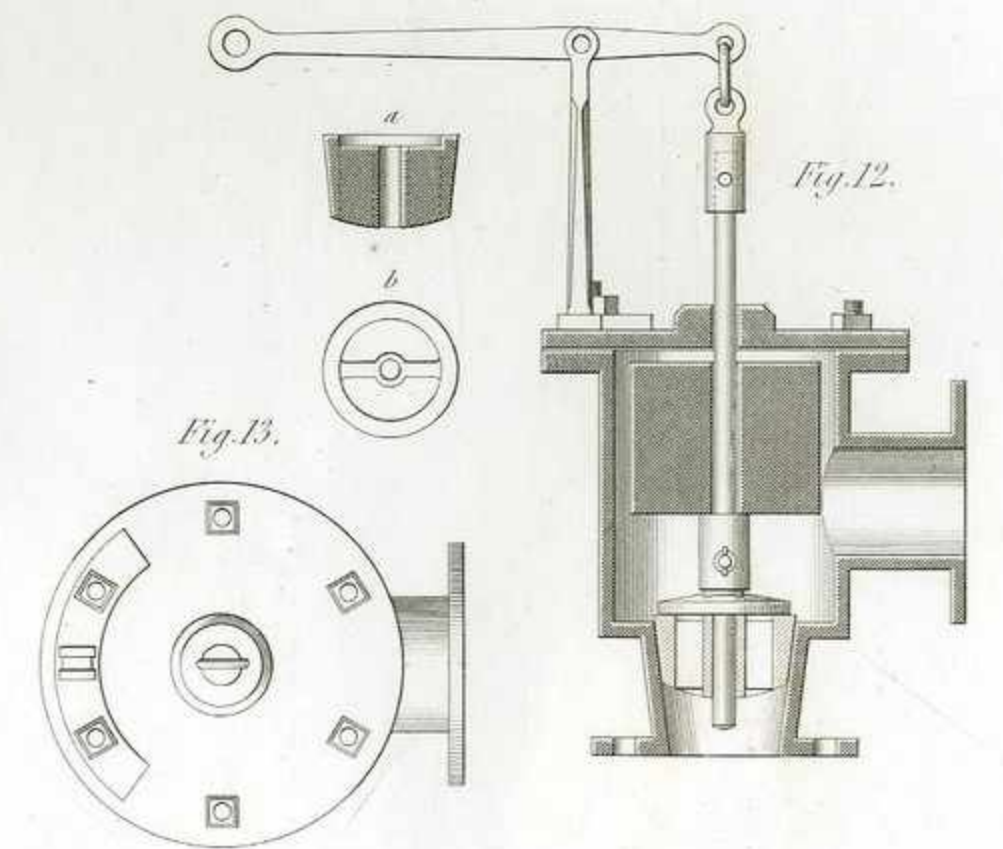
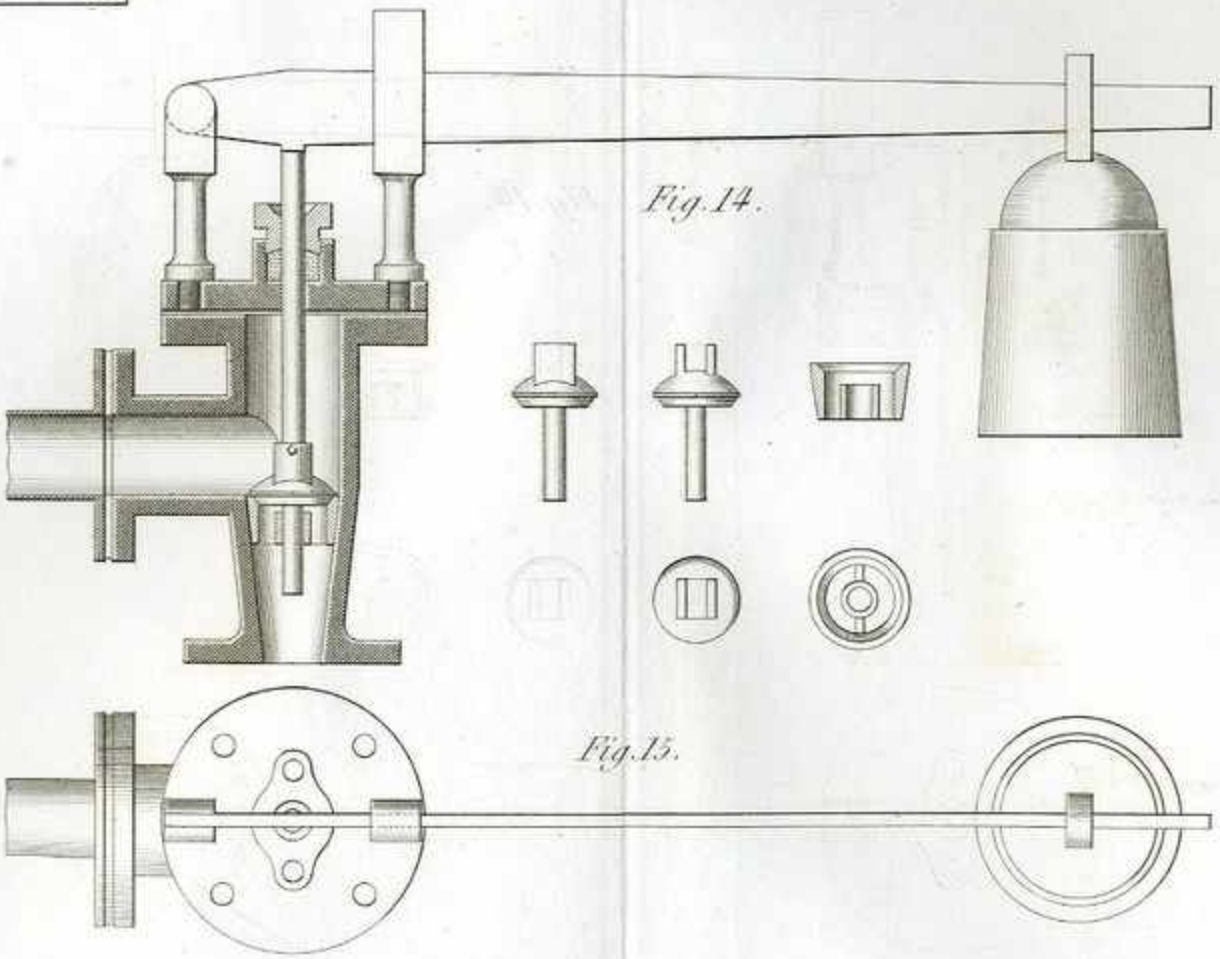
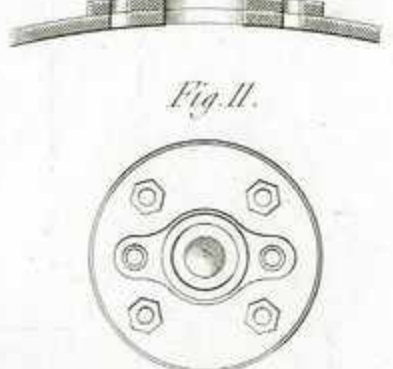
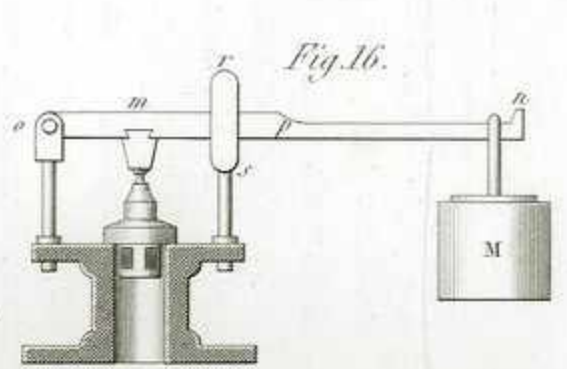
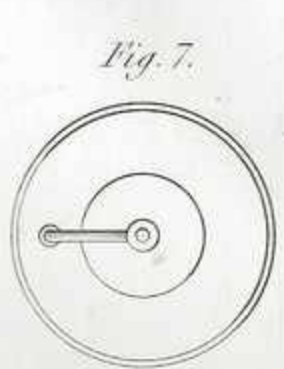
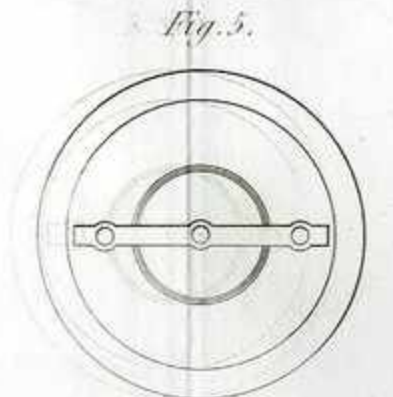
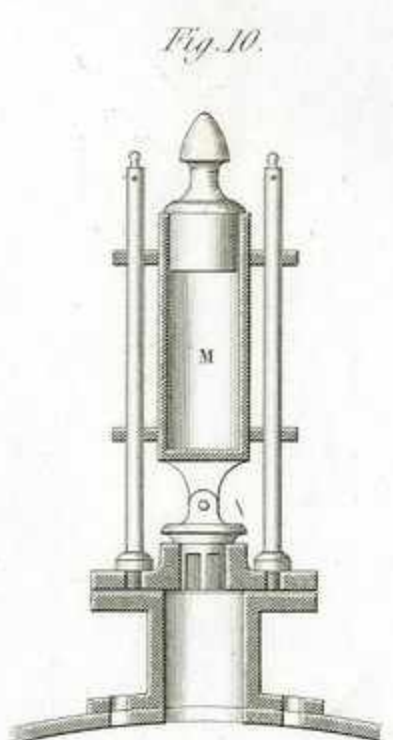
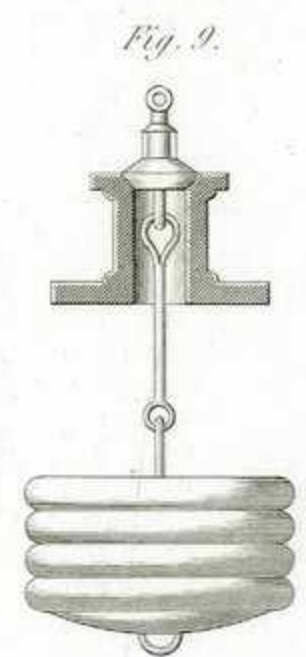
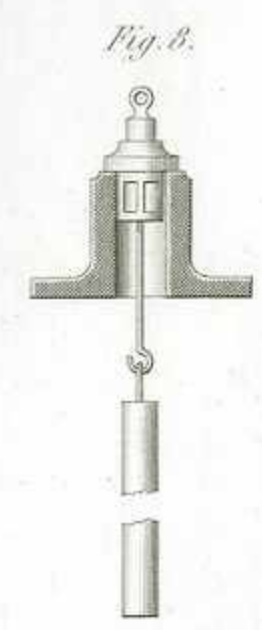
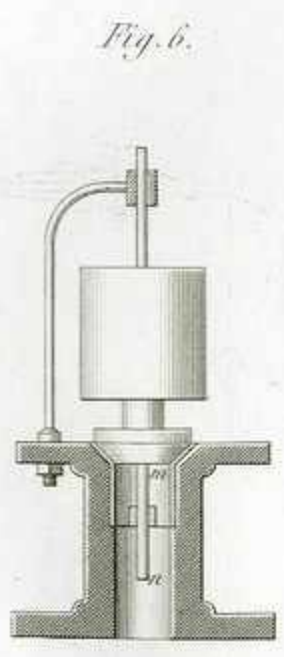
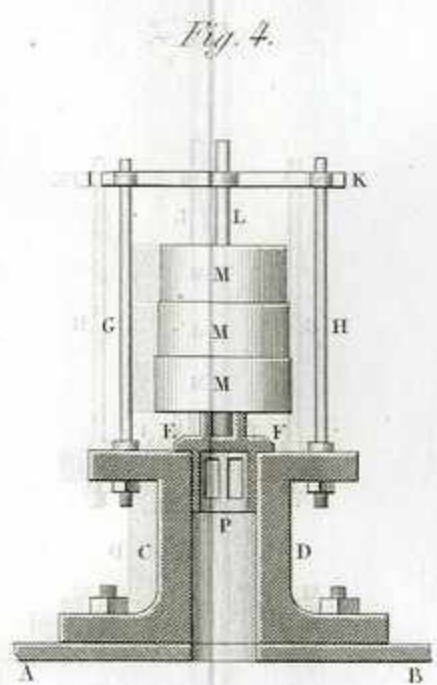
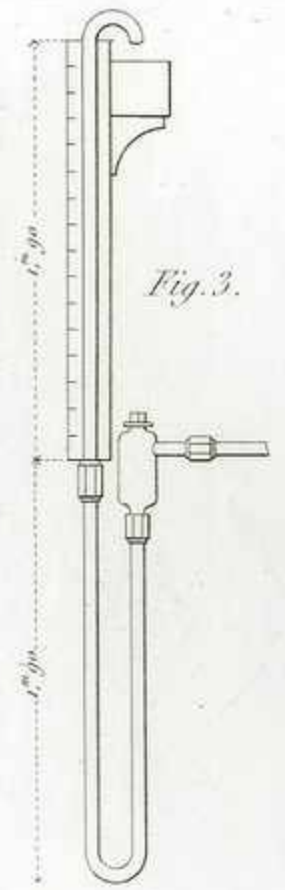
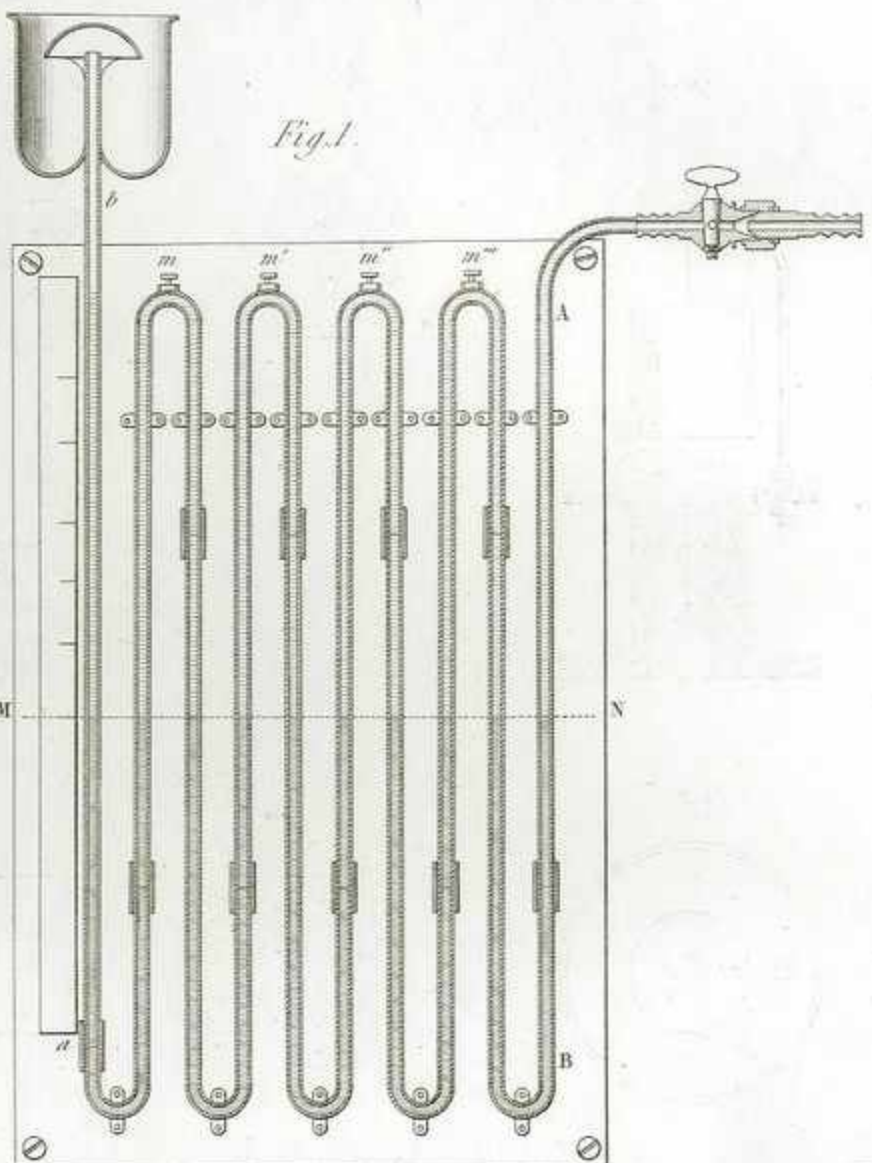
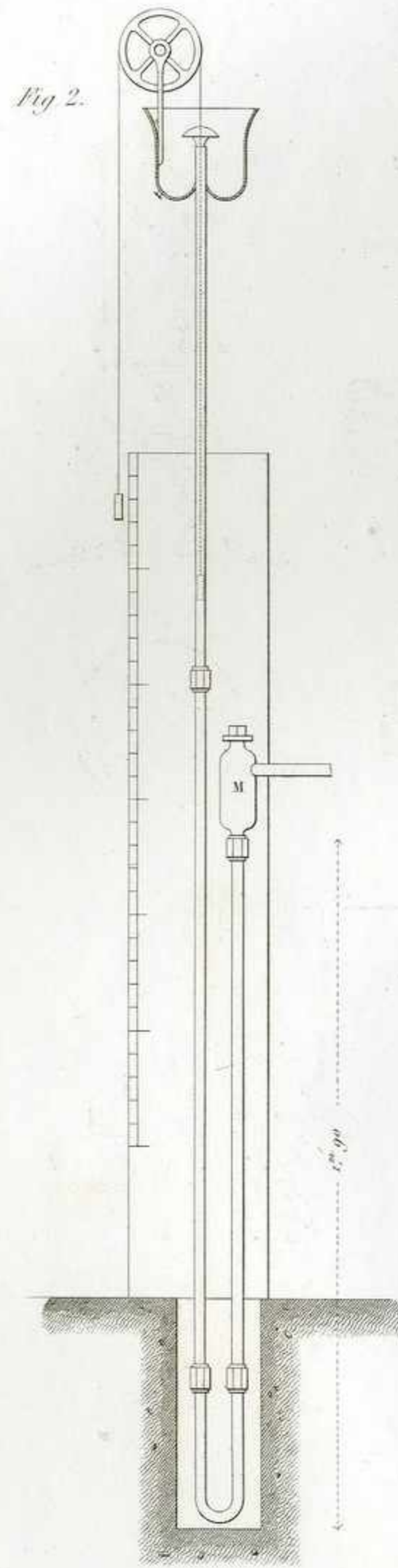


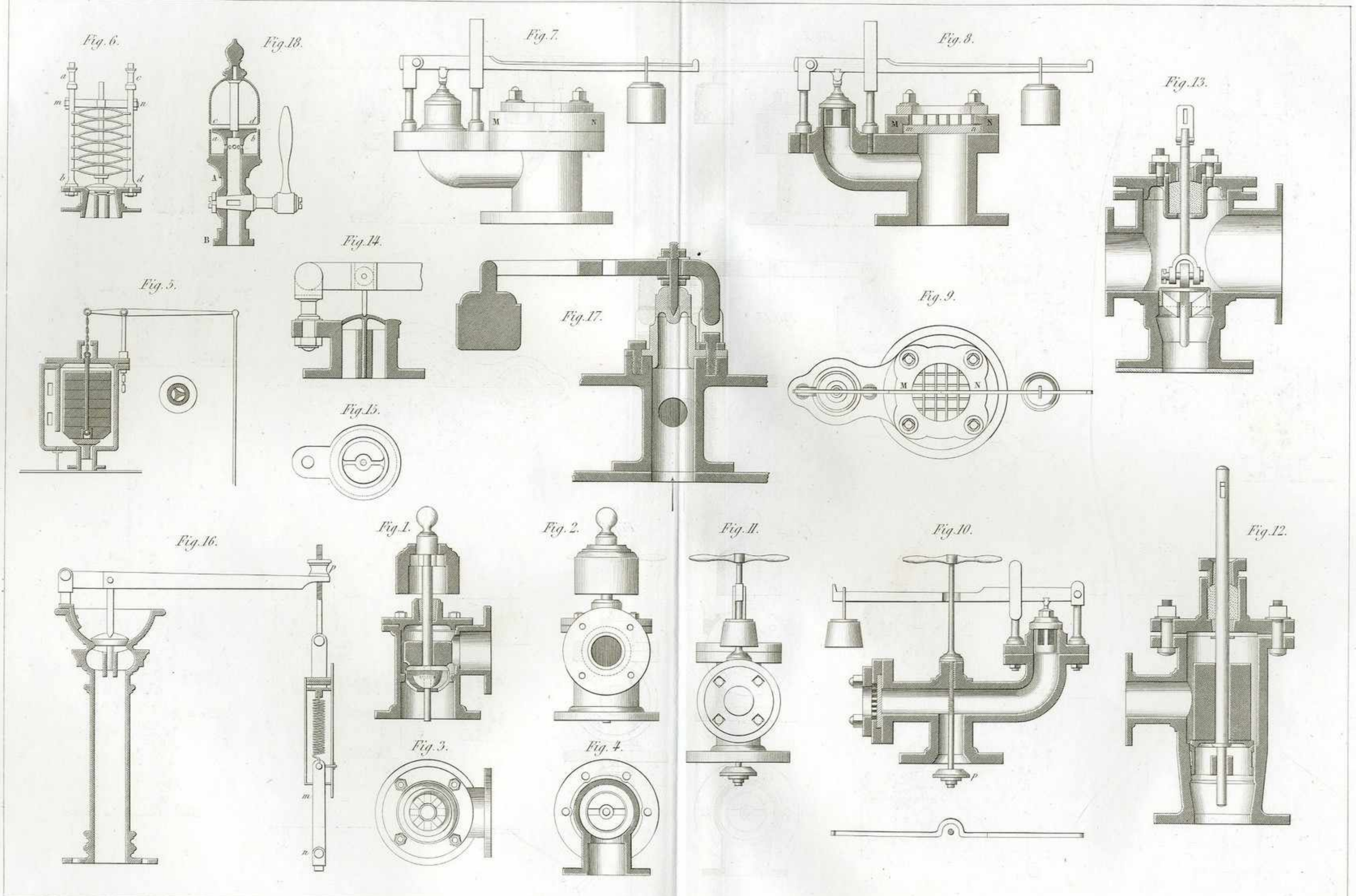
Echelle des Fig. 3 et 4. 2 mètres.

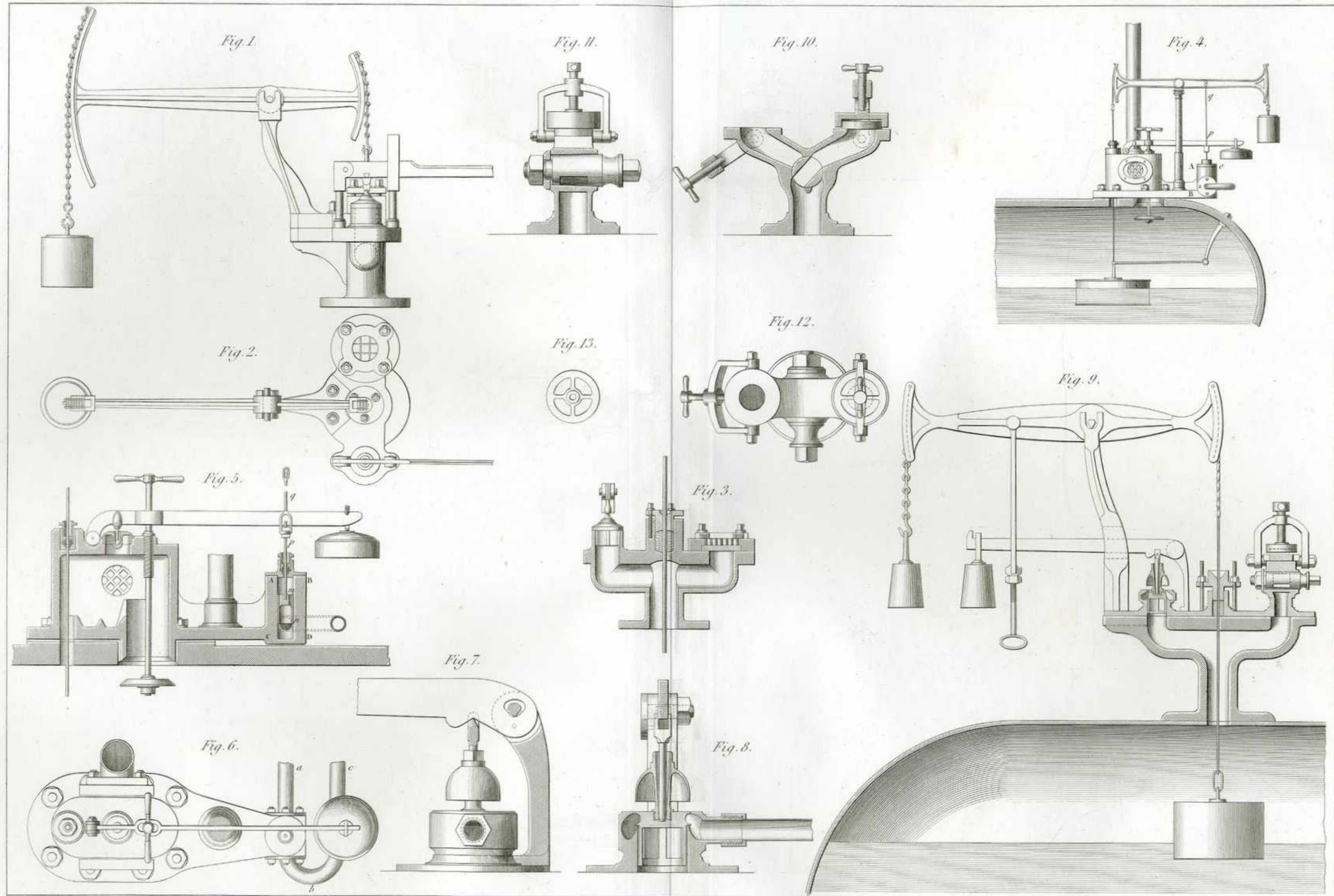


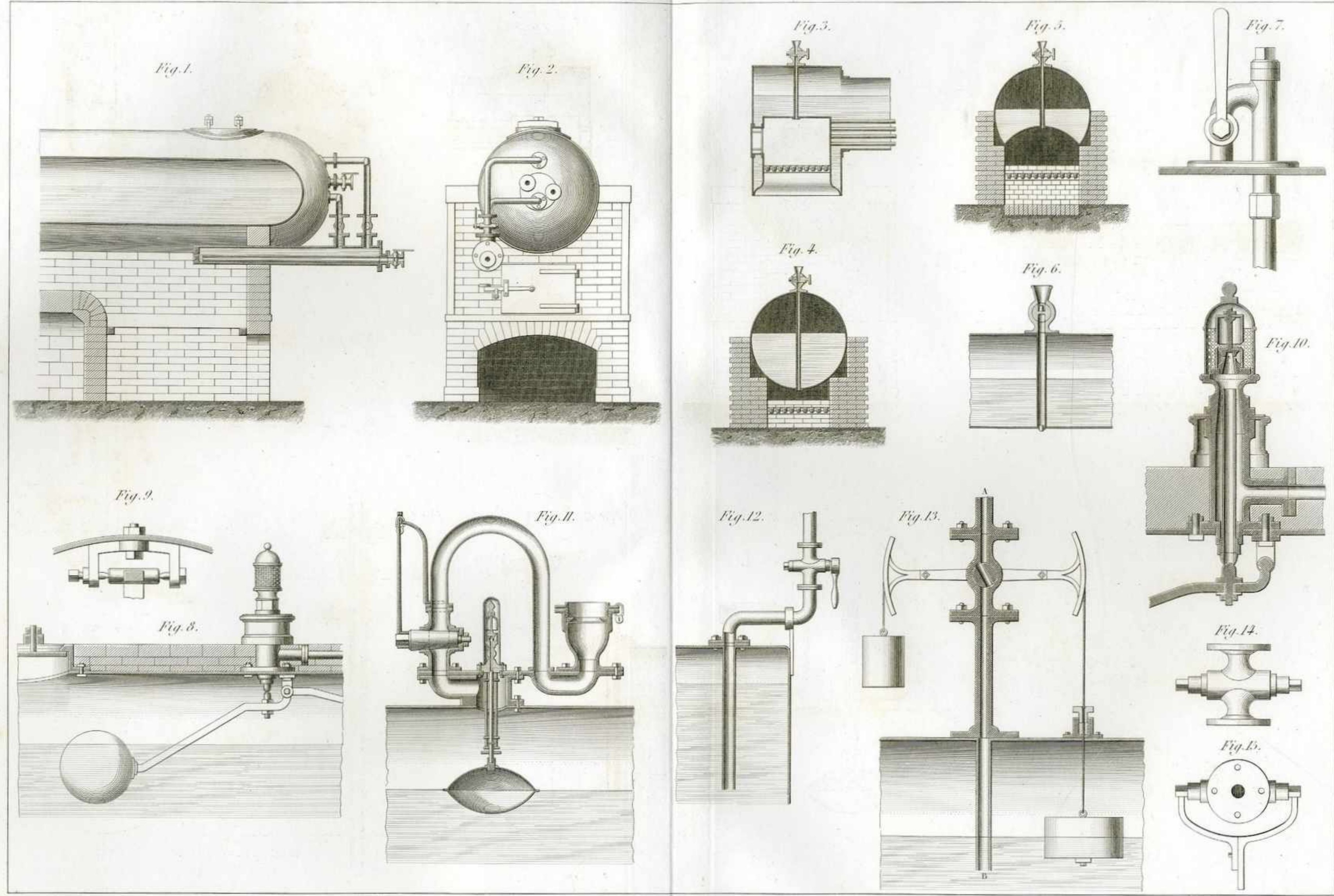


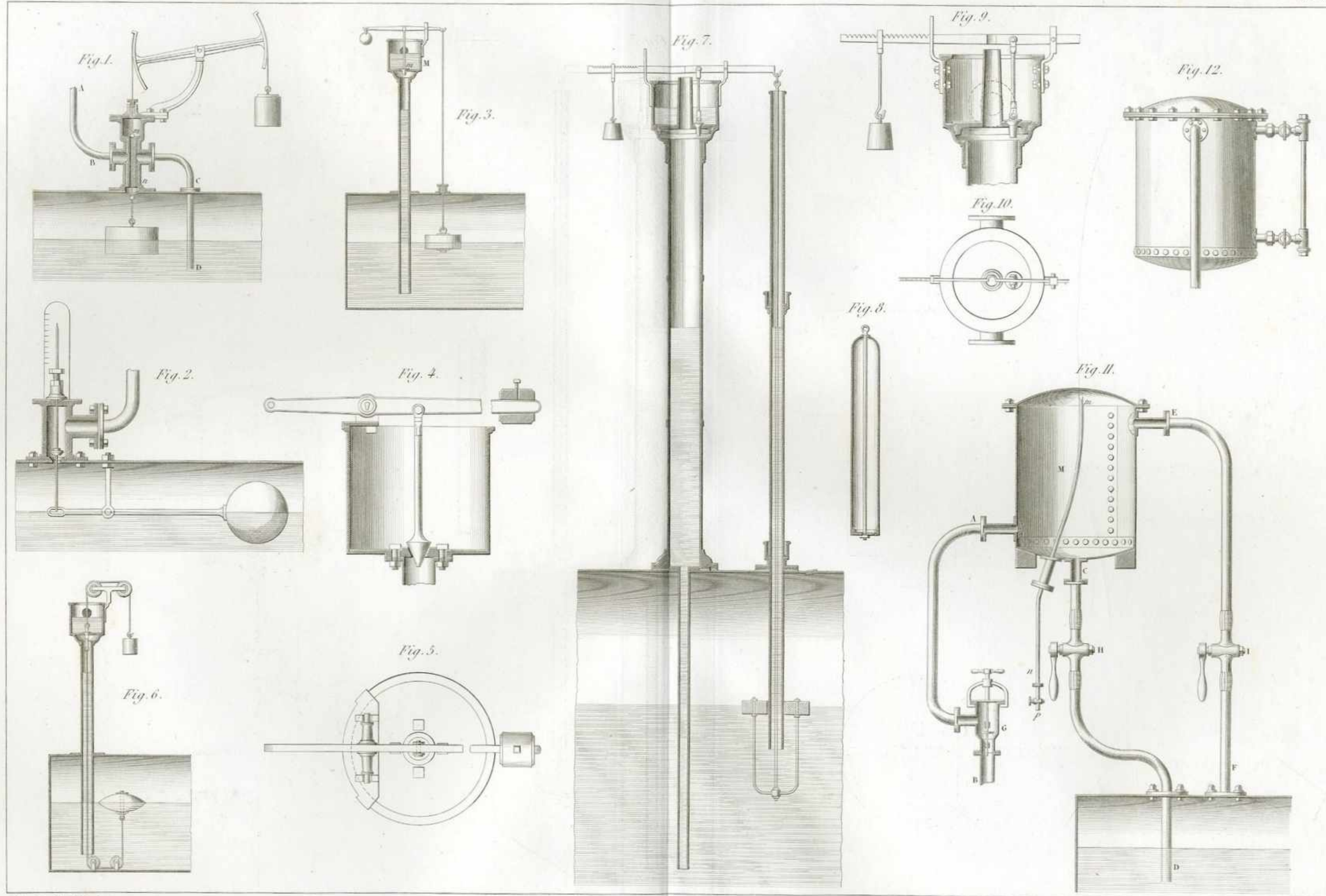


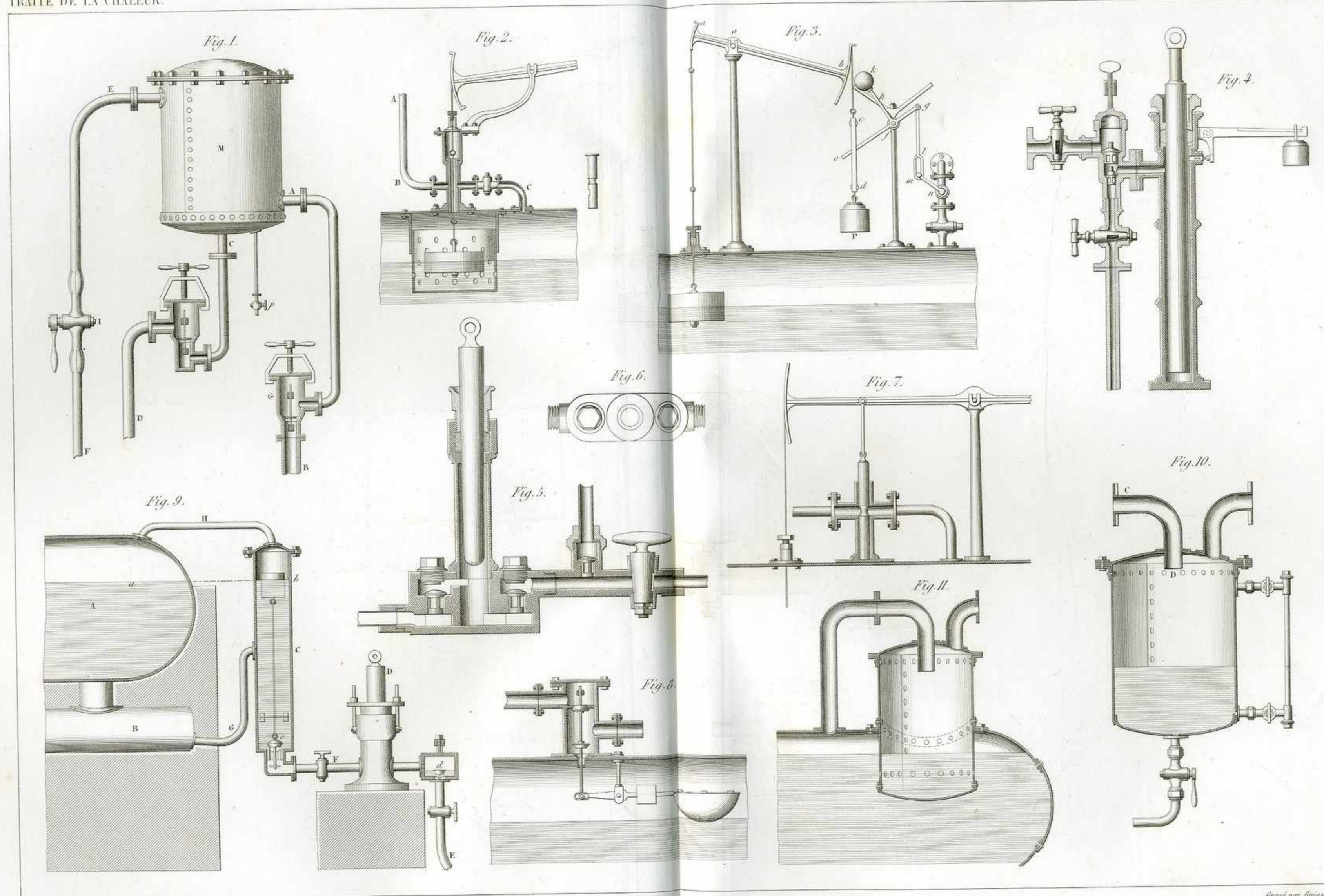


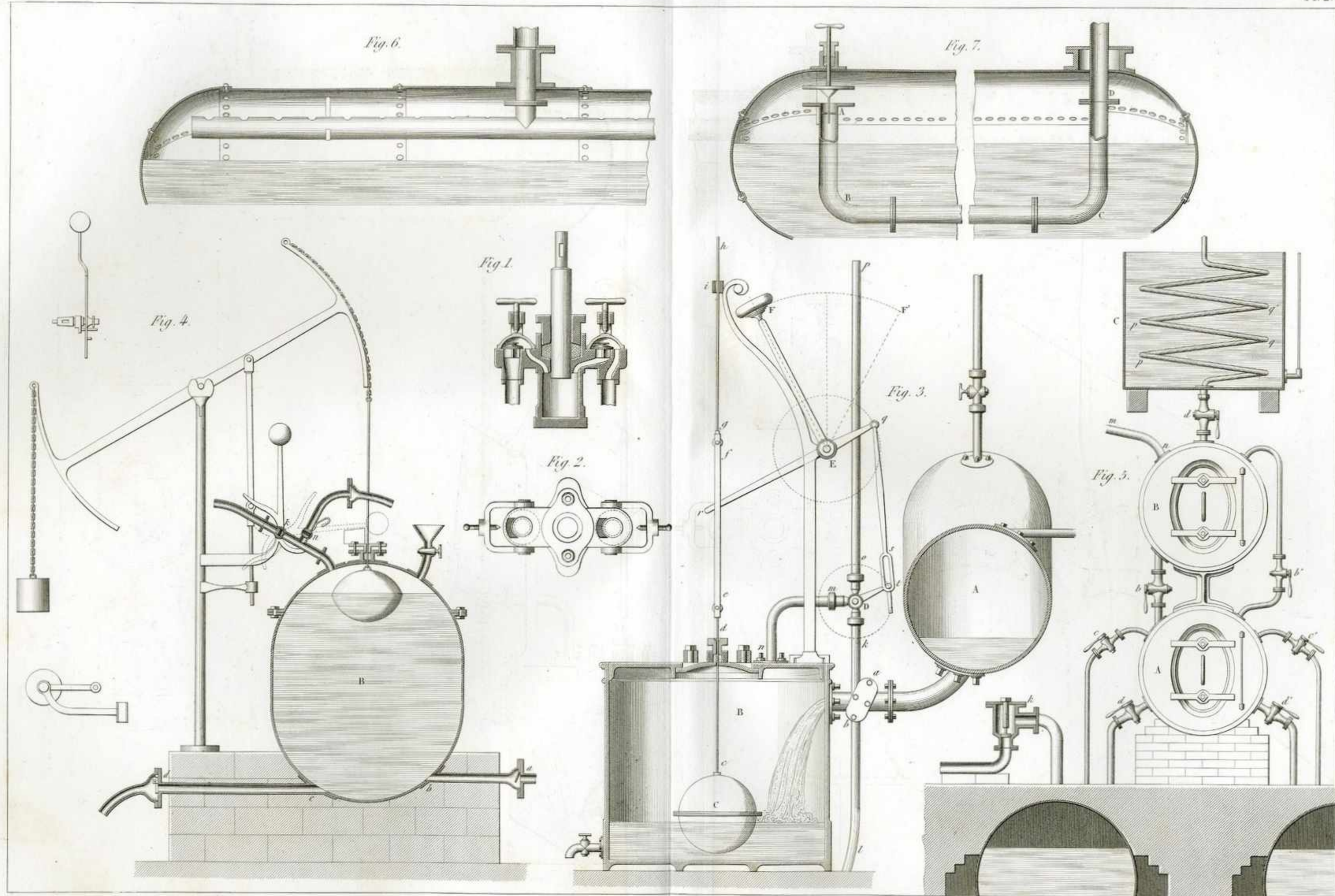


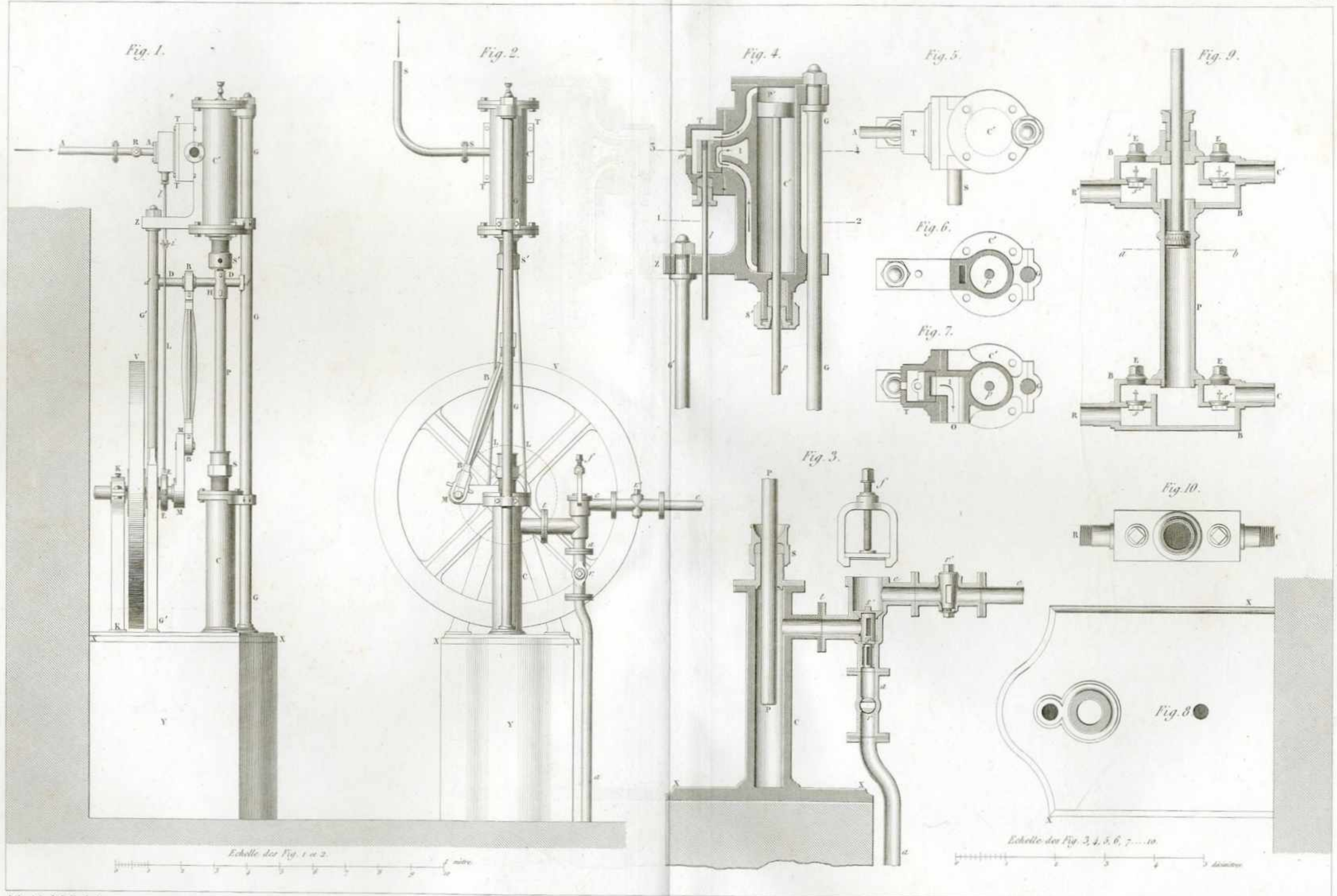


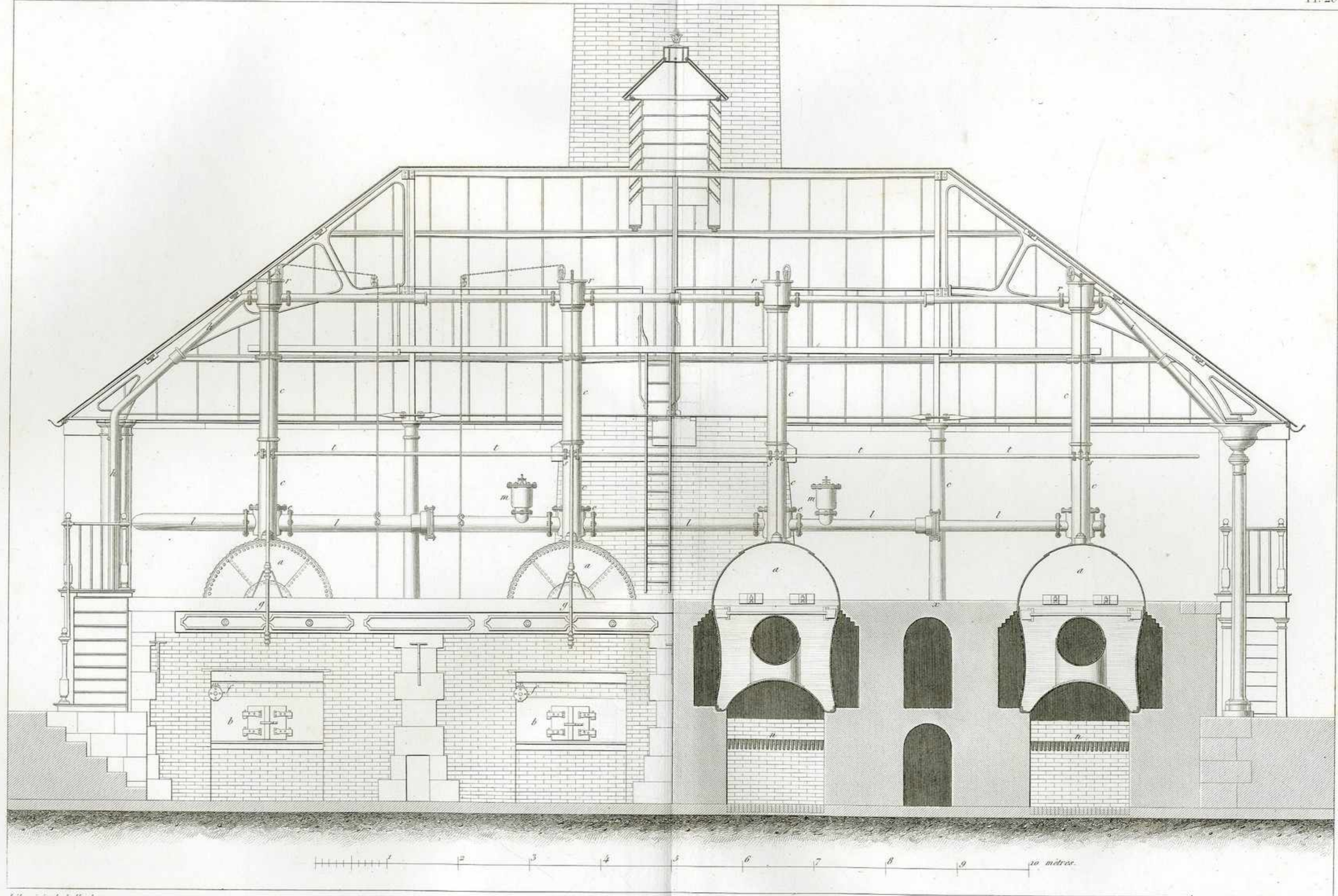


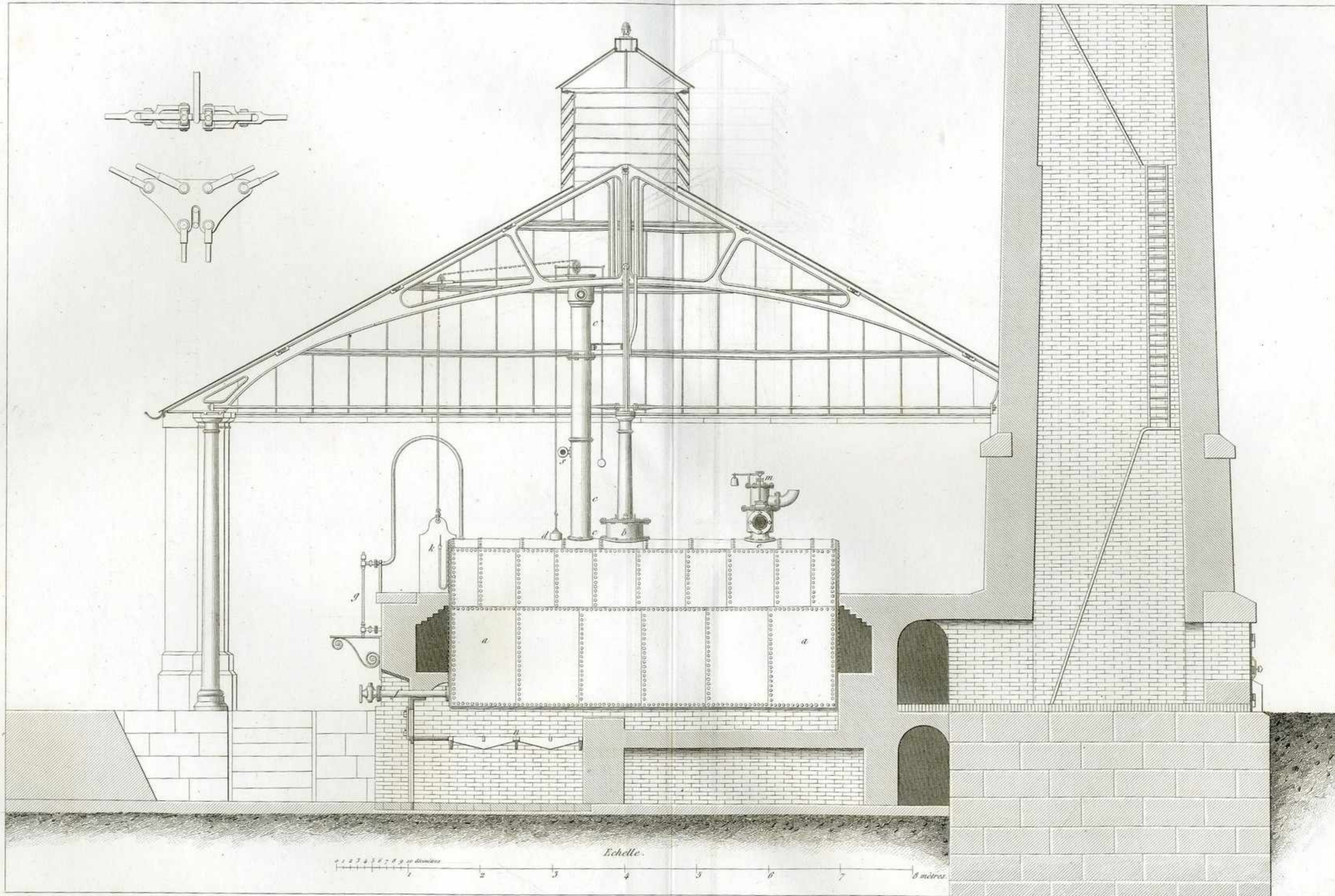












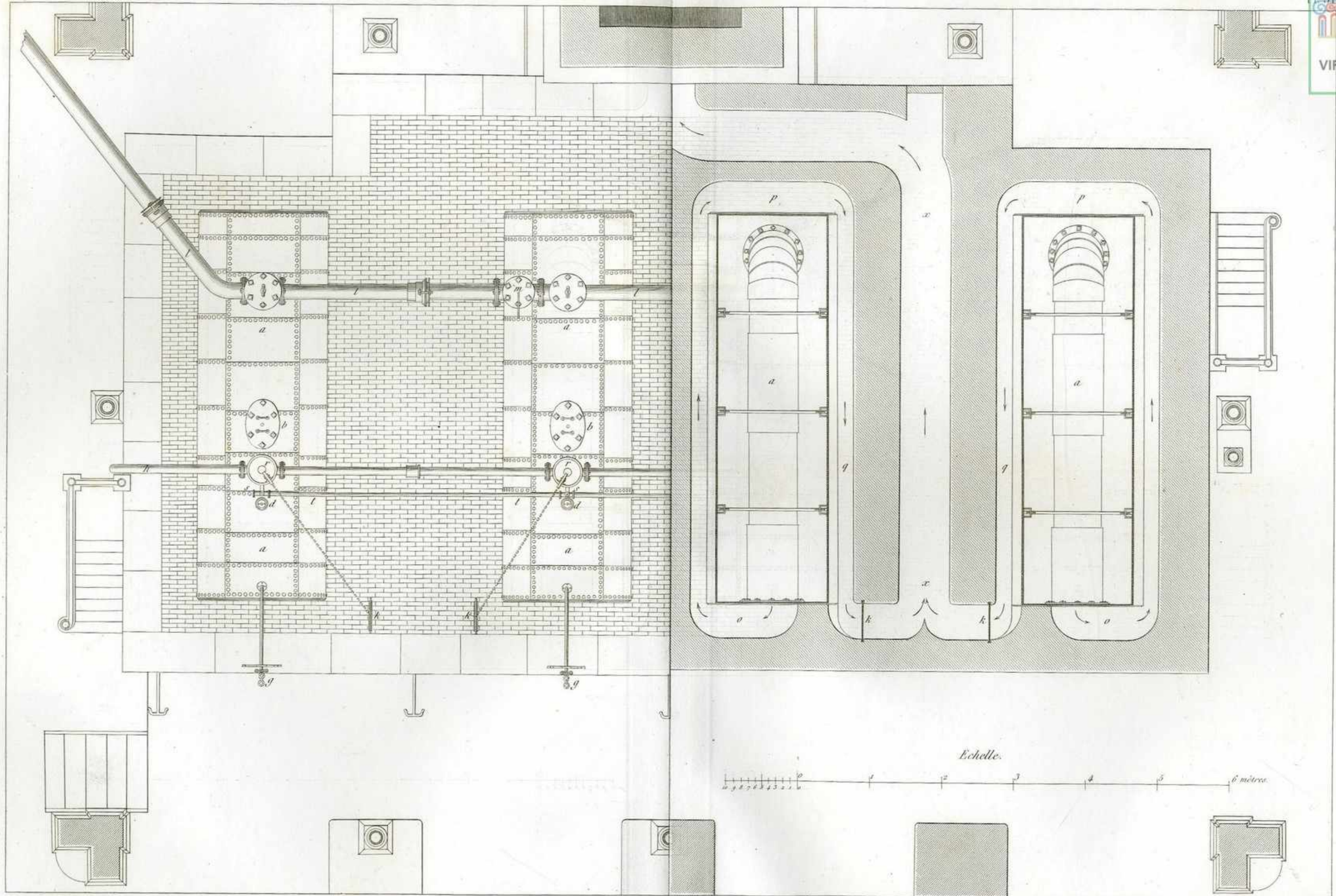




Fig. 1.

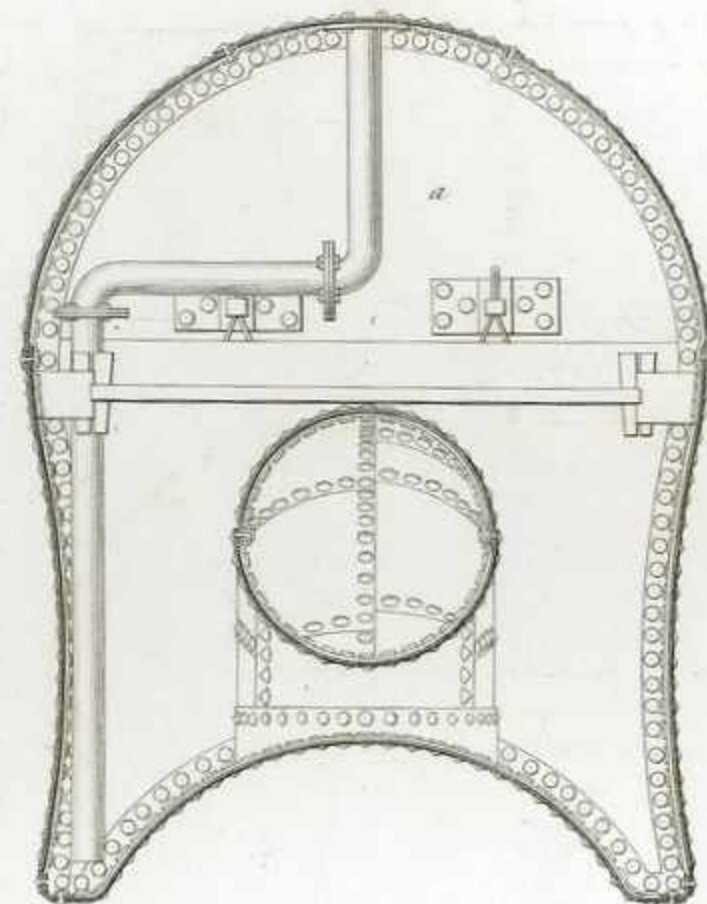


Fig. 2.

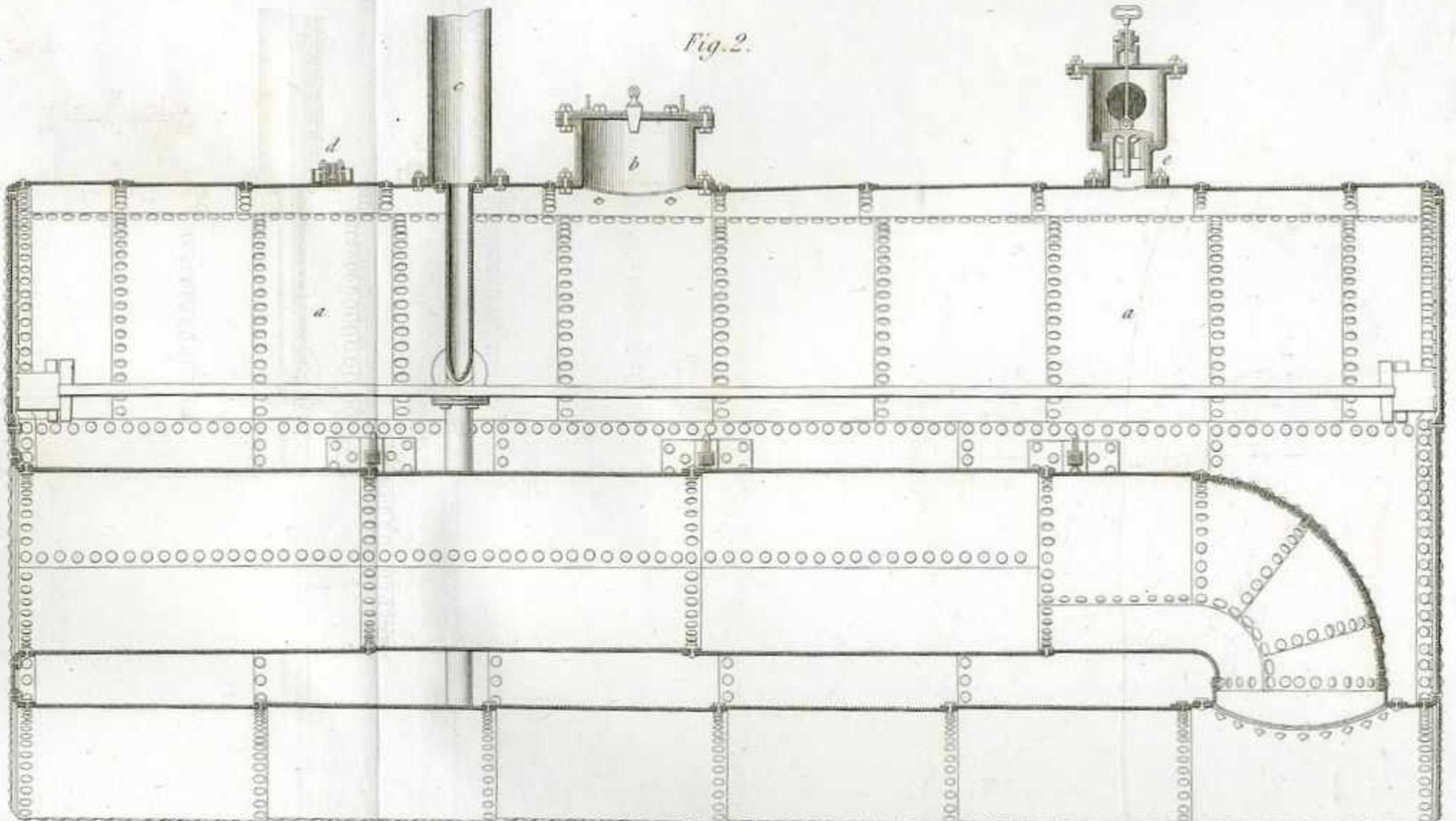


Fig. 17.

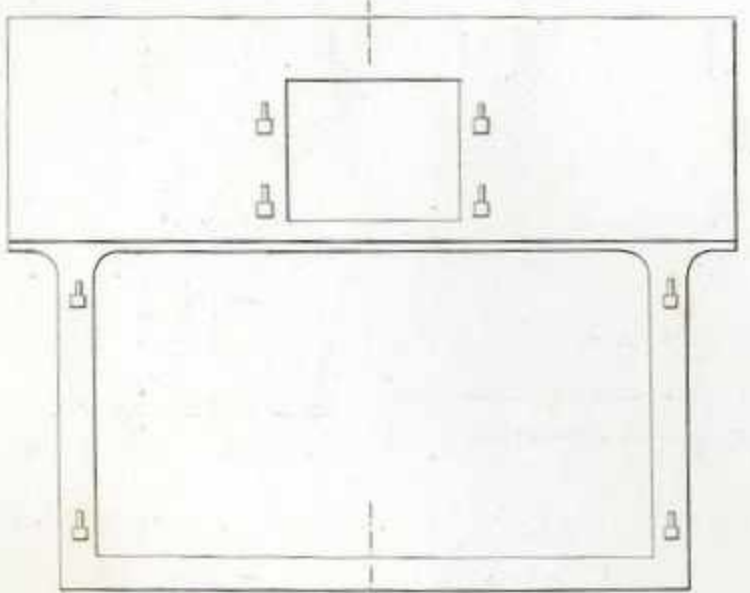


Fig. 18.



Fig. 20.

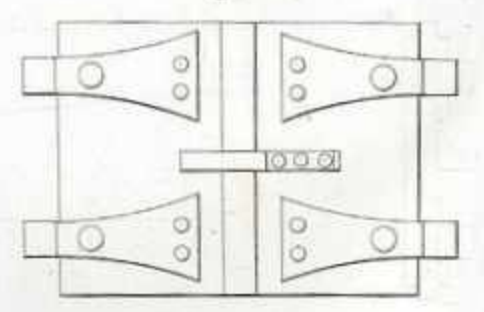


Fig. 21.

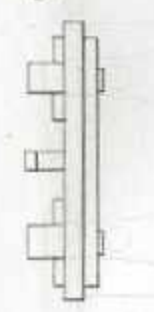


Fig. 6.



Fig. 8.



Fig. 9.



Fig. 10.



Fig. 7.



Fig. 3.



Fig. 22.



Fig. 4.

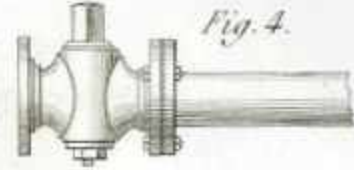


Fig. 5.

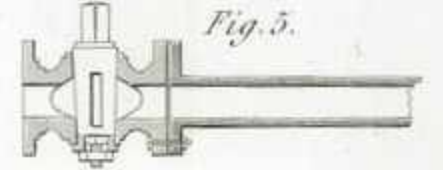


Fig. 19.

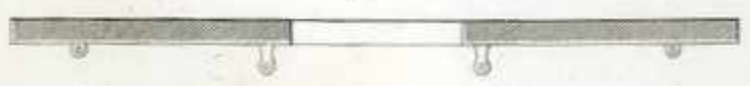


Fig. 11.



Fig. 13.



Fig. 14.



Fig. 12.



Fig. 15.



Fig. 16.



Echelle des Fig. 1, 2, 17, 18 et 19.



Echelle des Fig. 6, 7, 8, 15, 16, 20, 21 et 22.



2 mètres.

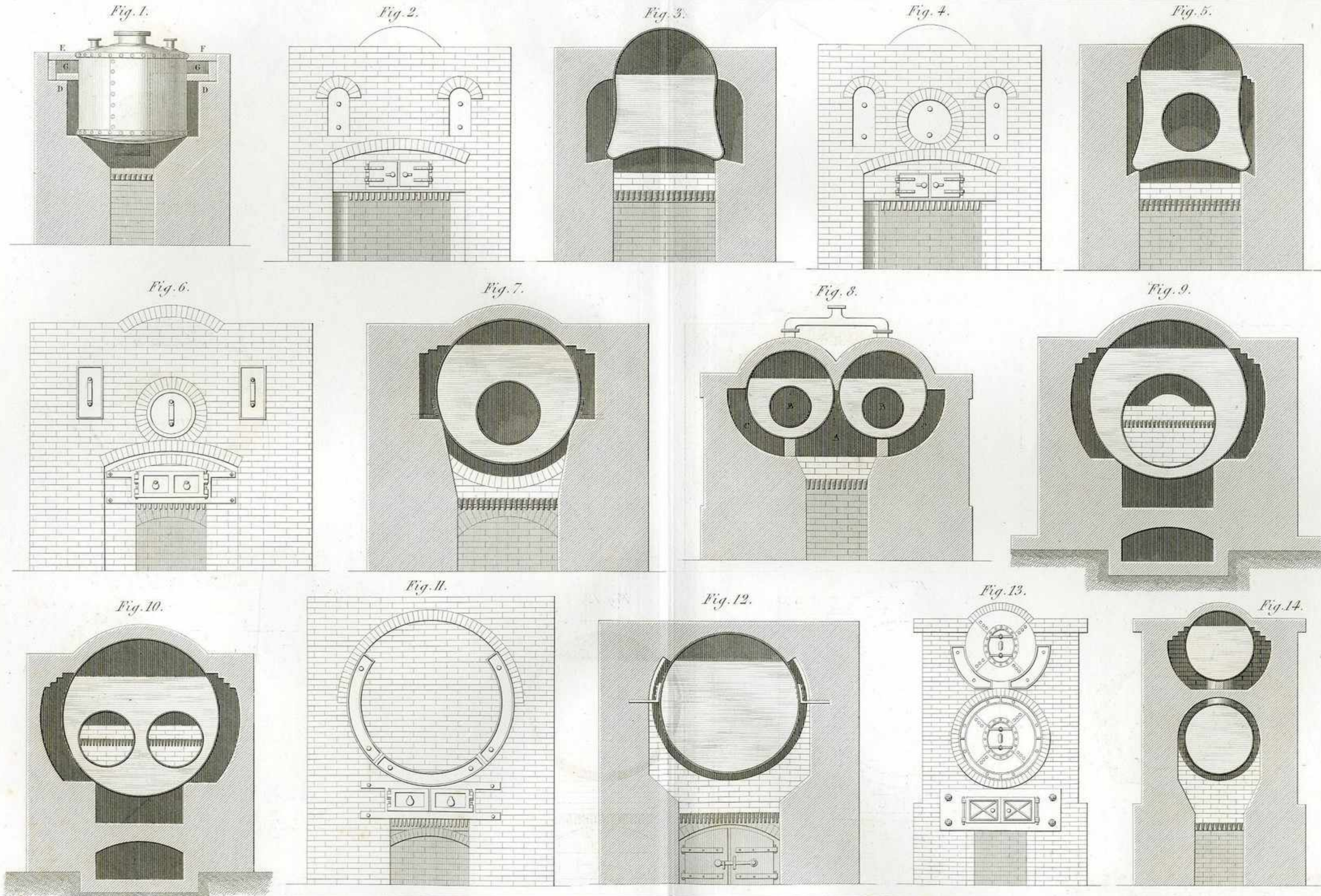




Fig. 1.

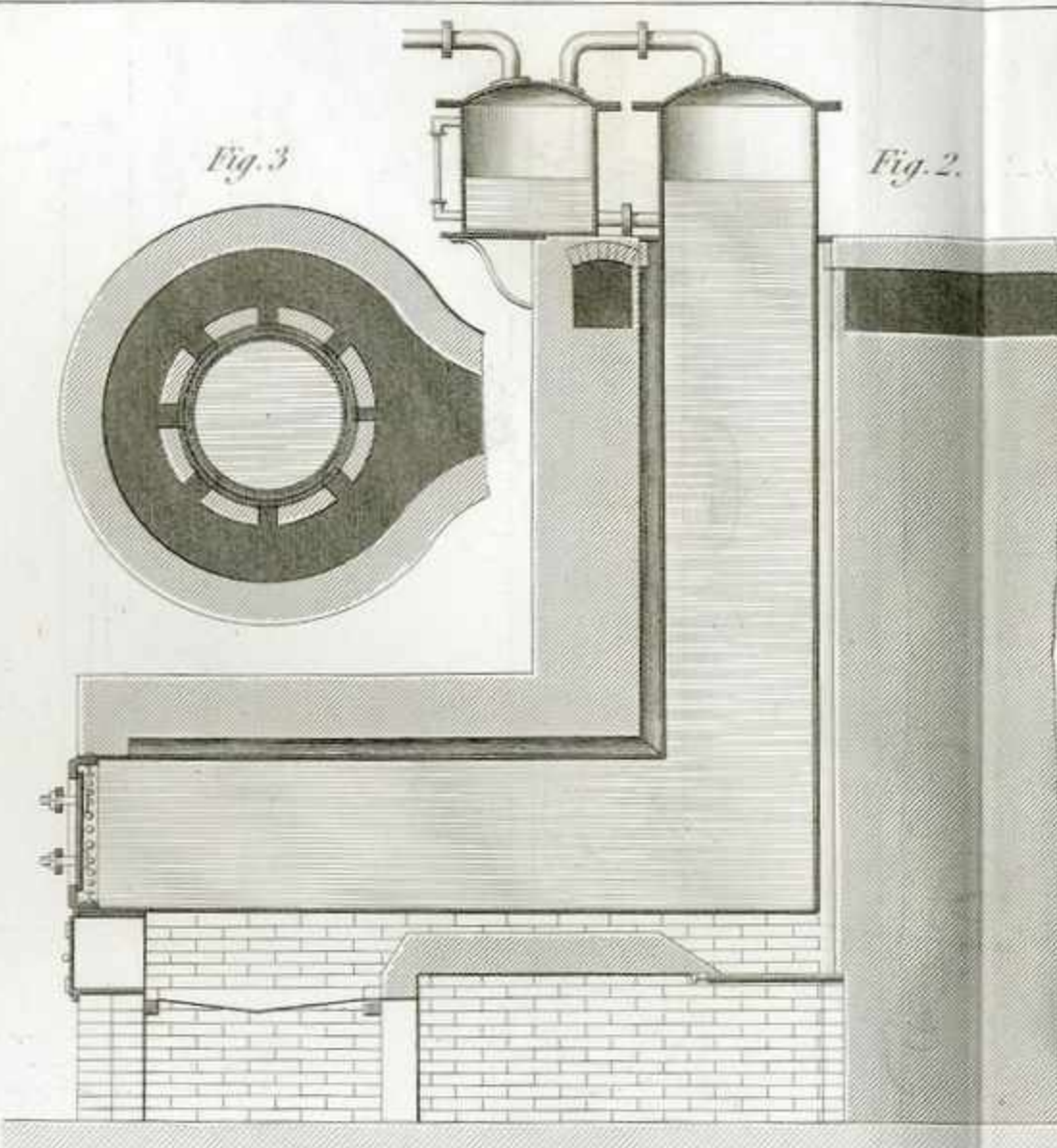


Fig. 2.

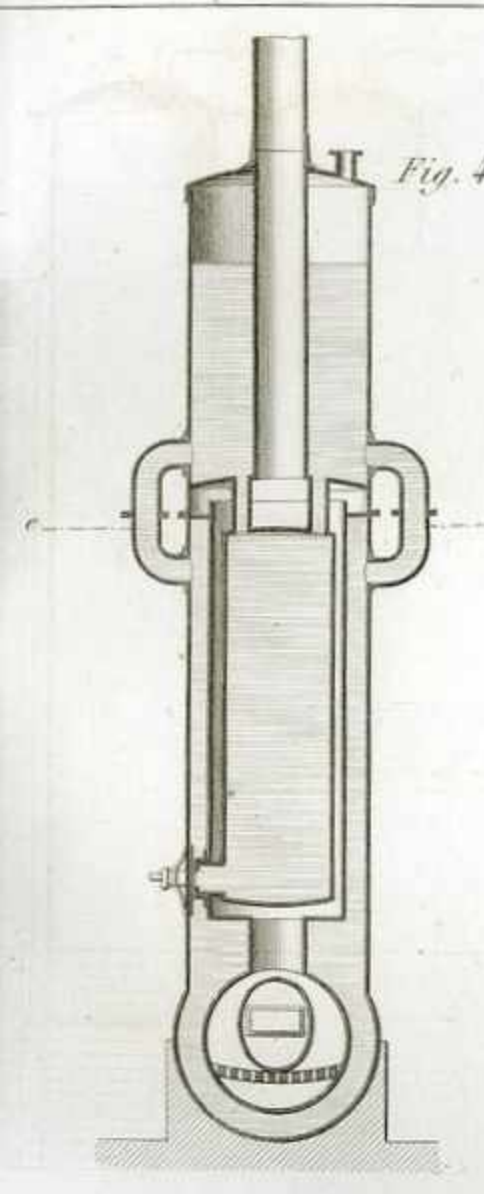


Fig. 4.

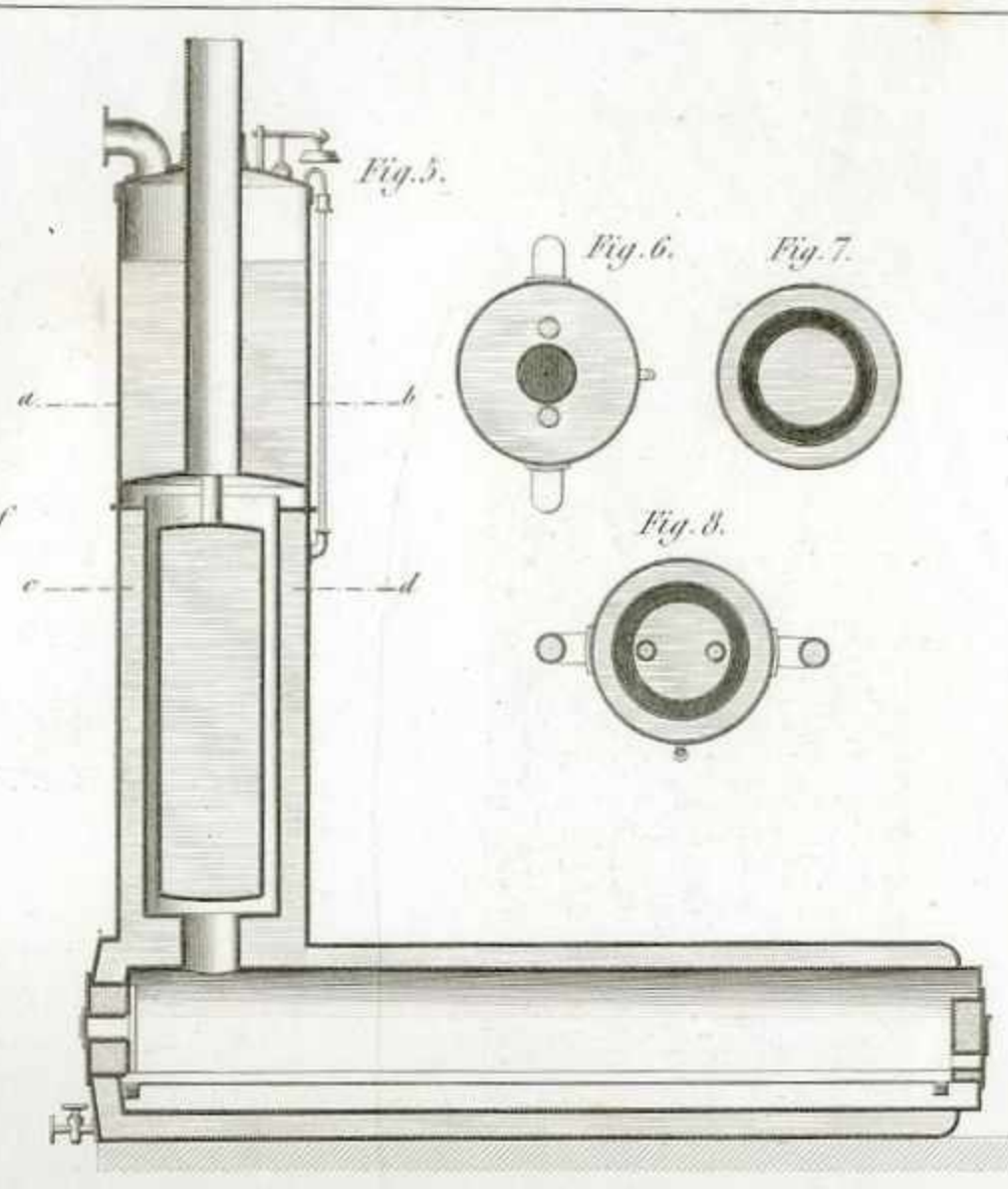


Fig. 5.

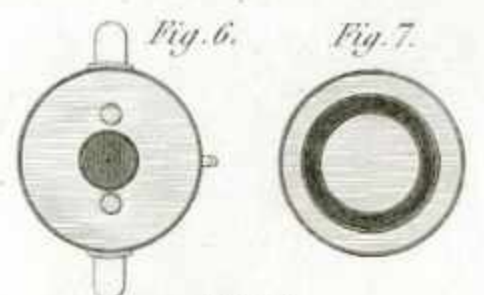


Fig. 6.

Fig. 7.

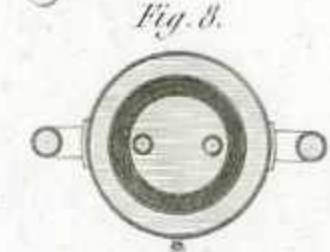


Fig. 8.

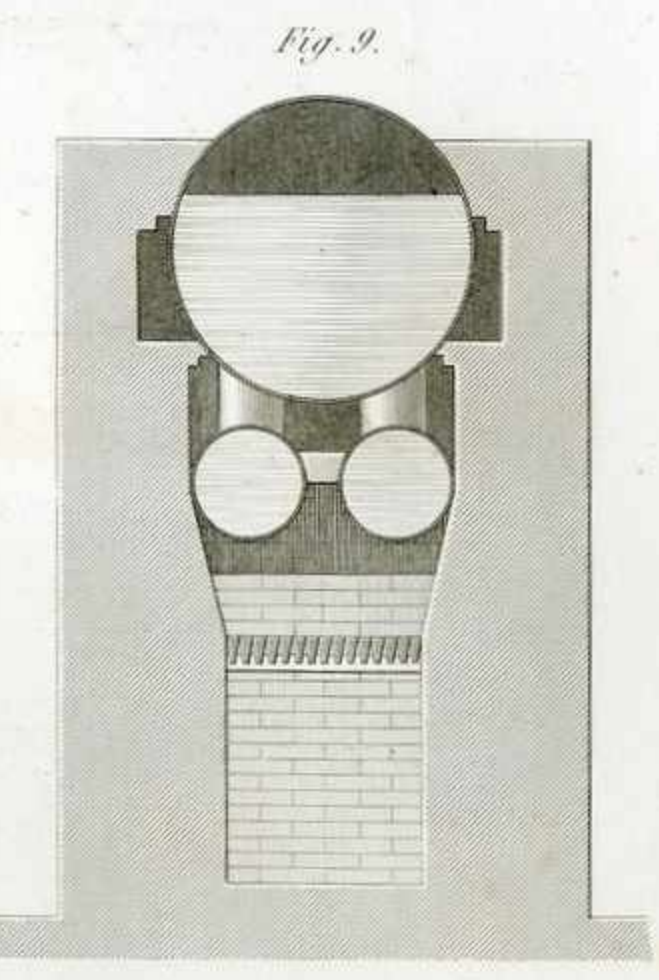


Fig. 9.

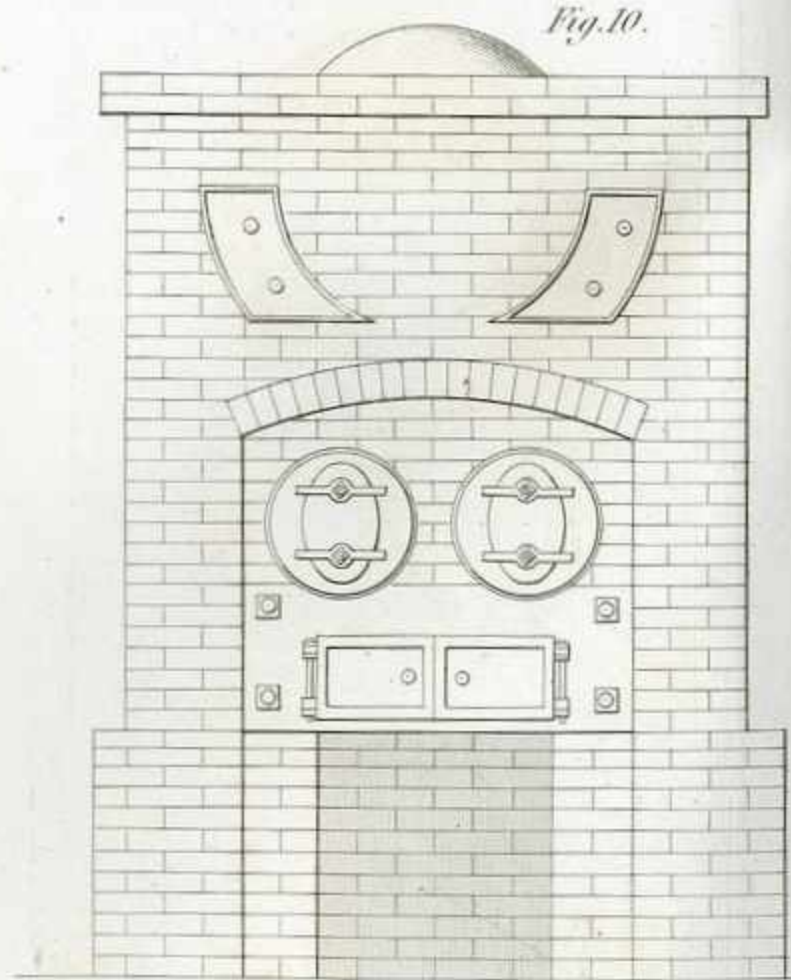


Fig. 10.

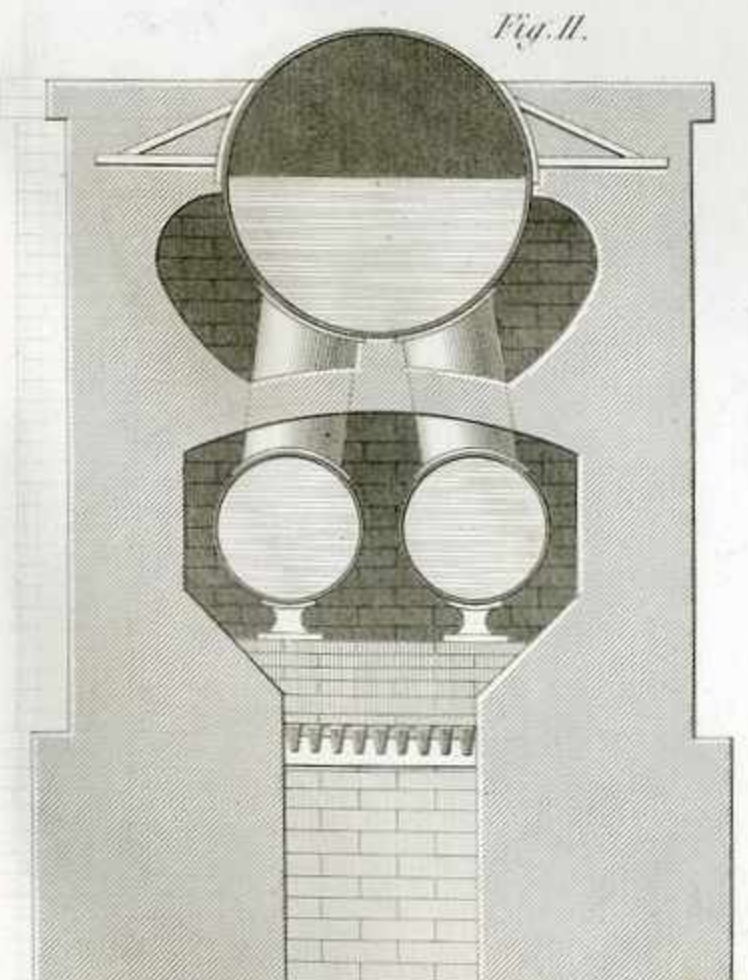


Fig. 11.

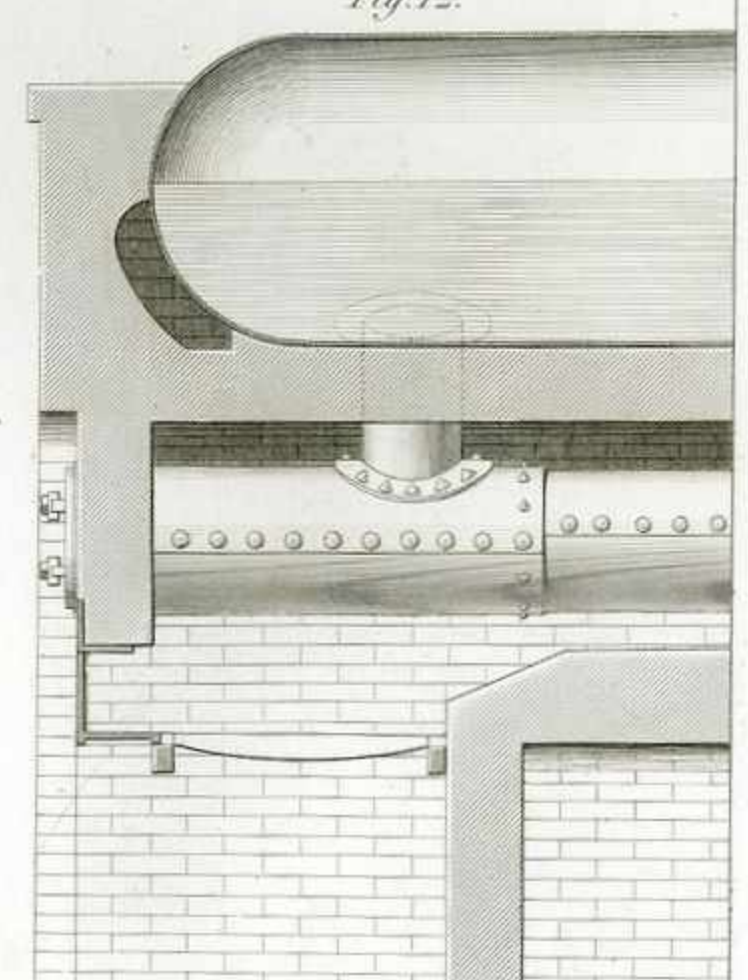


Fig. 12.

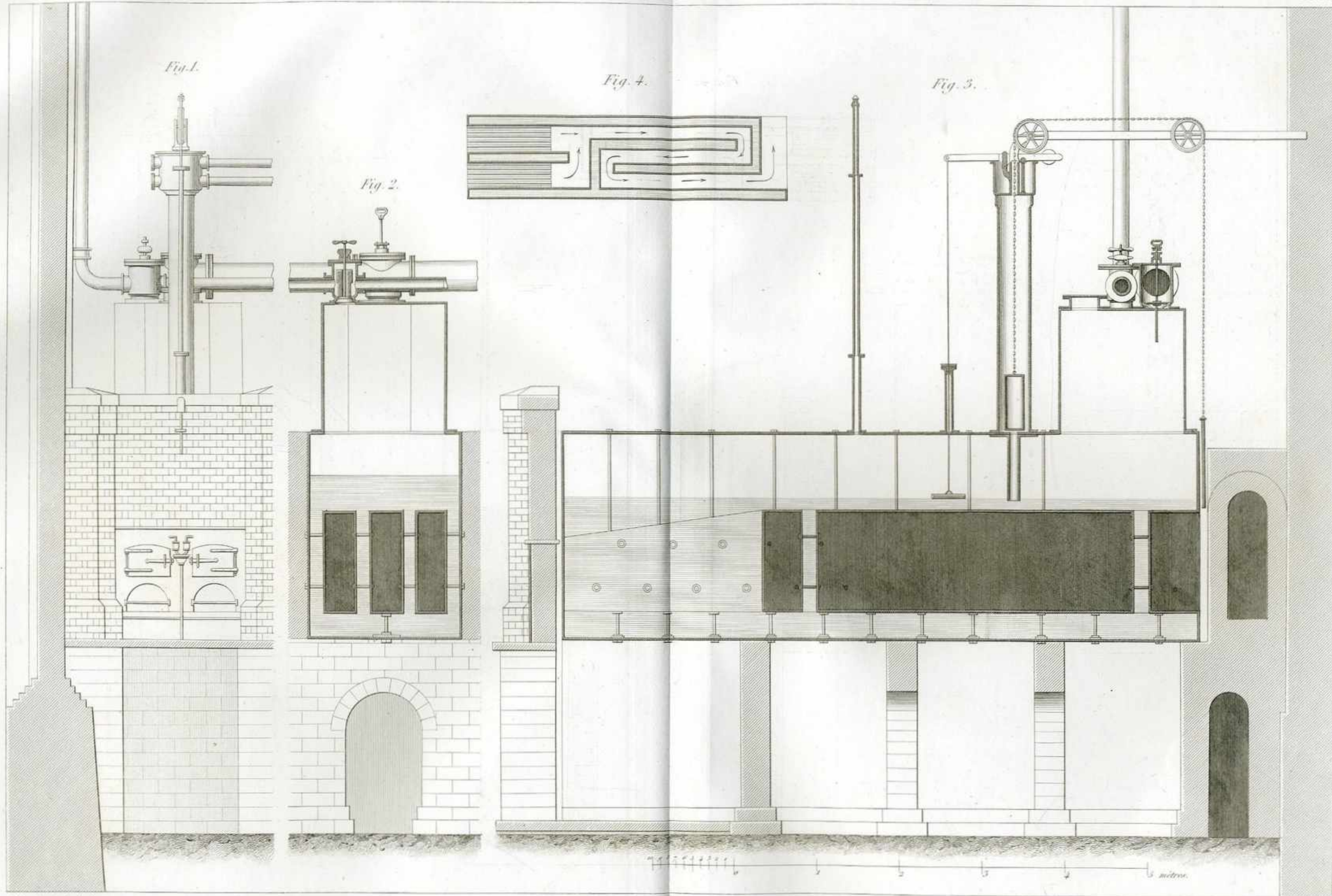




Fig. 1.

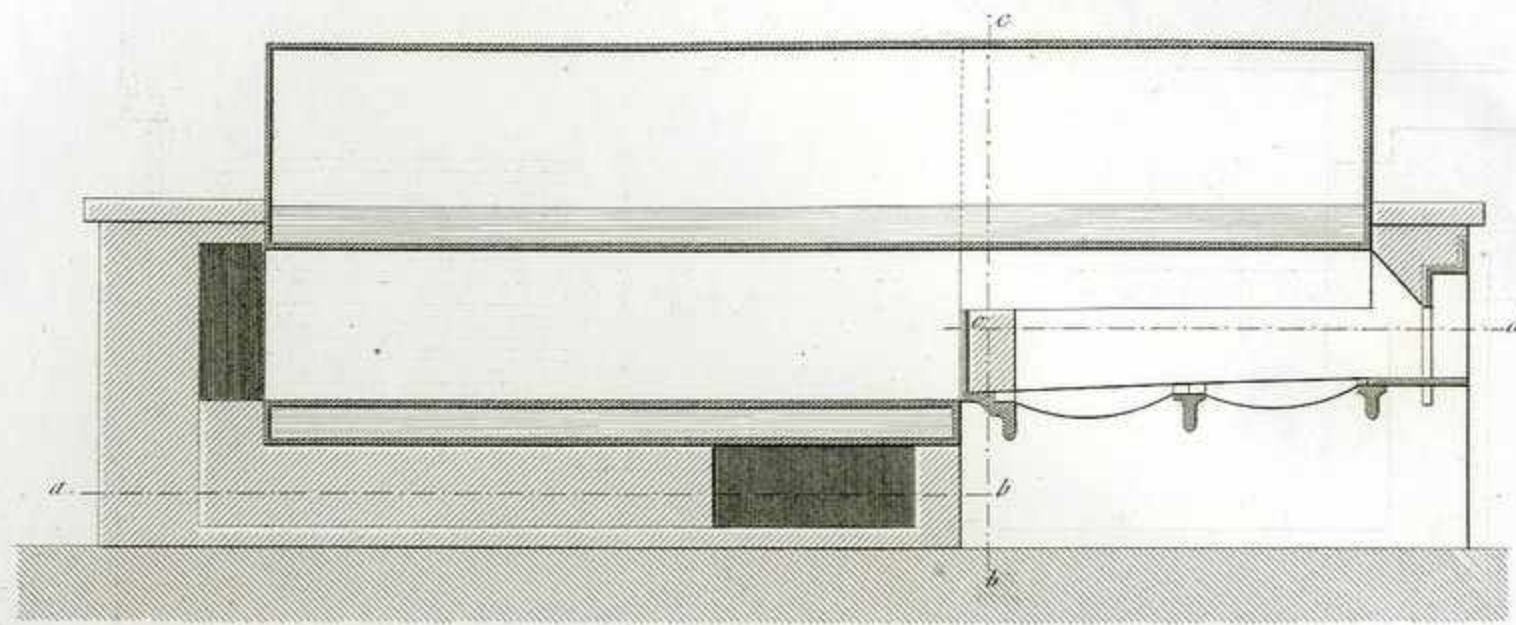


Fig. 2.

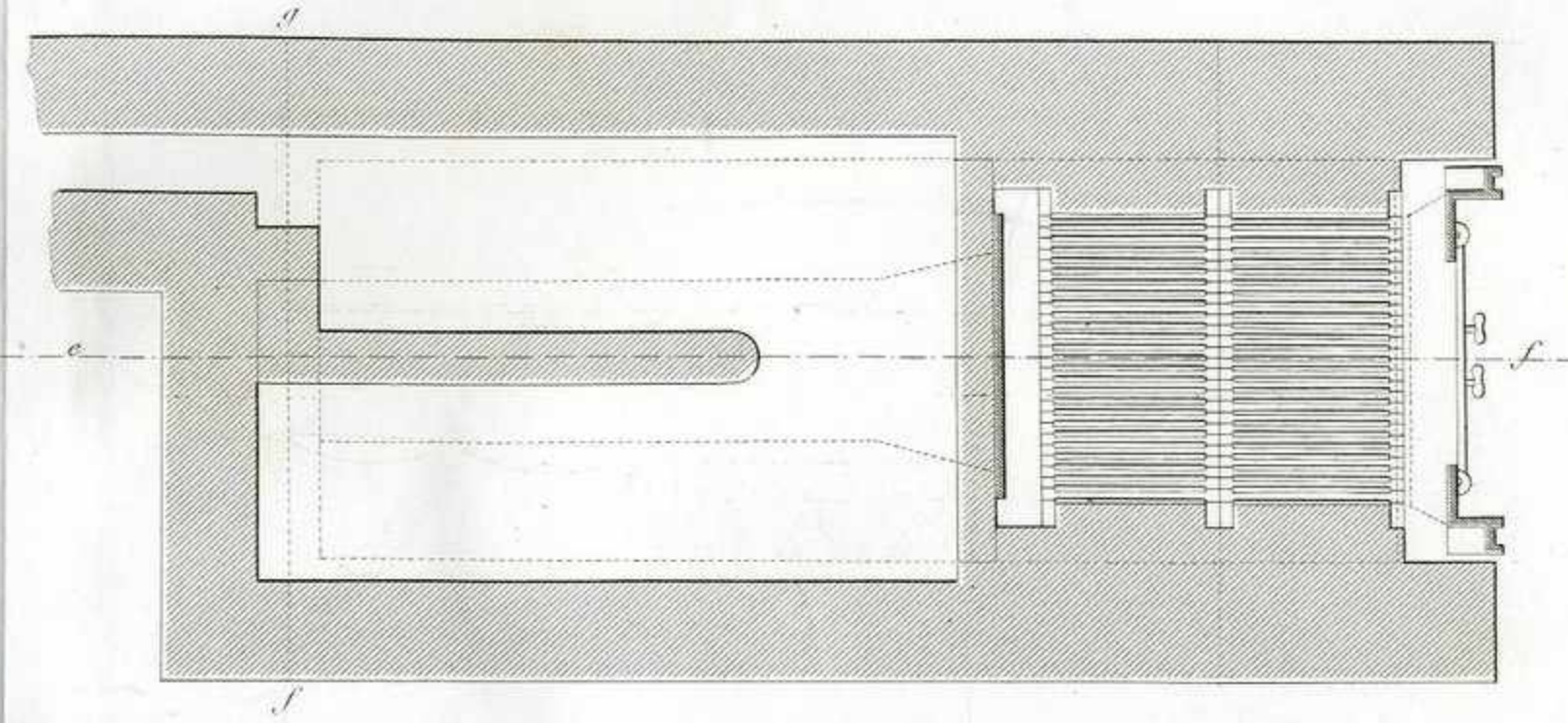


Fig. 3.

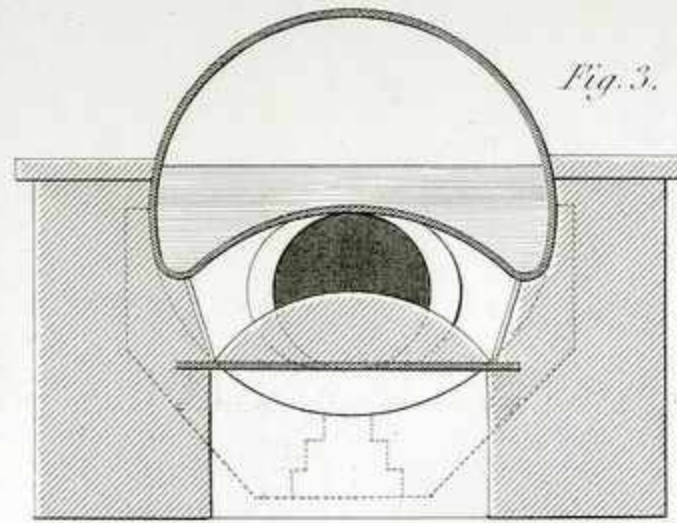
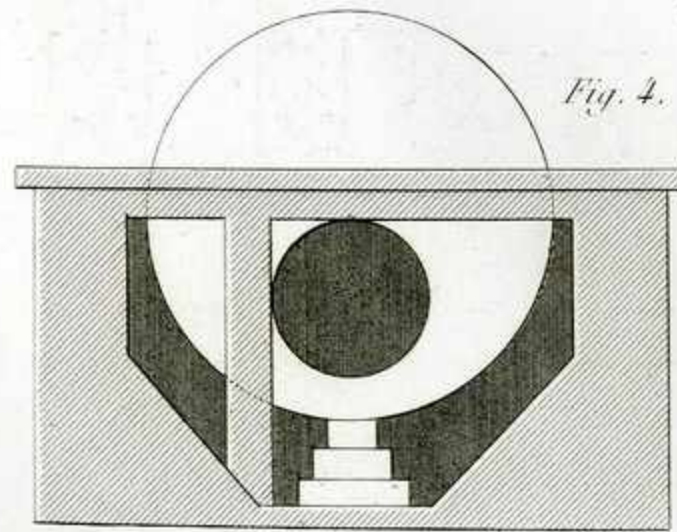


Fig. 4.



Echelle des Fig. 1, 2, 3 et 4.



Fig. 5.

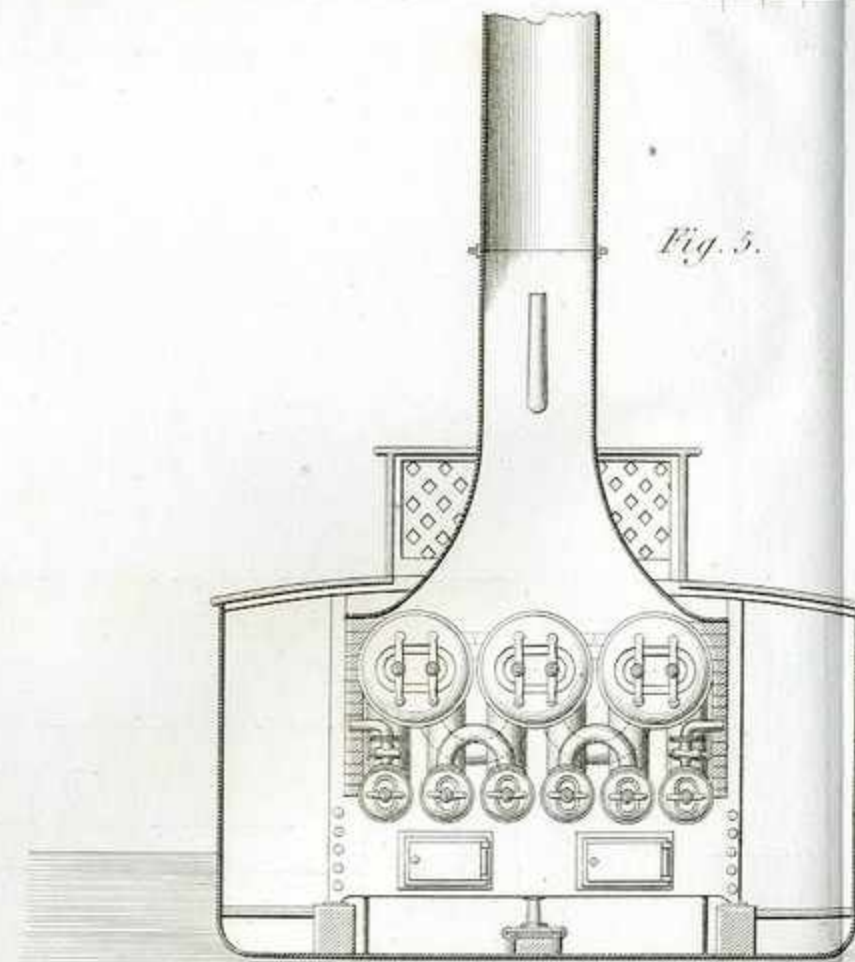
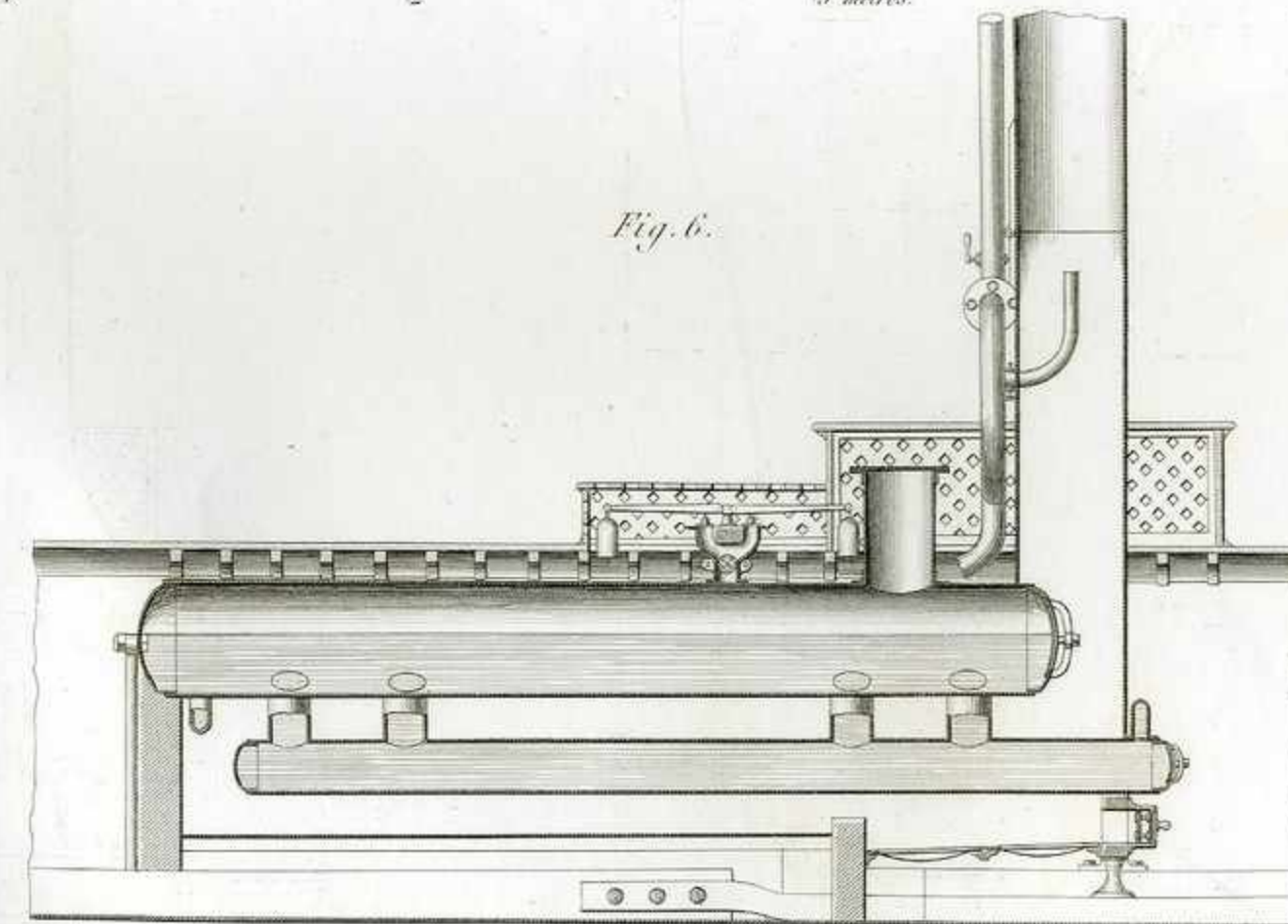
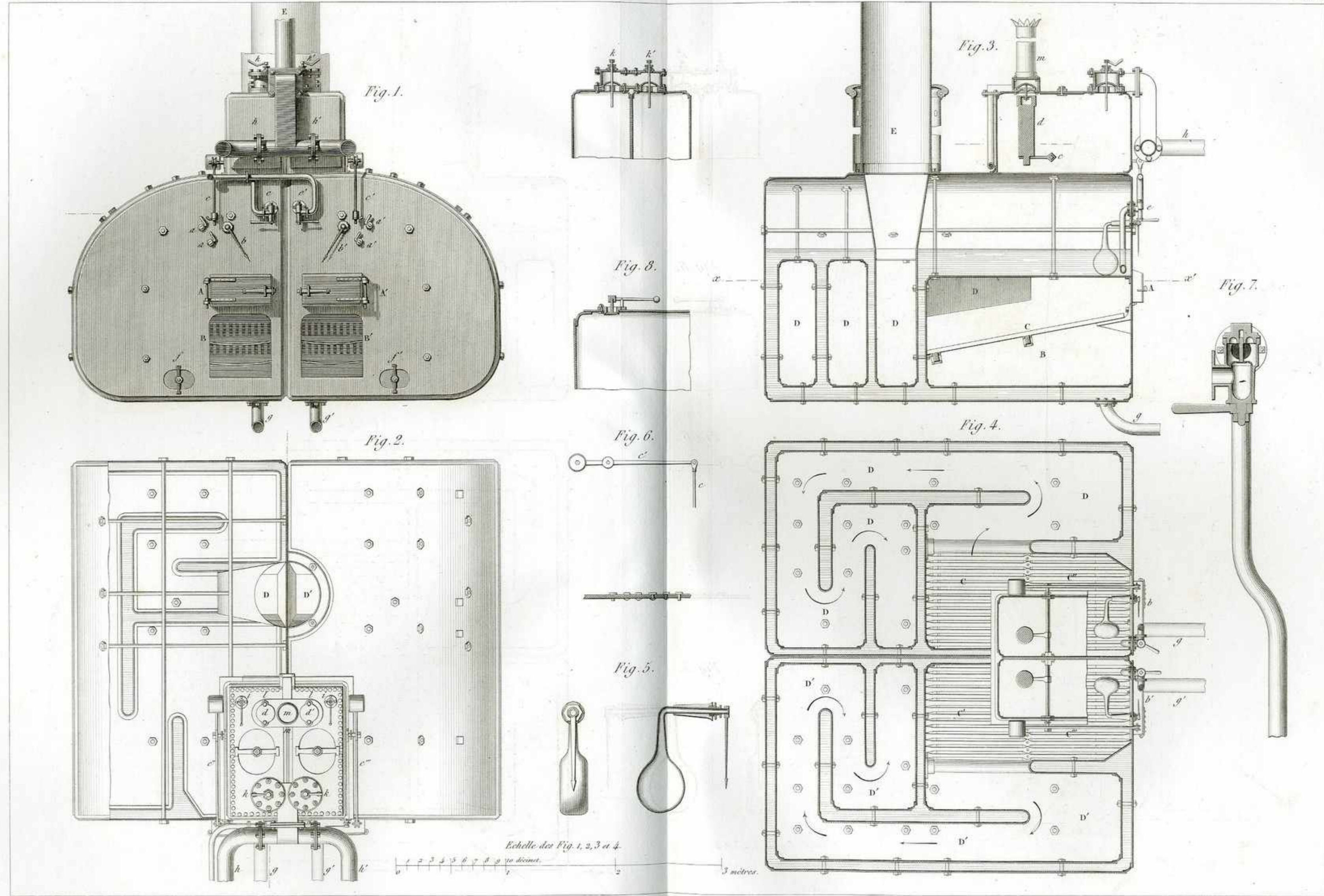


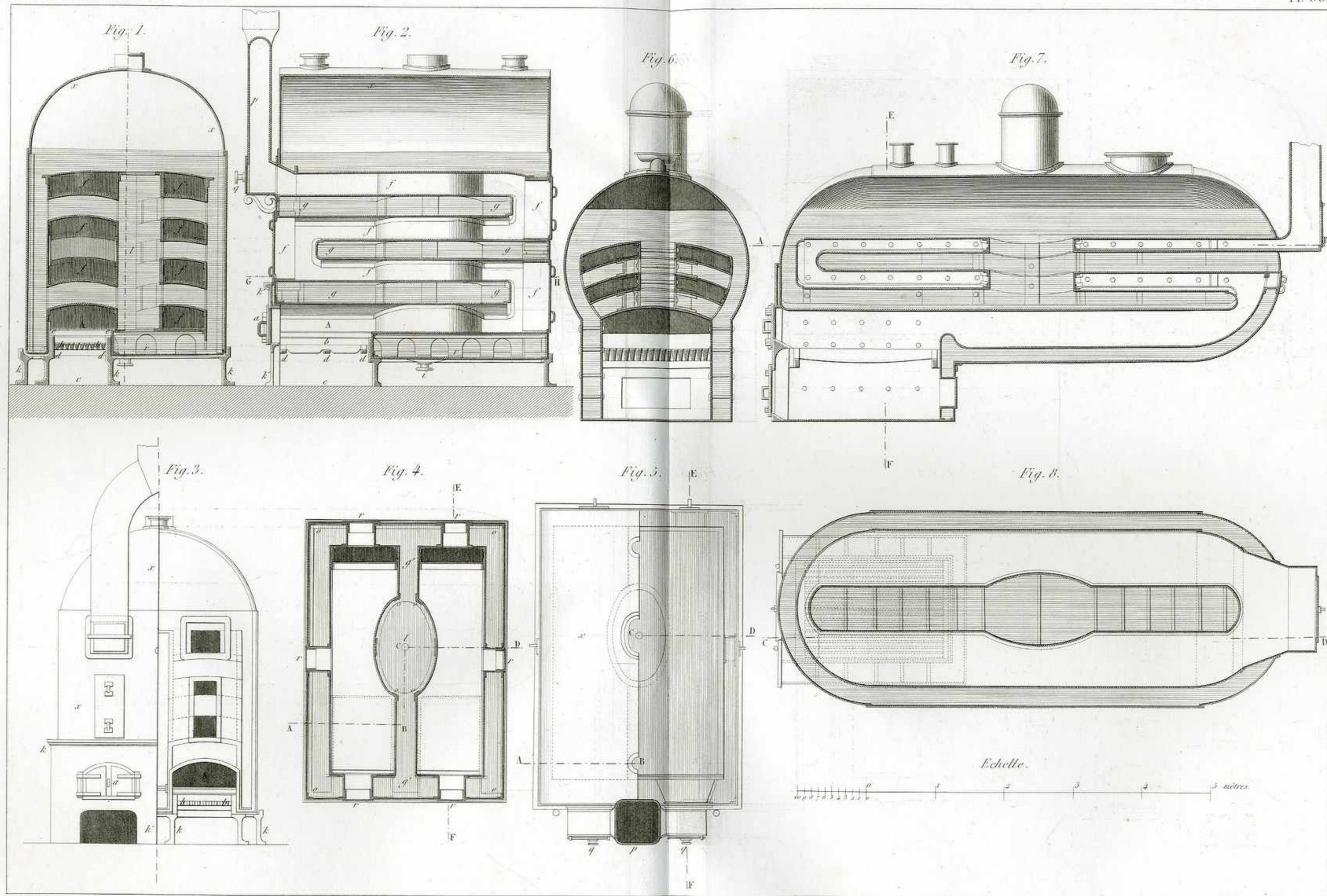
Fig. 6.

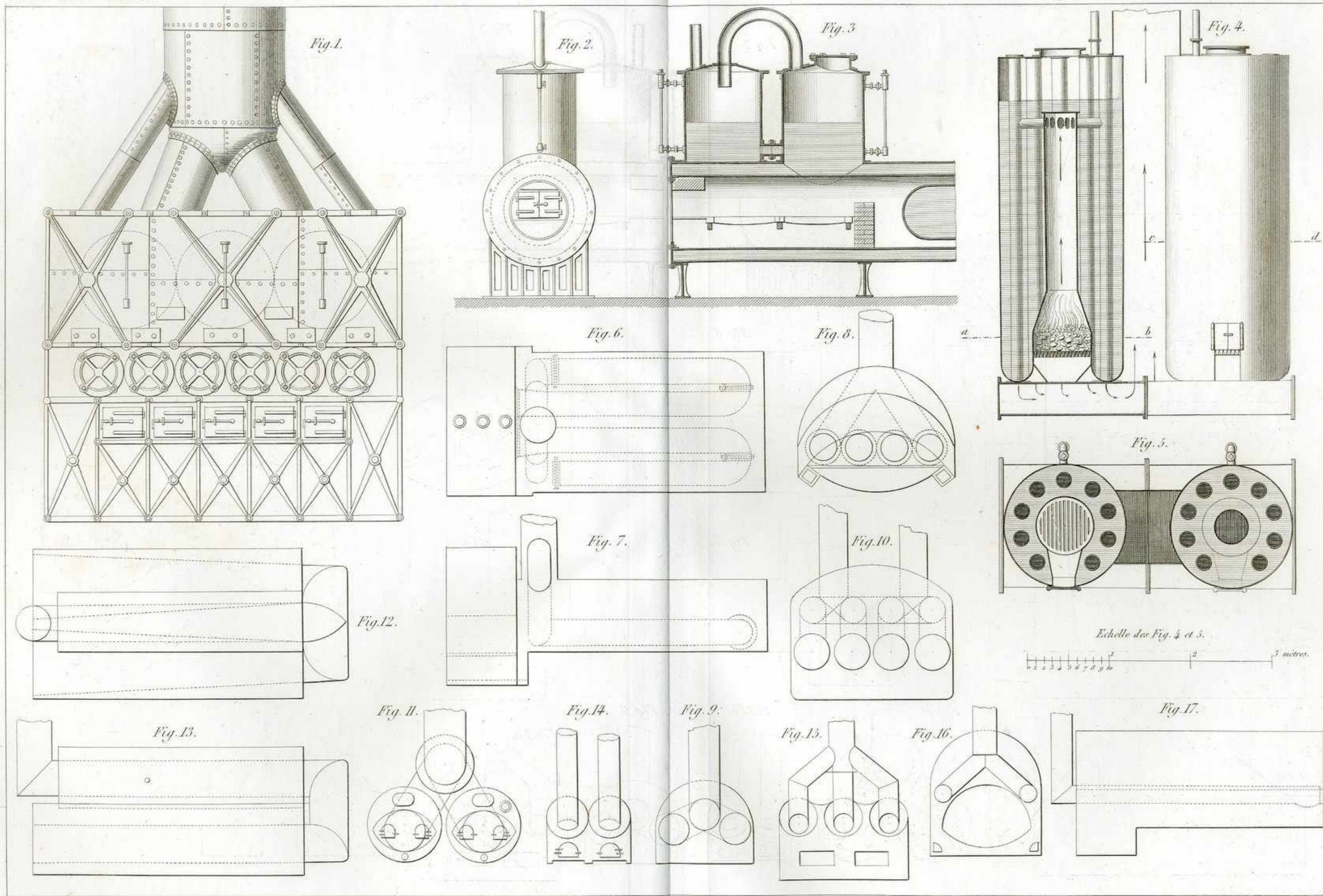


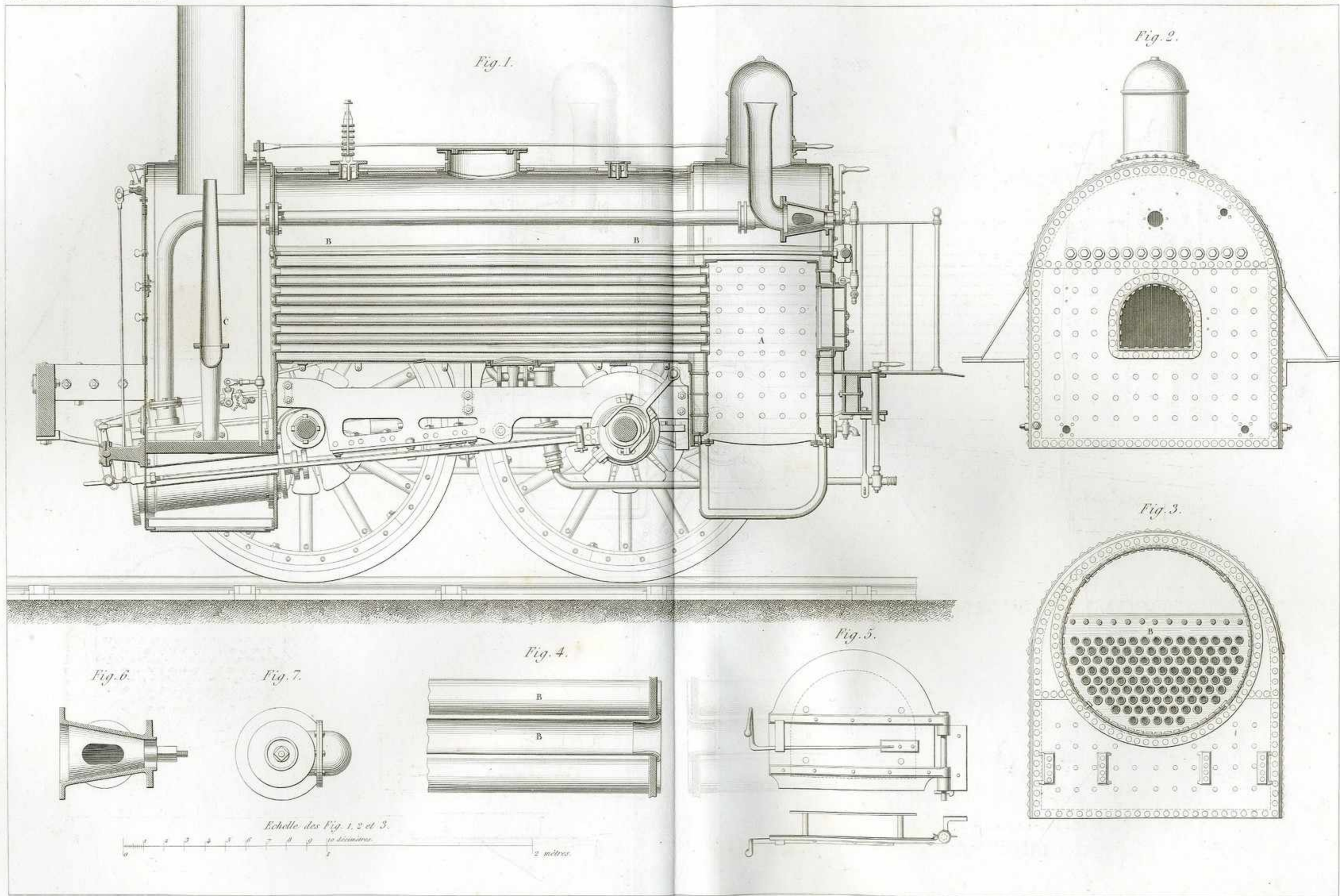
Echelle des Fig. 5 et 6.

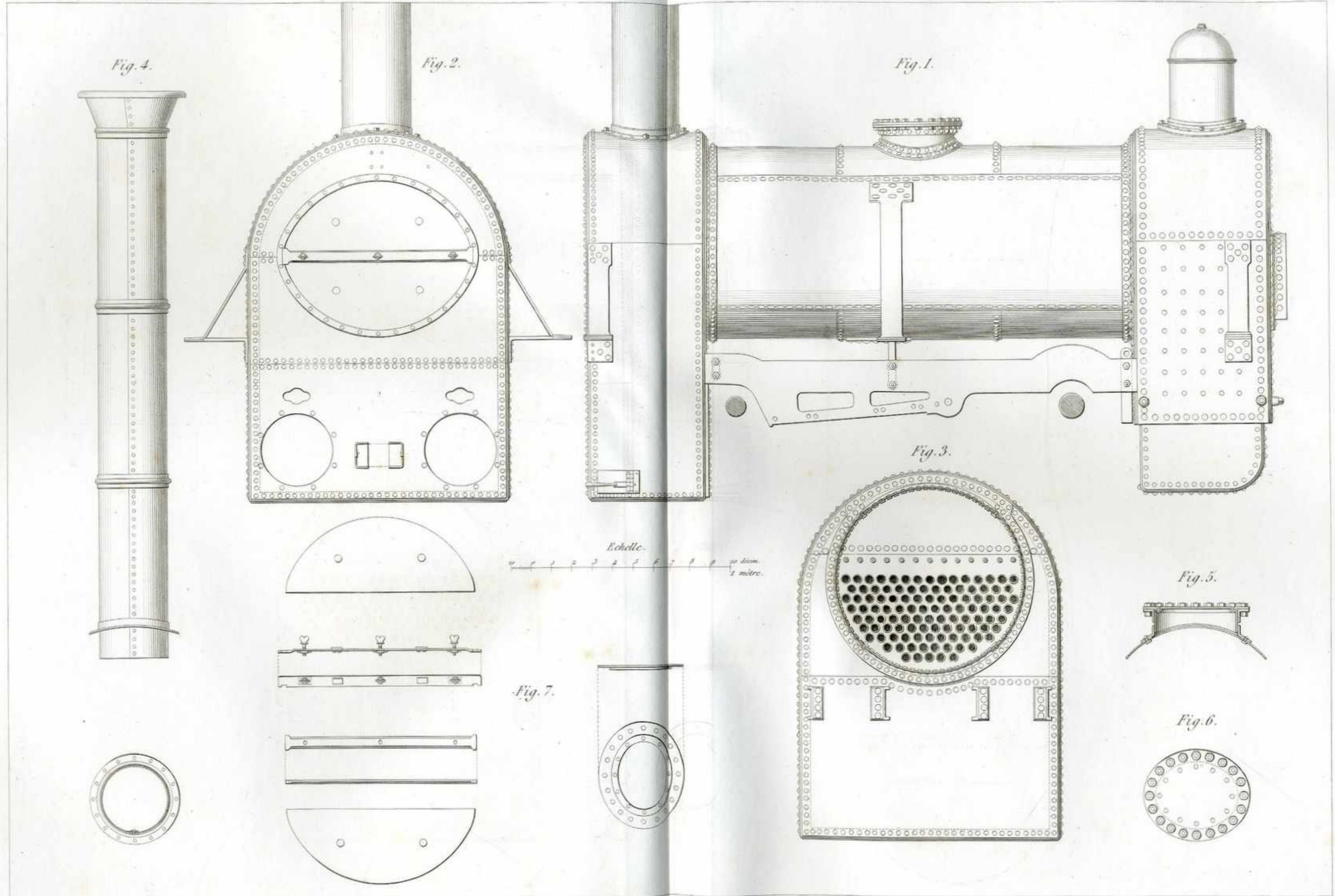












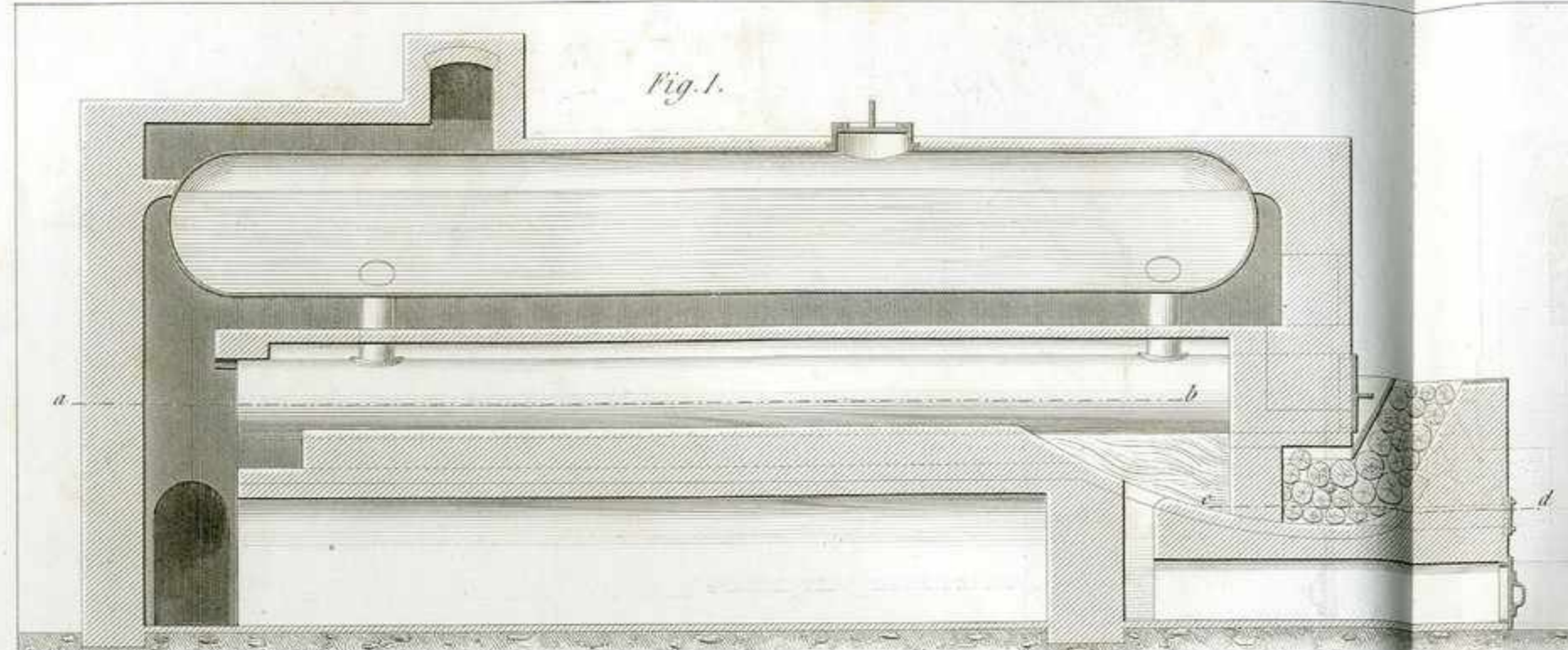


Fig. 1.

Echelle des Fig. 1, 2 et 3.
Fig. 2.

1 2 3 4 5 mètres.

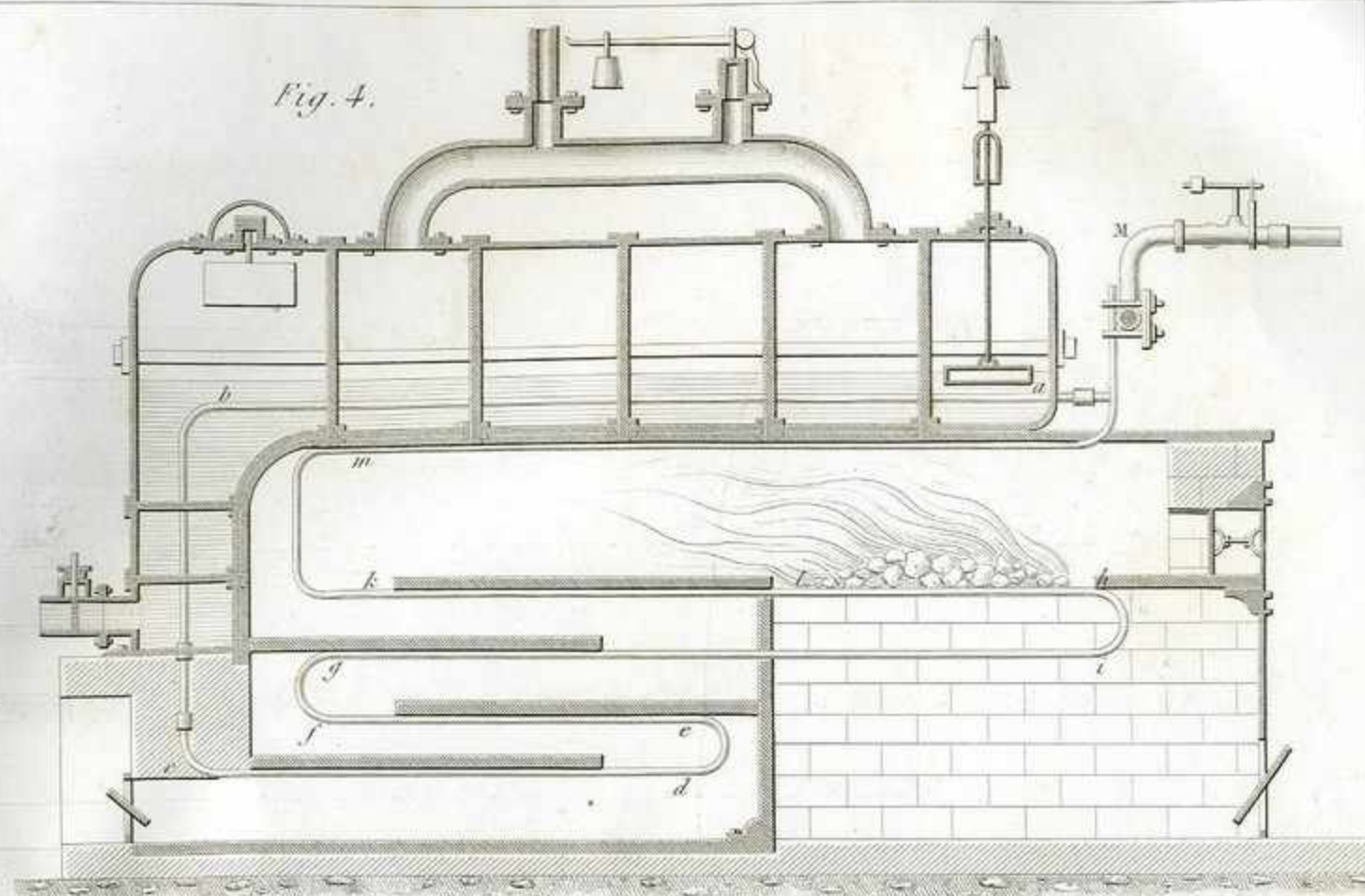
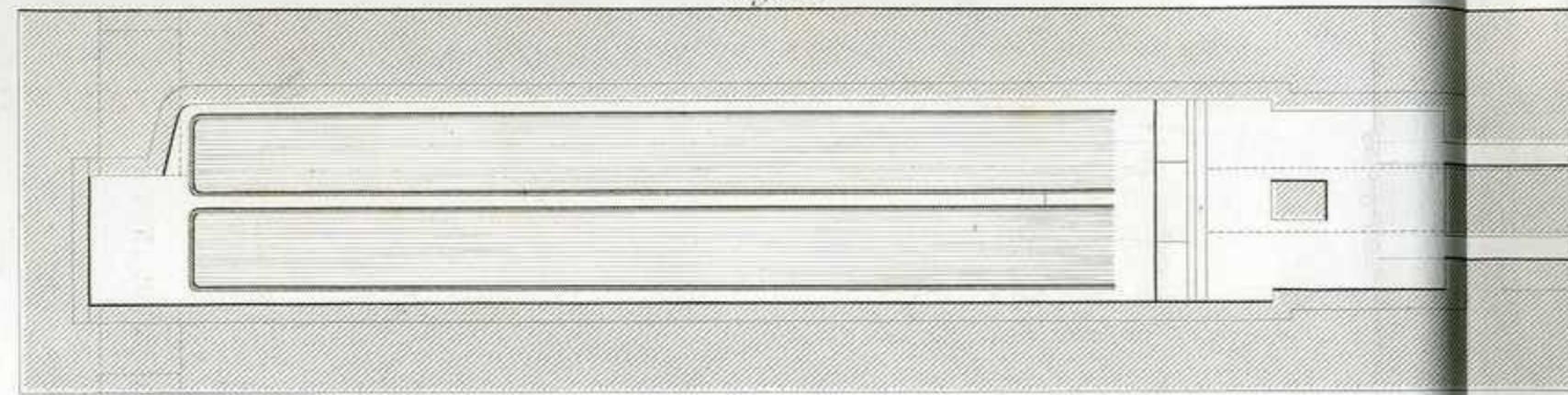


Fig. 4.

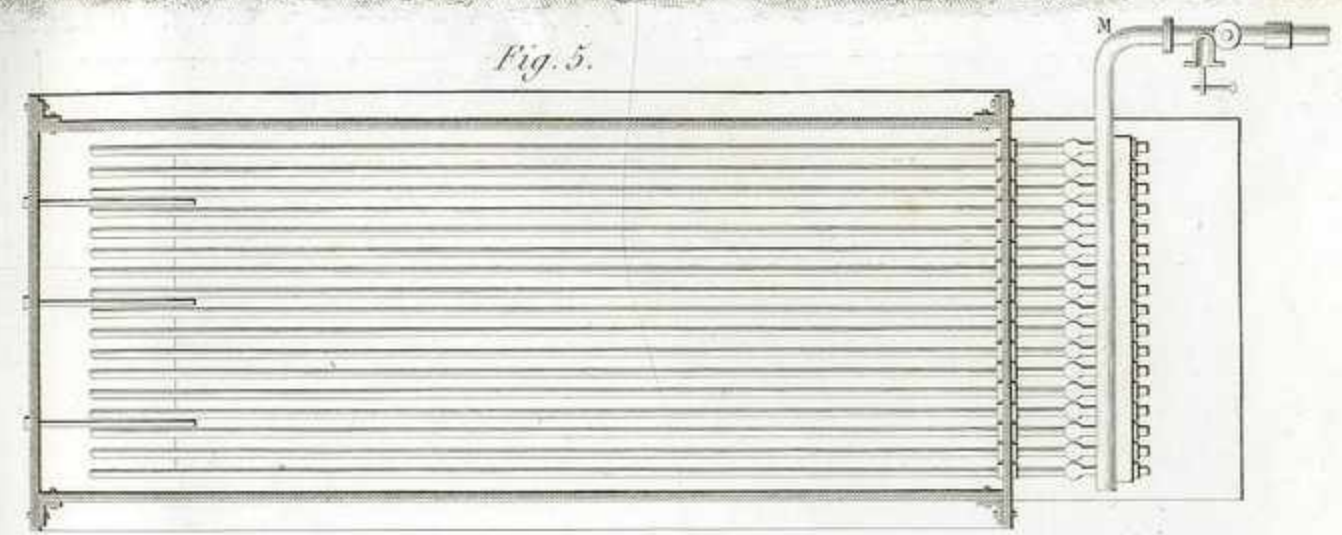


Fig. 5.

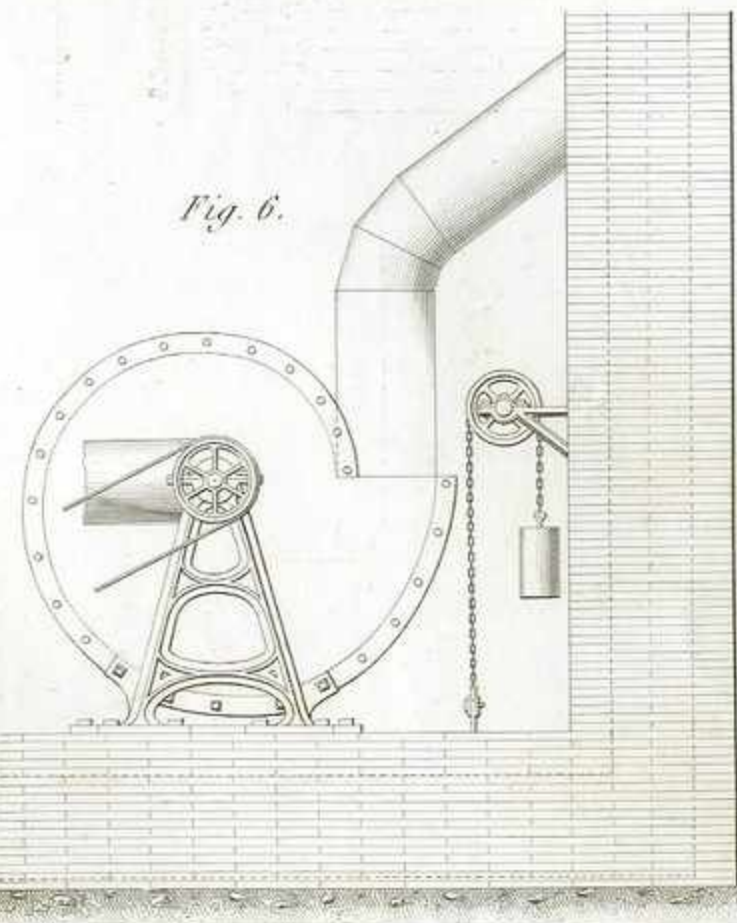


Fig. 6.

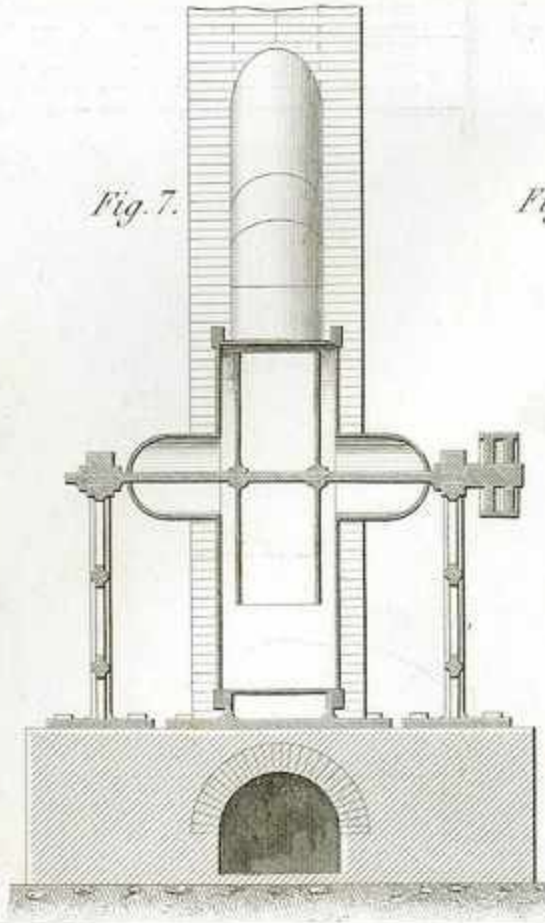


Fig. 7.

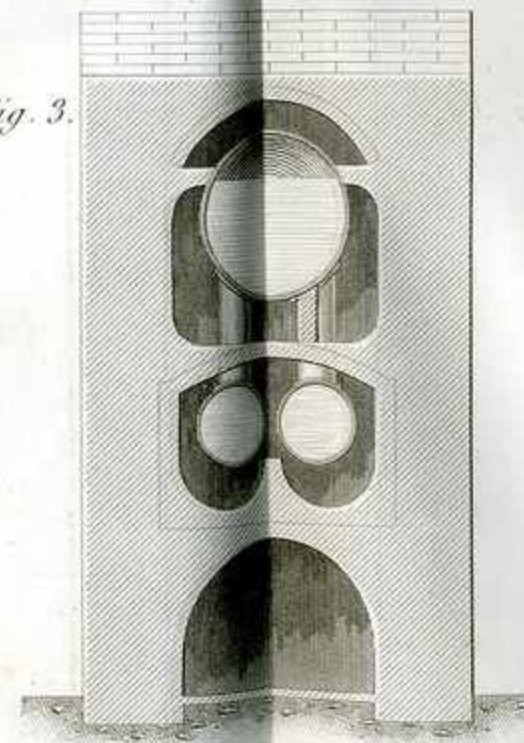


Fig. 3.

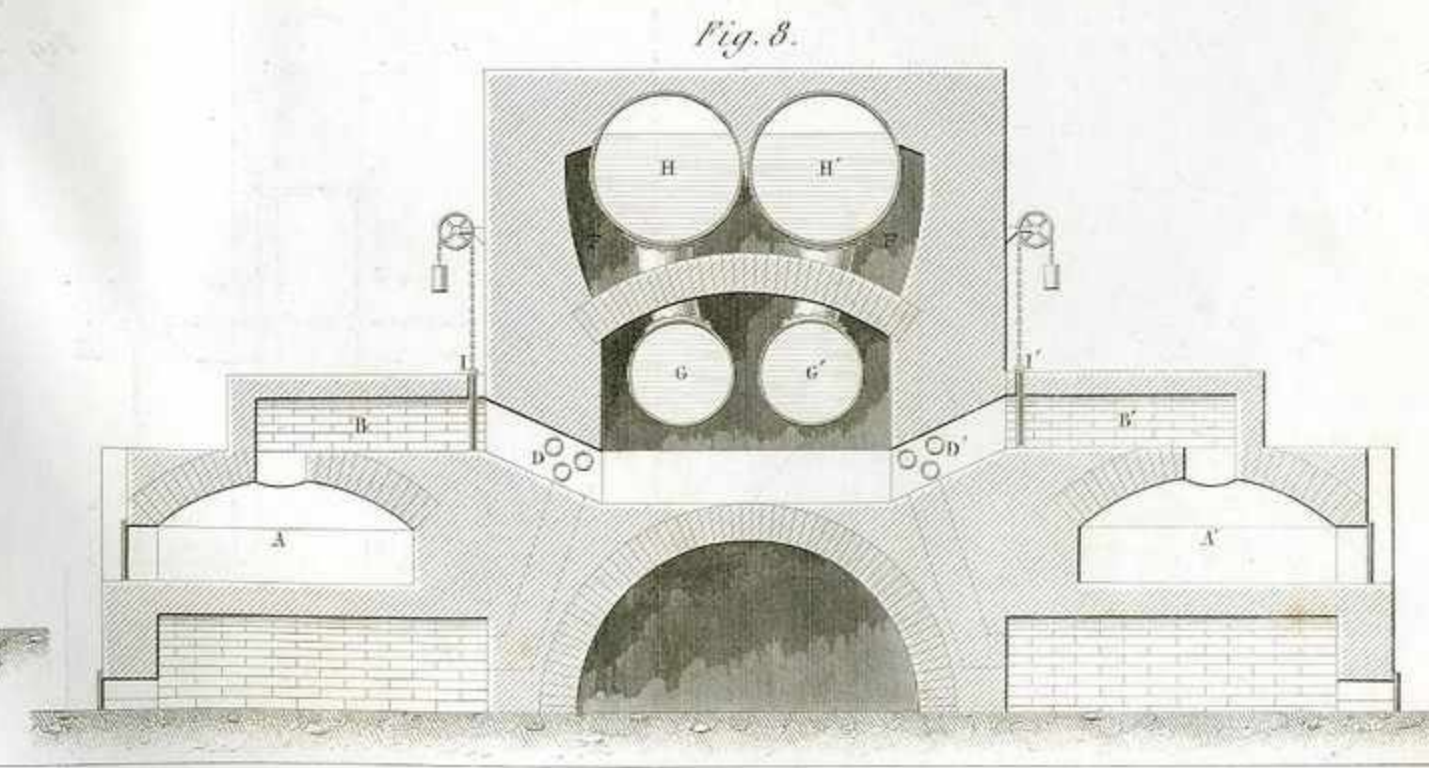
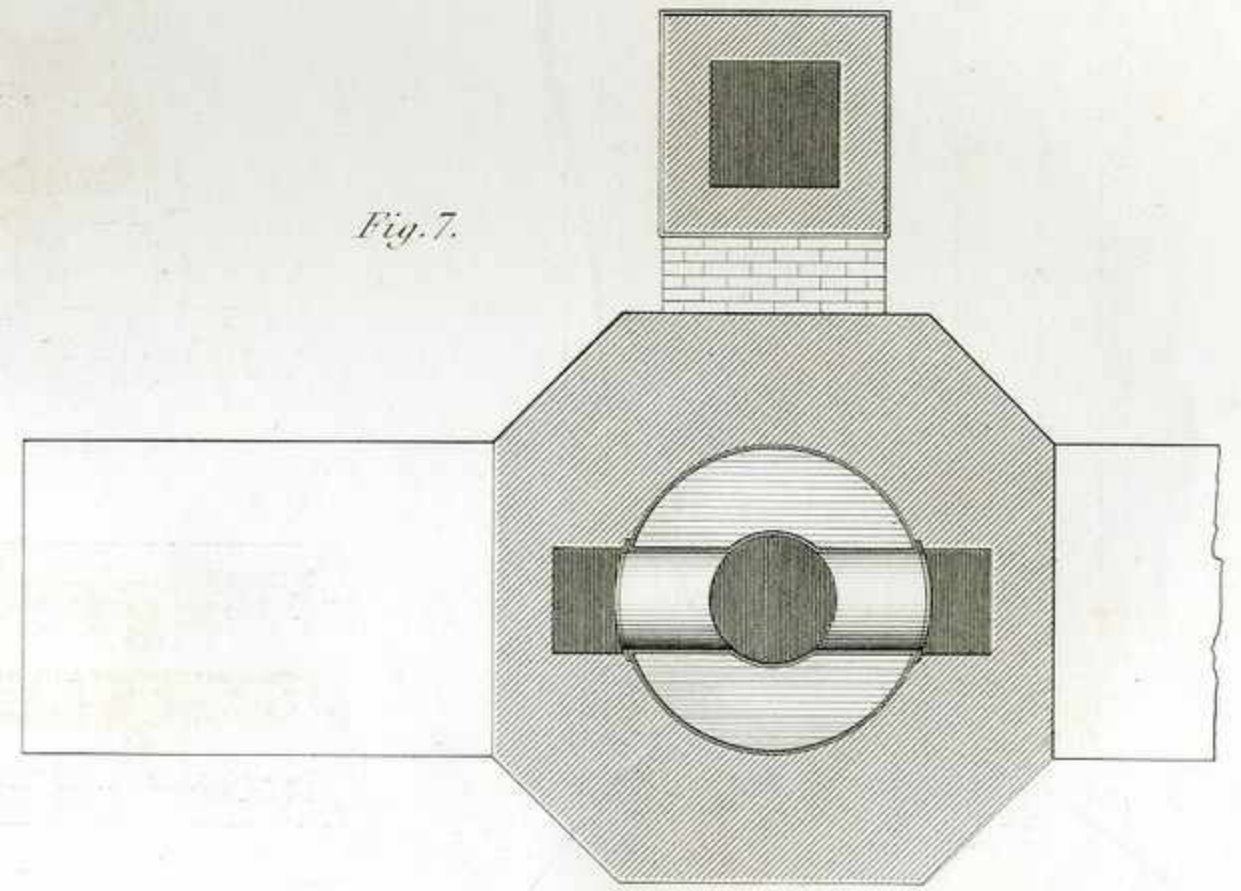
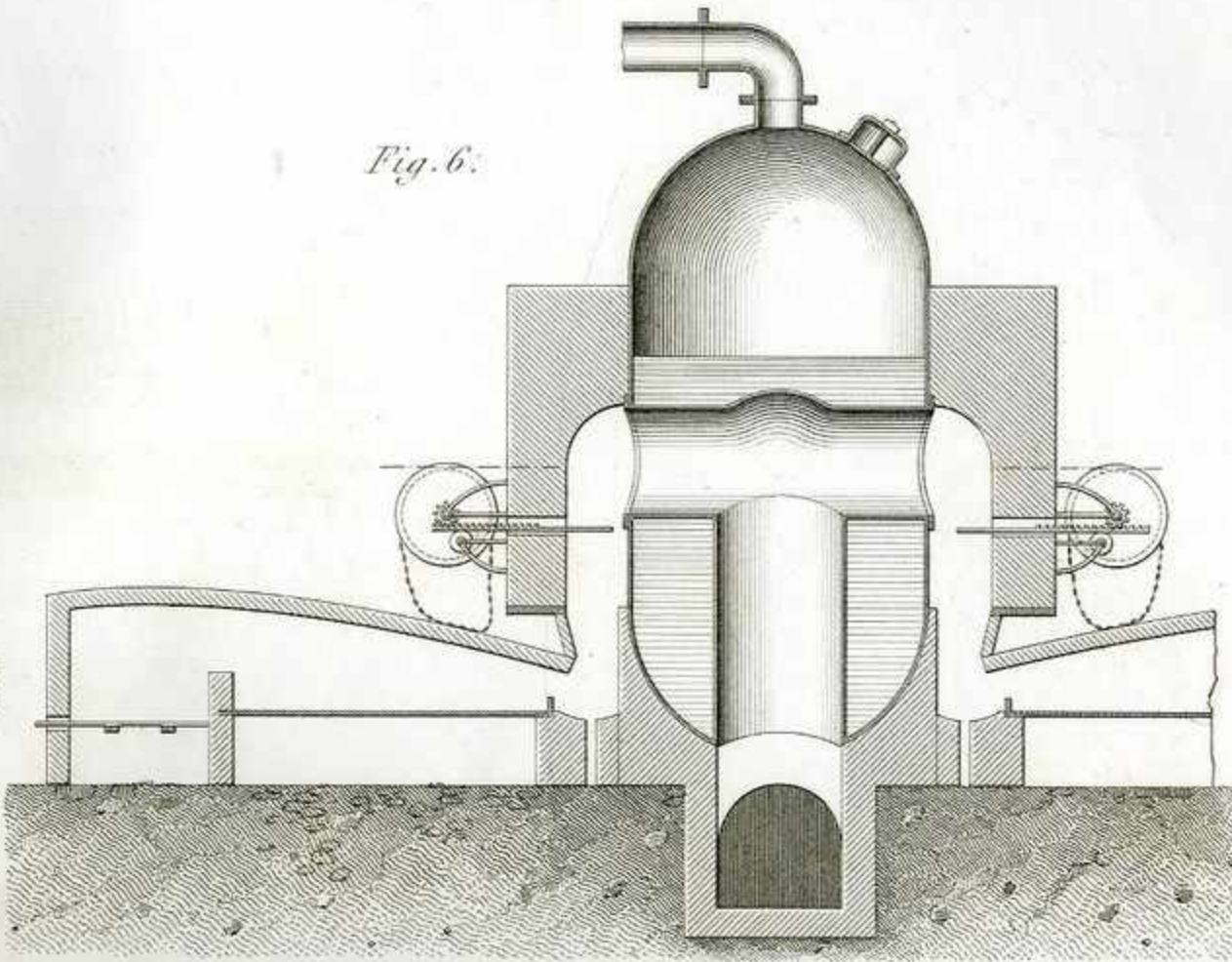
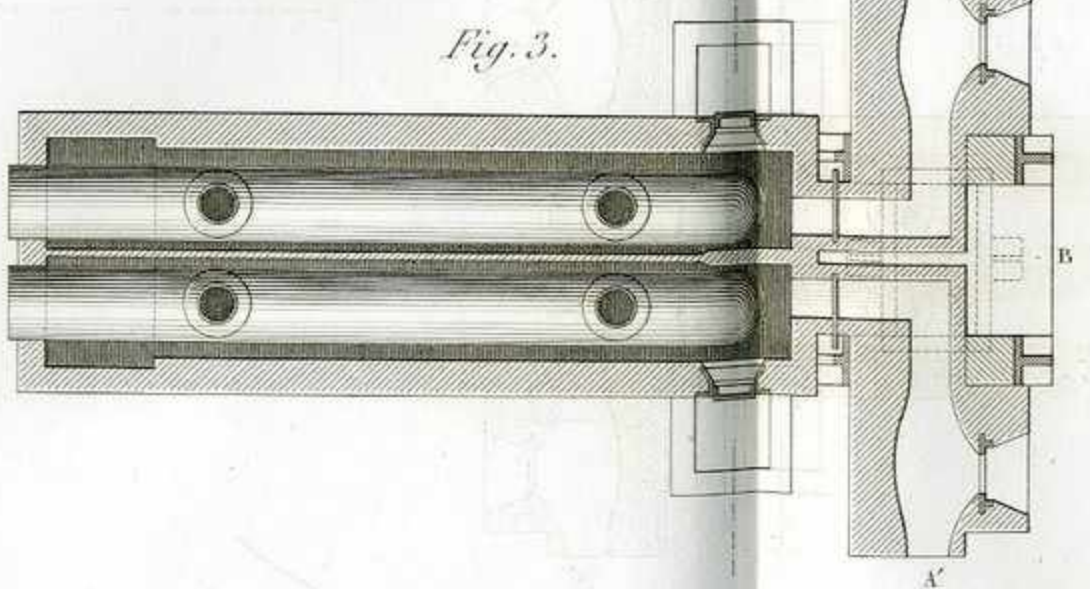
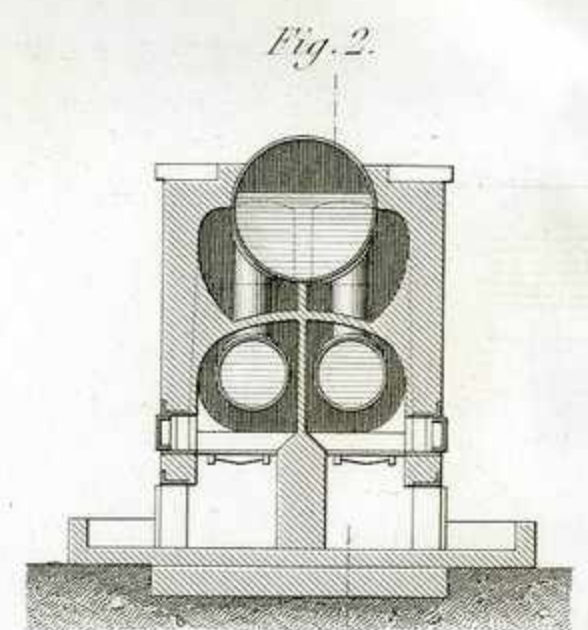
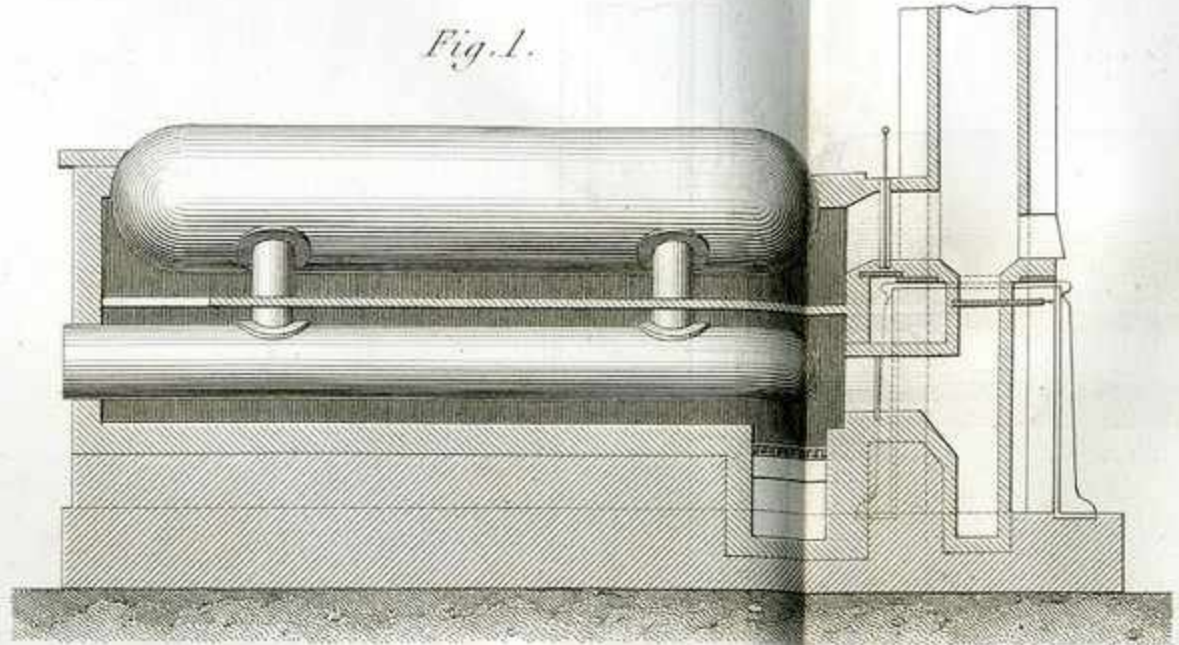
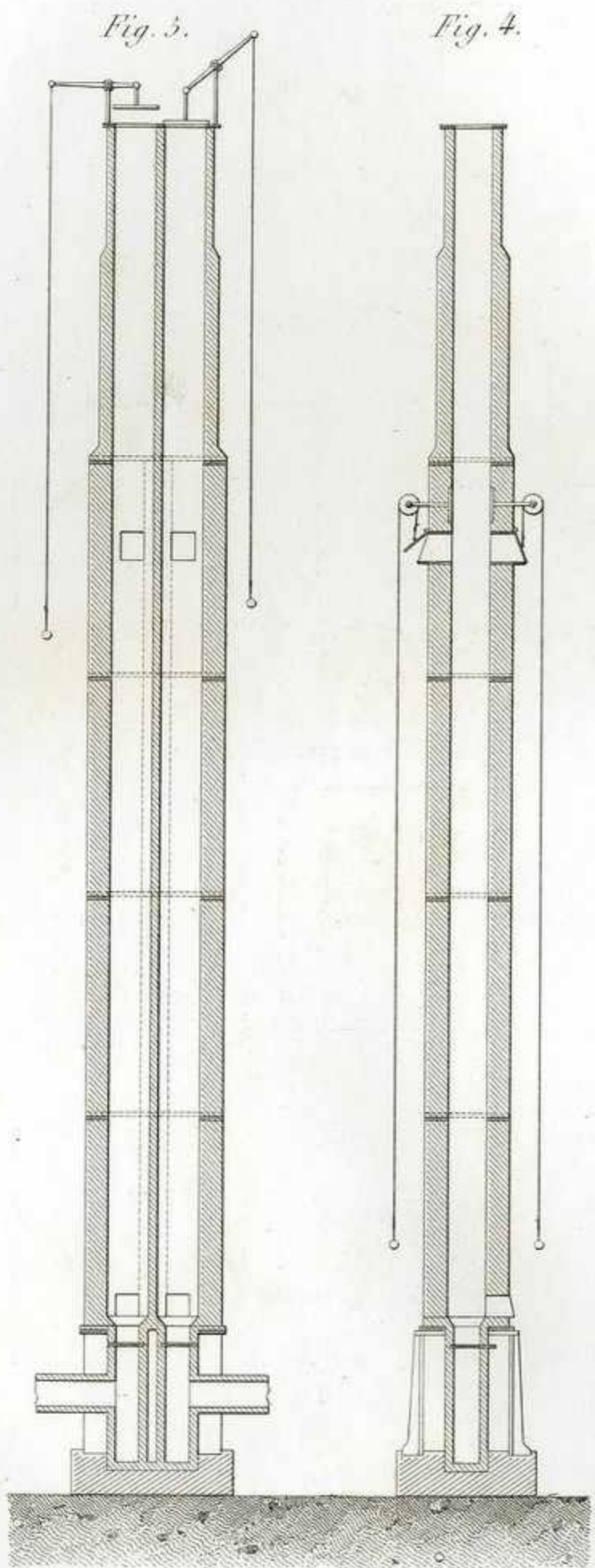
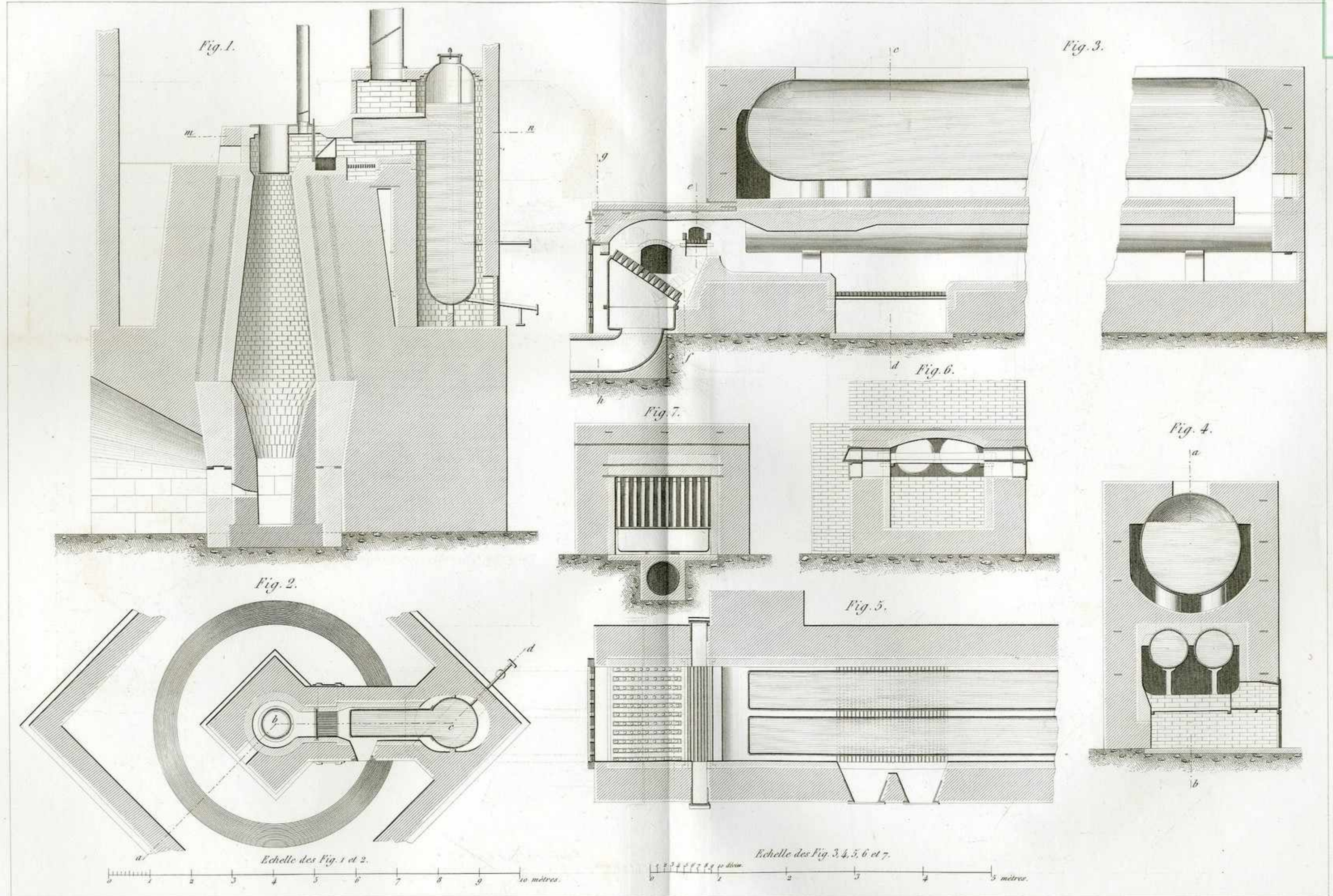
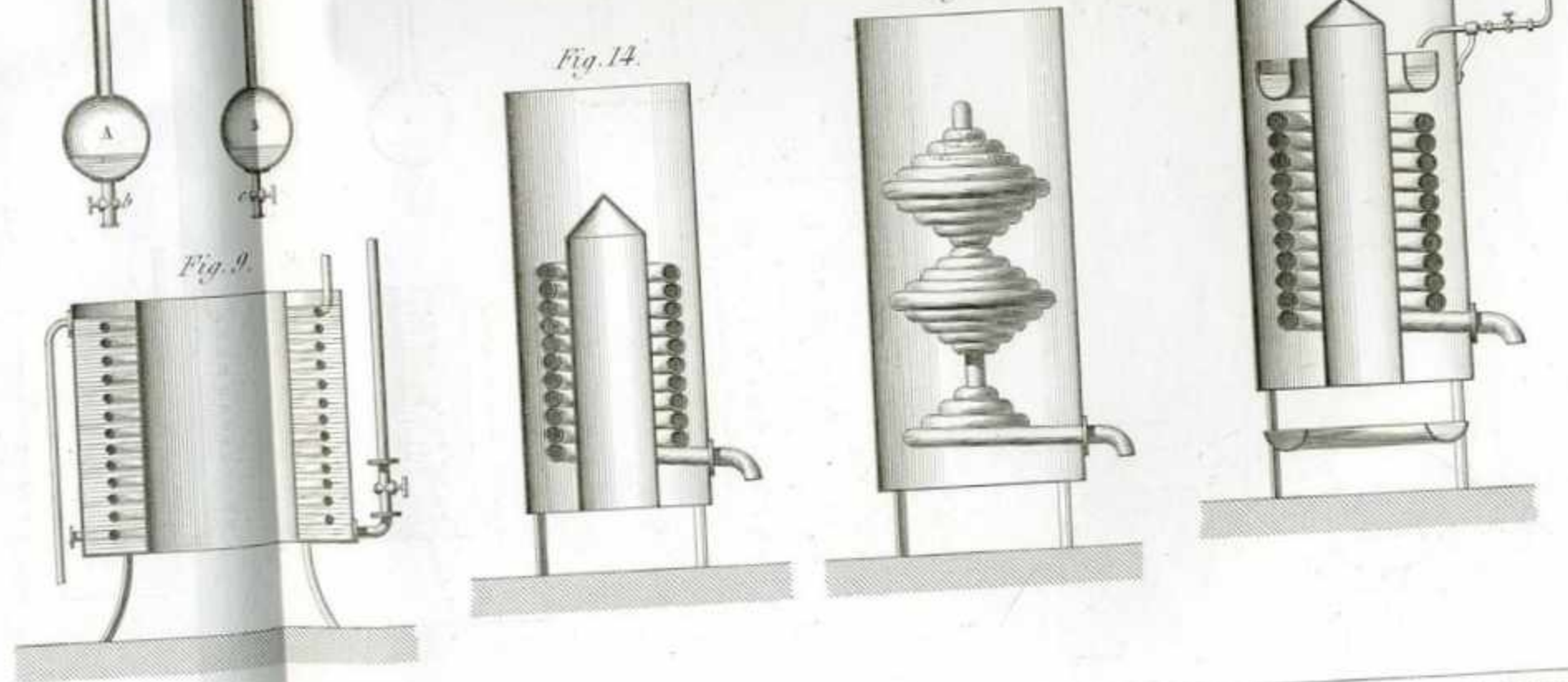
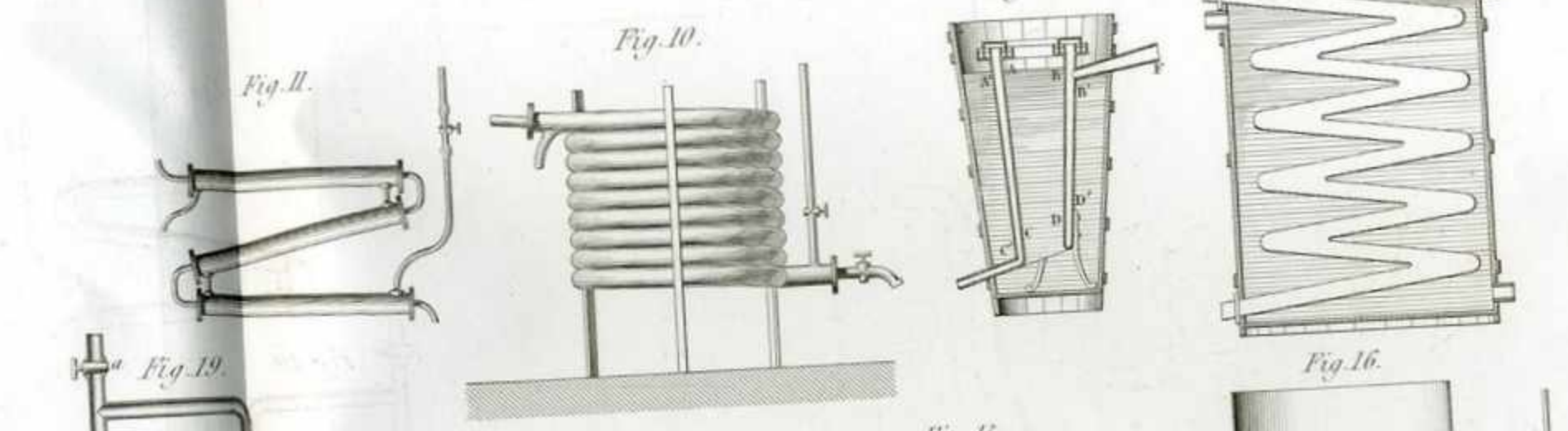
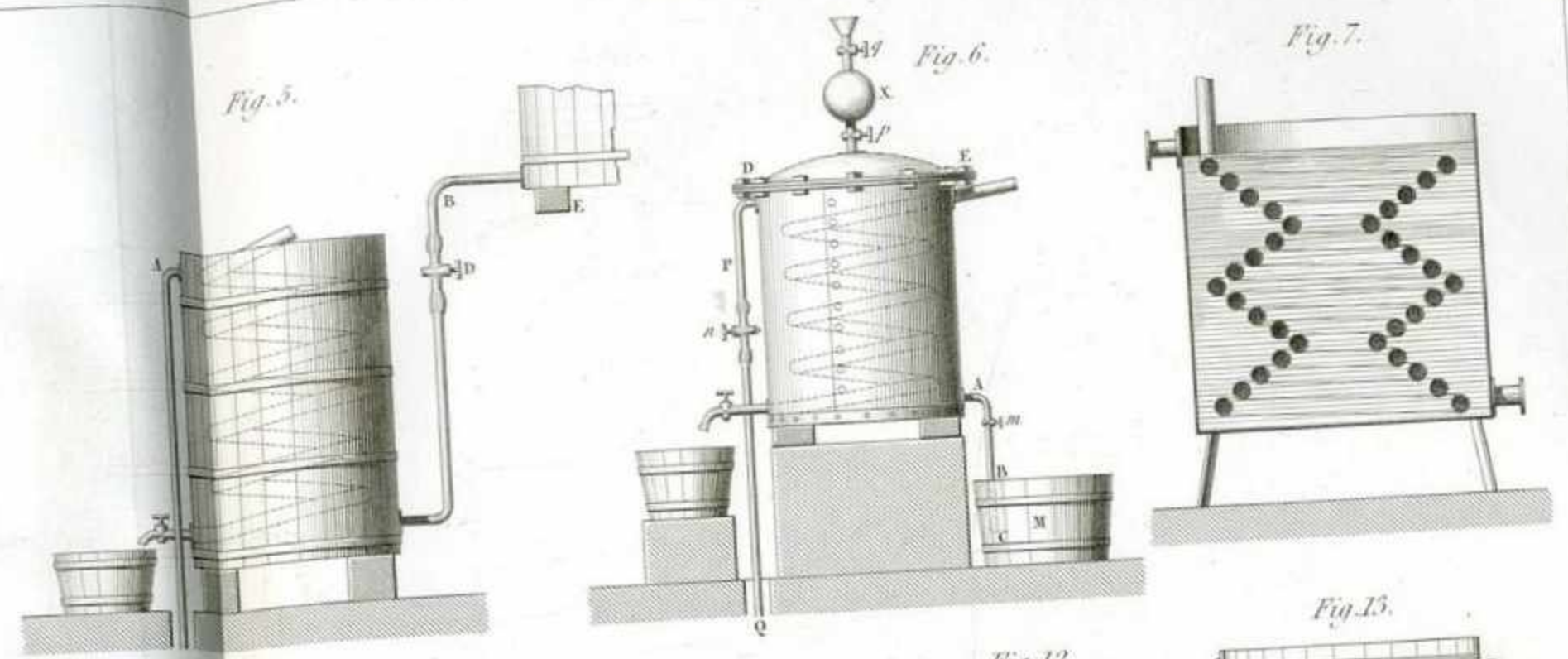
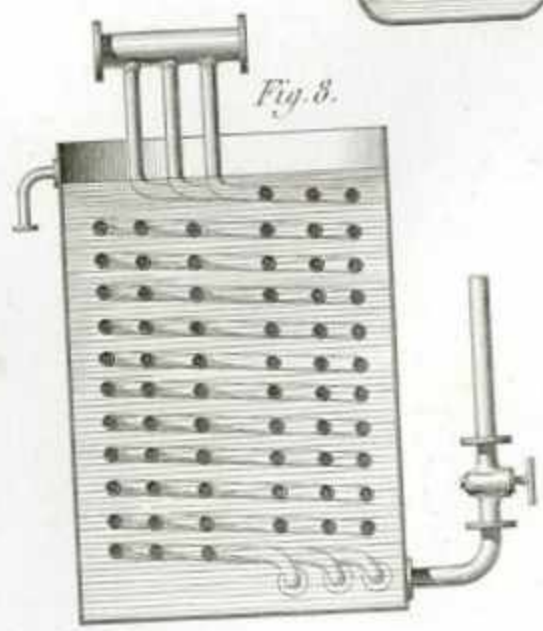
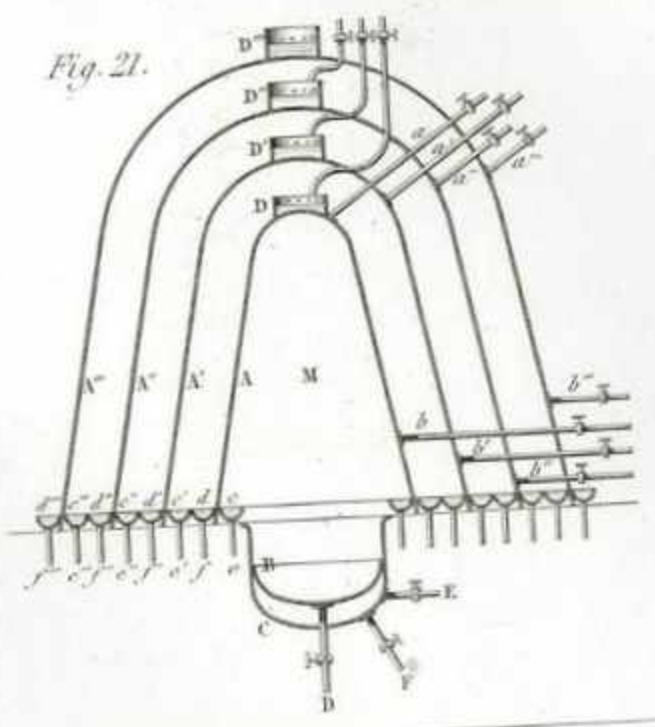
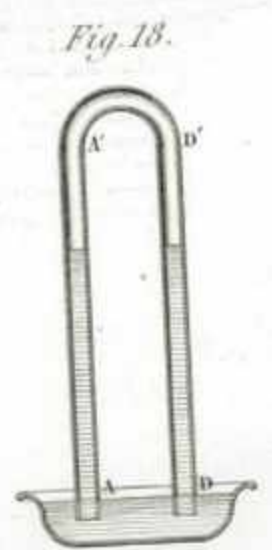
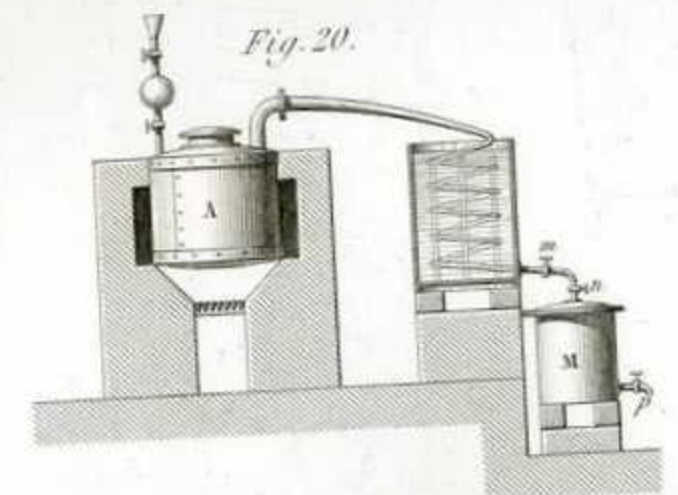
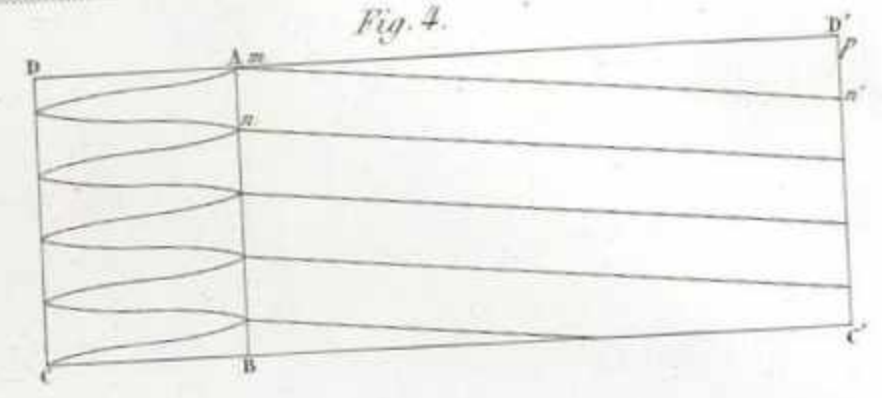
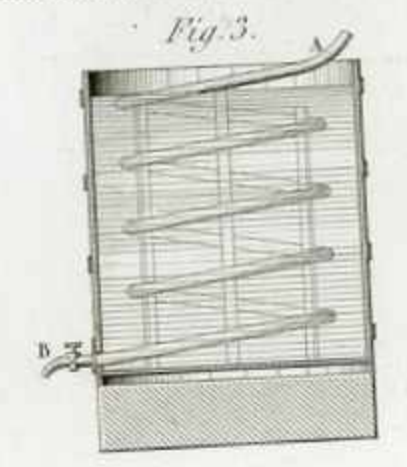
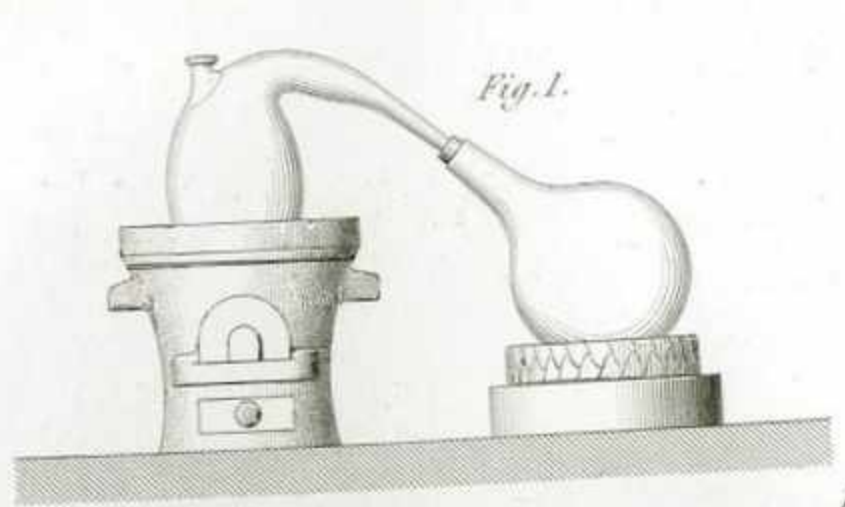


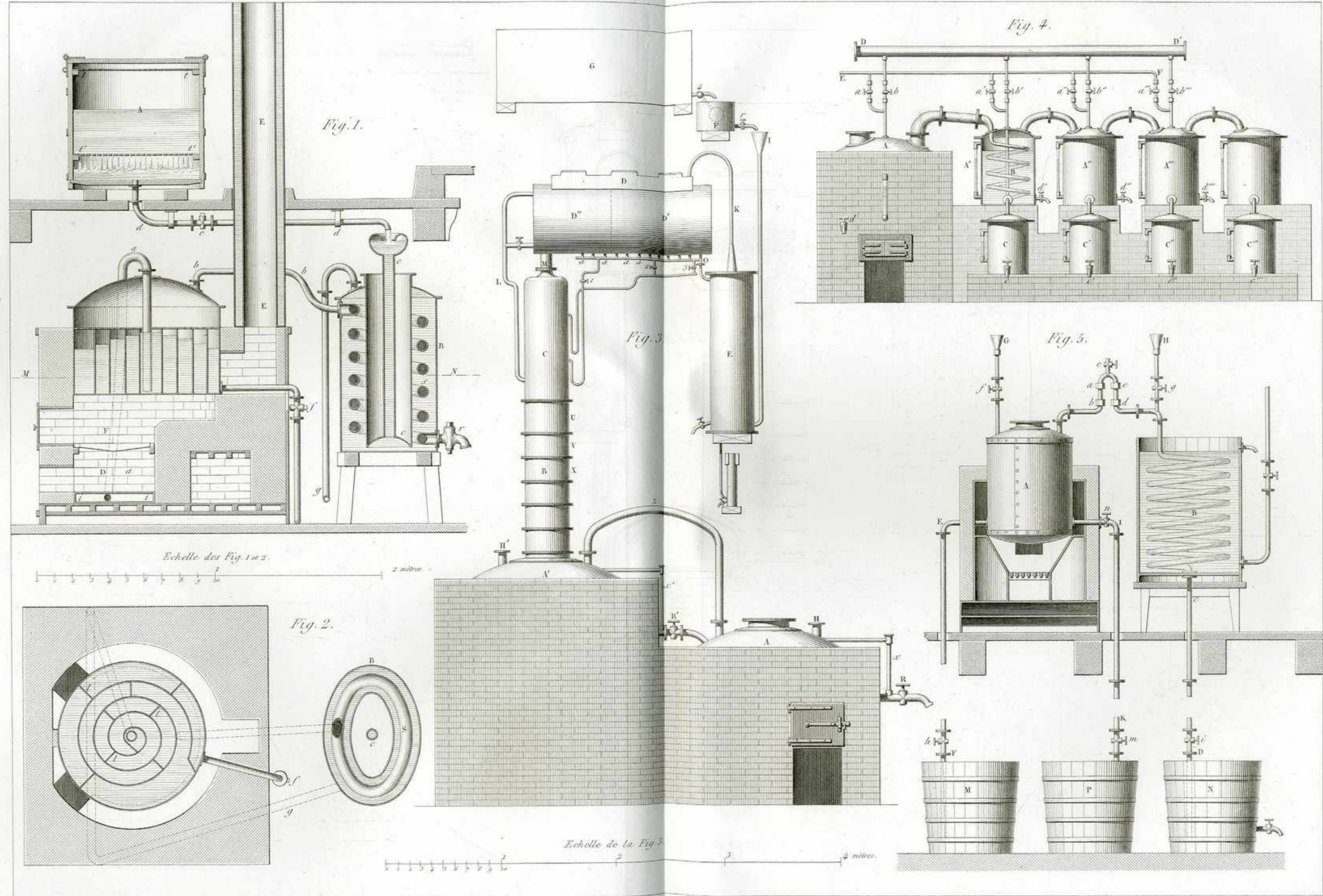
Fig. 8.

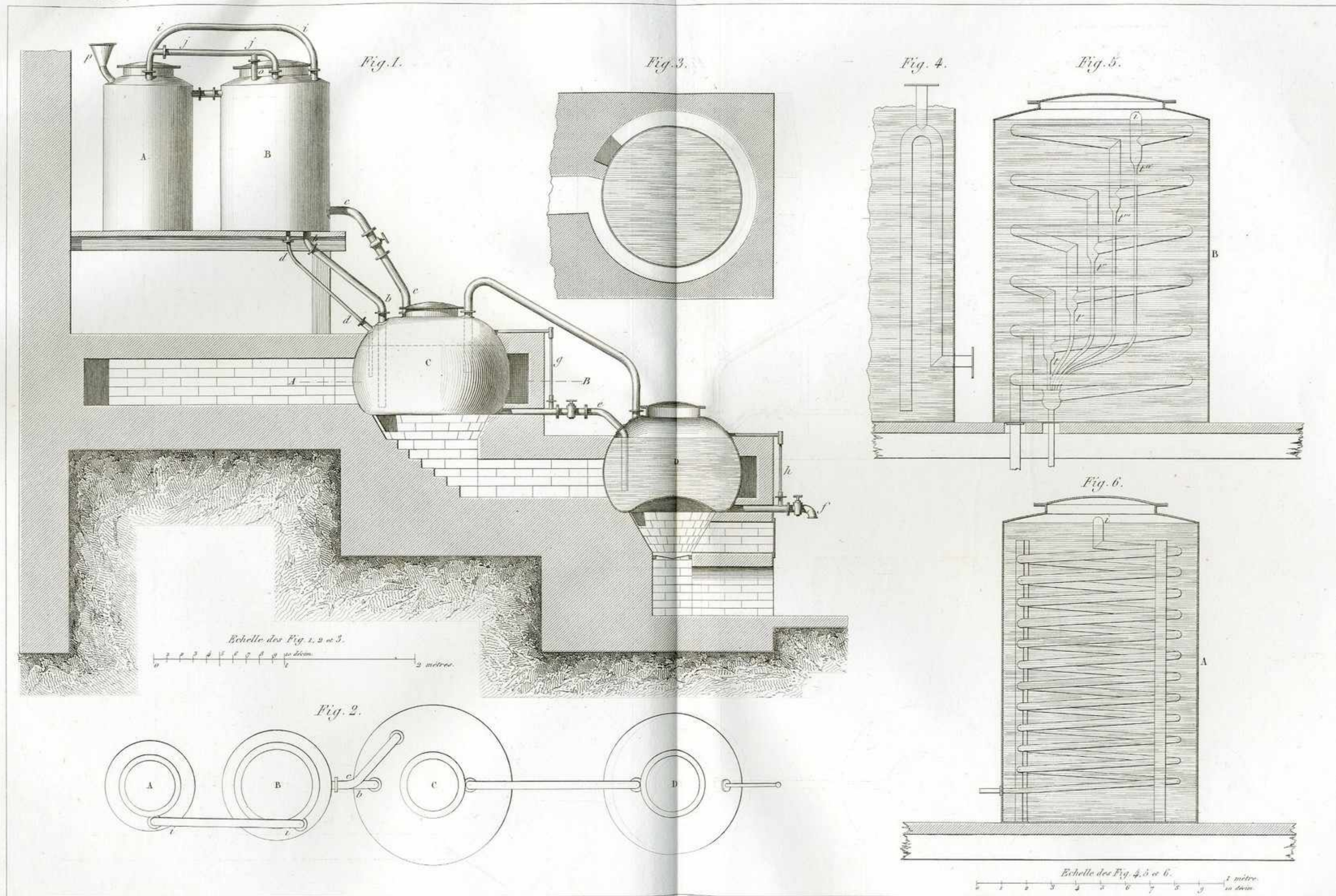


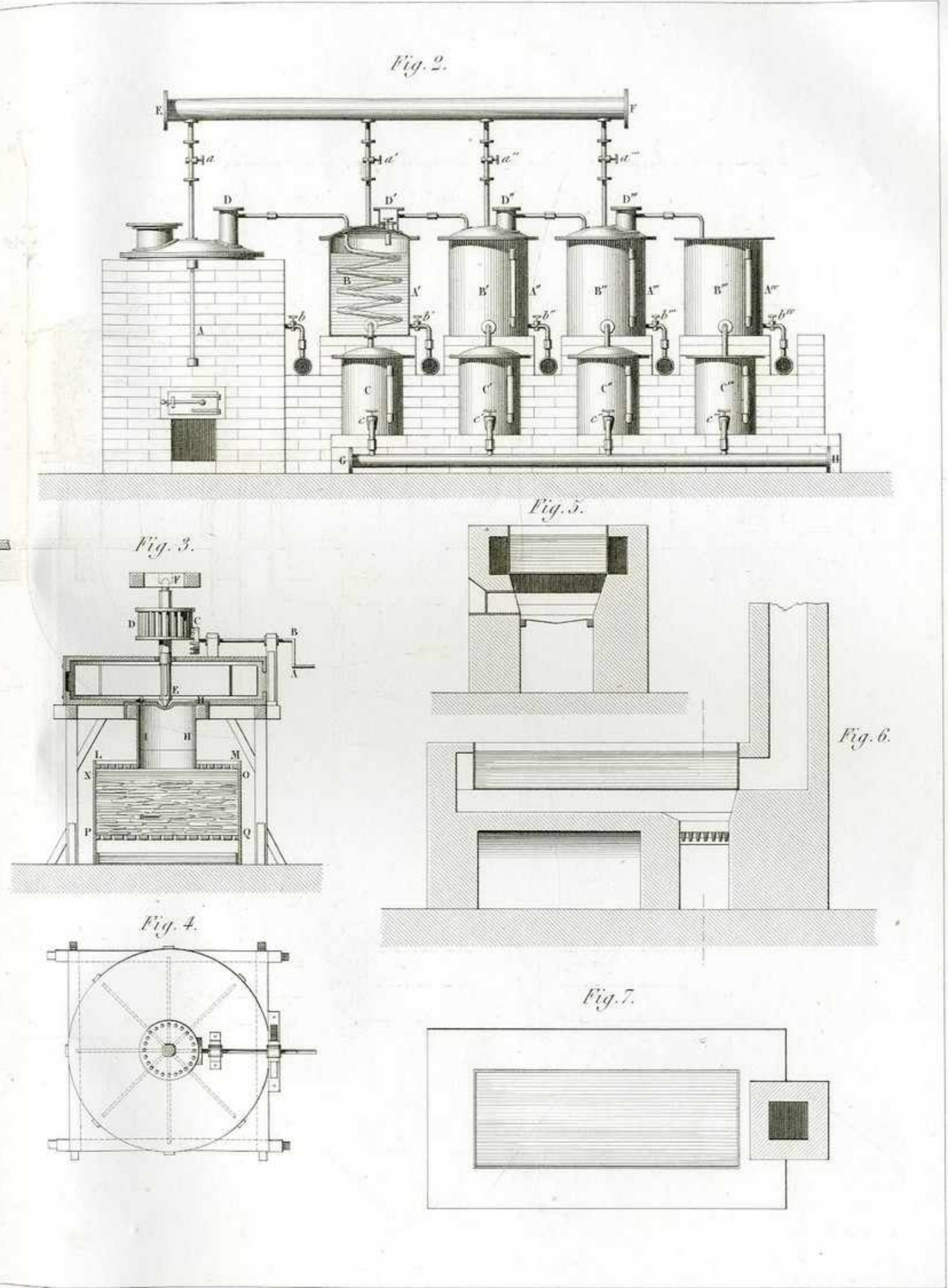
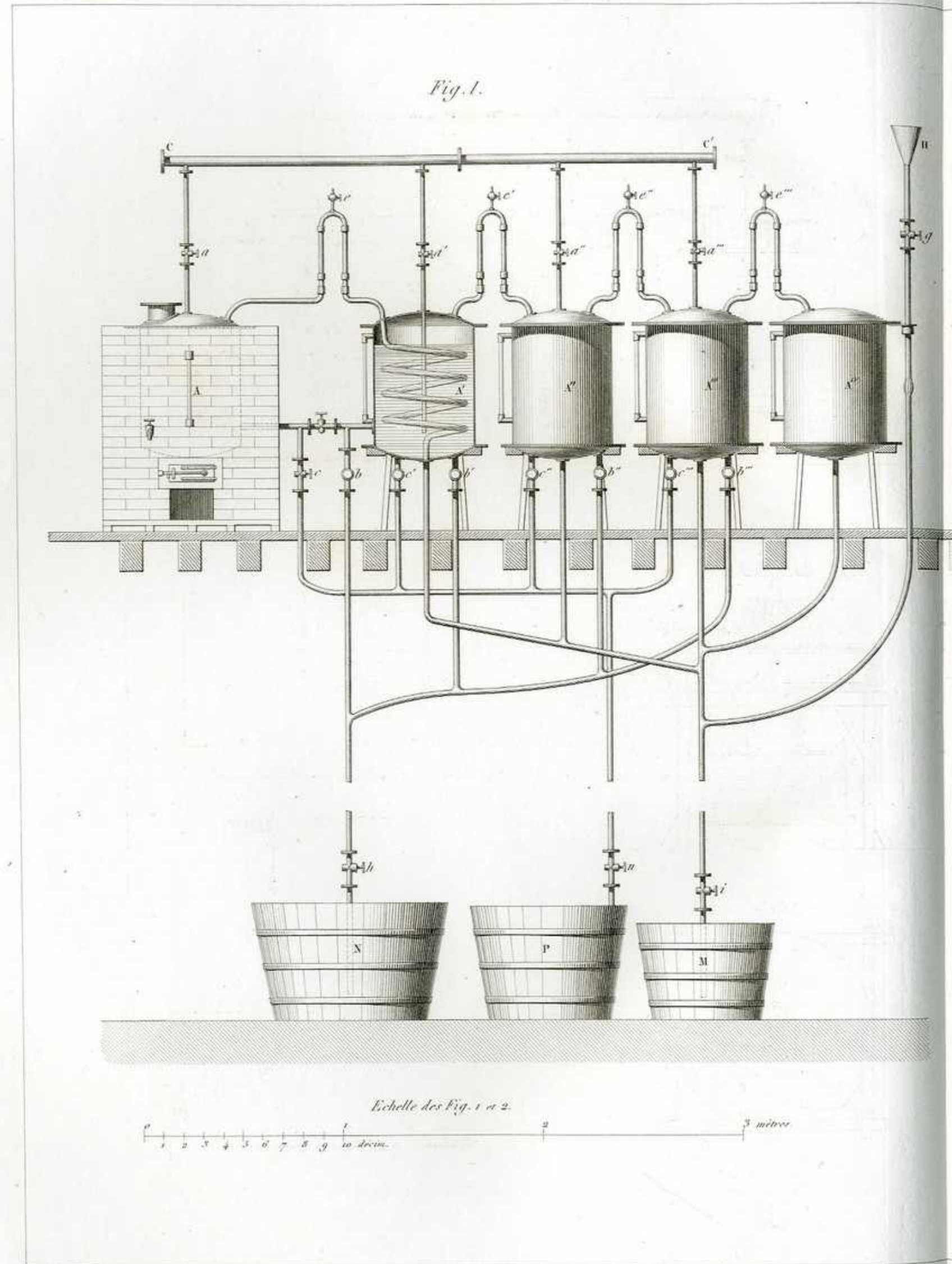
Echelle des Fig. 1, 2, 3, 4 et 5.
0 1 2 3 4 5 6 7 8 9 10 mètres.











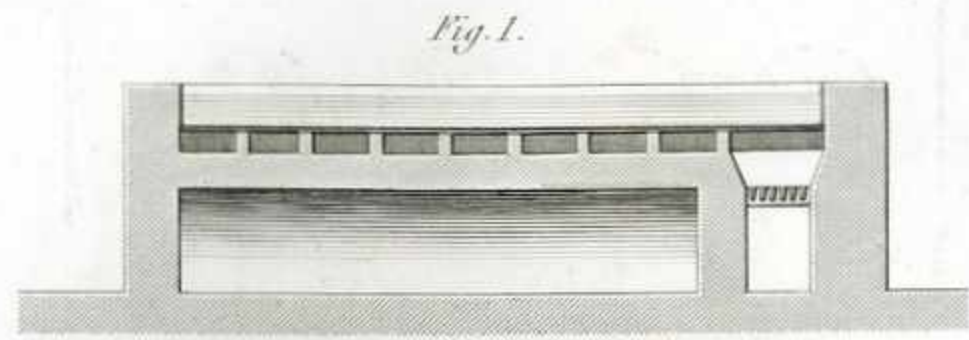


Fig. 1.

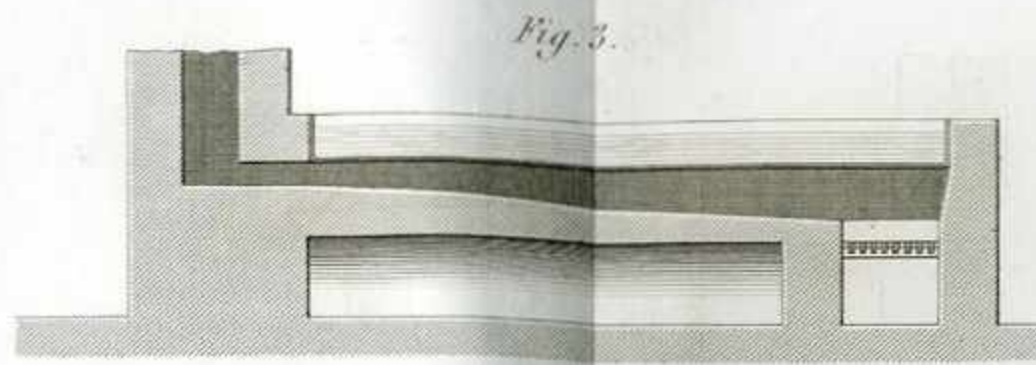


Fig. 3.

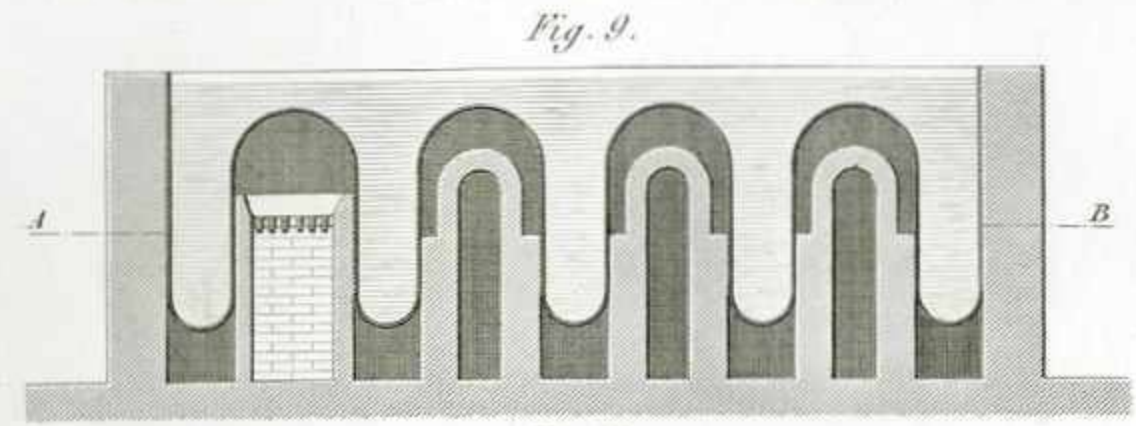


Fig. 9.

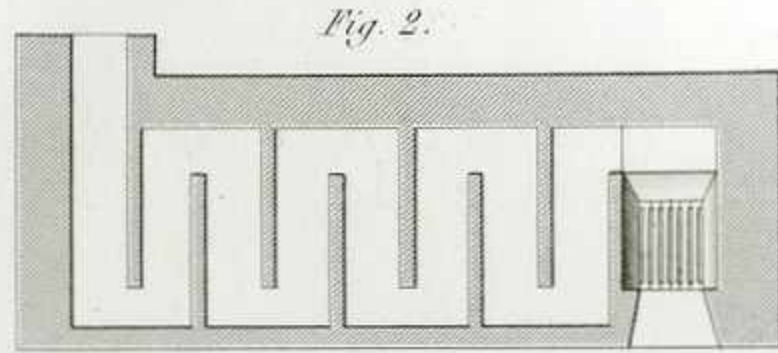


Fig. 2.

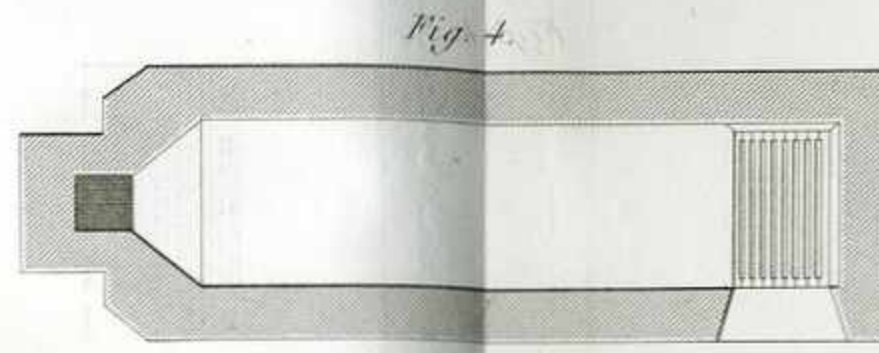


Fig. 4.

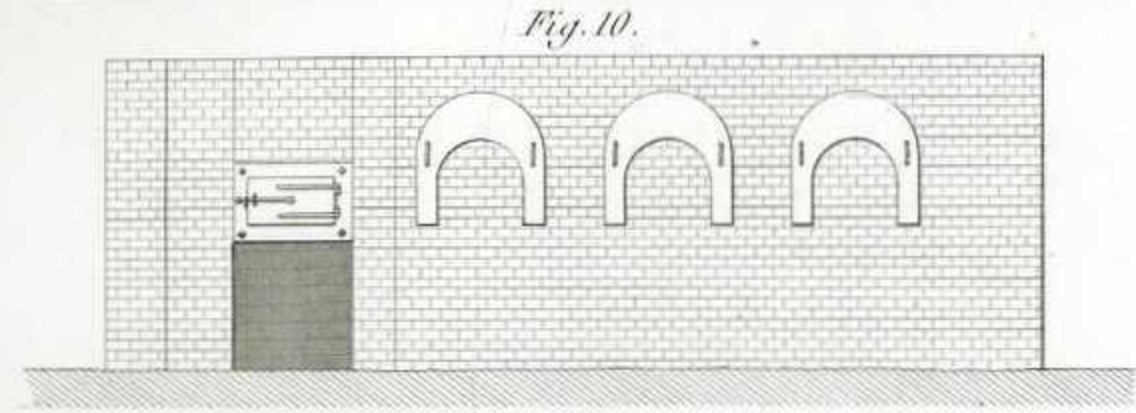


Fig. 10.

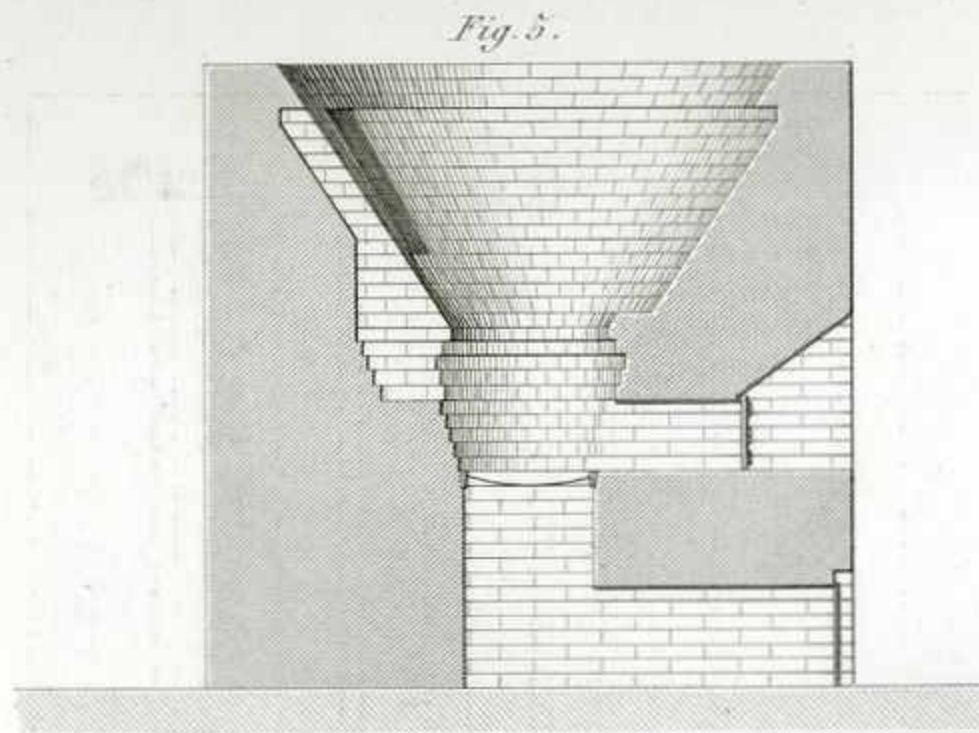


Fig. 5.

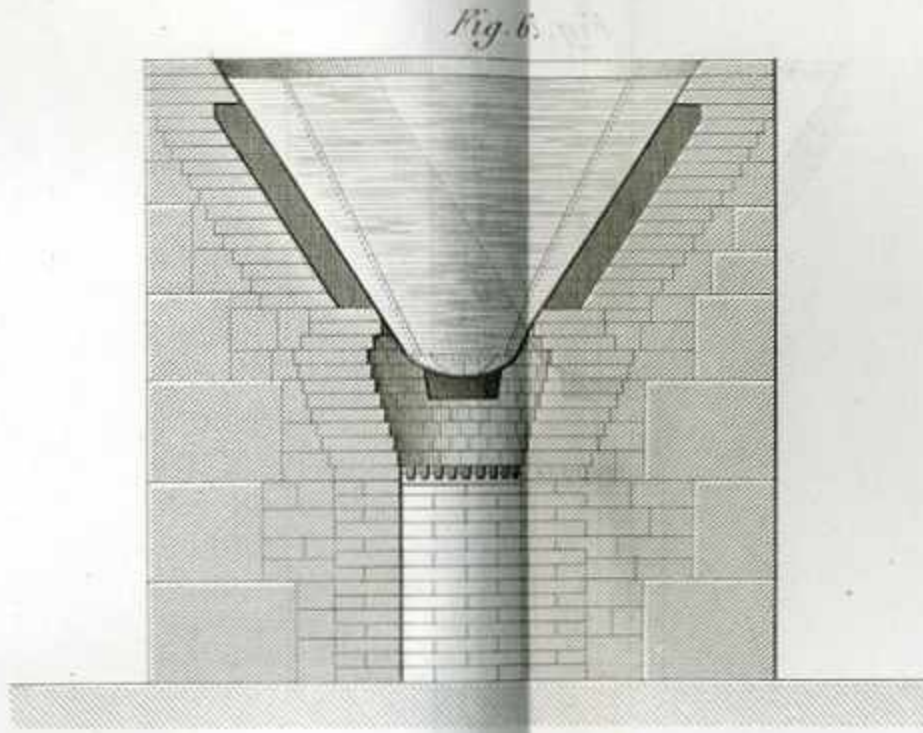


Fig. 6.

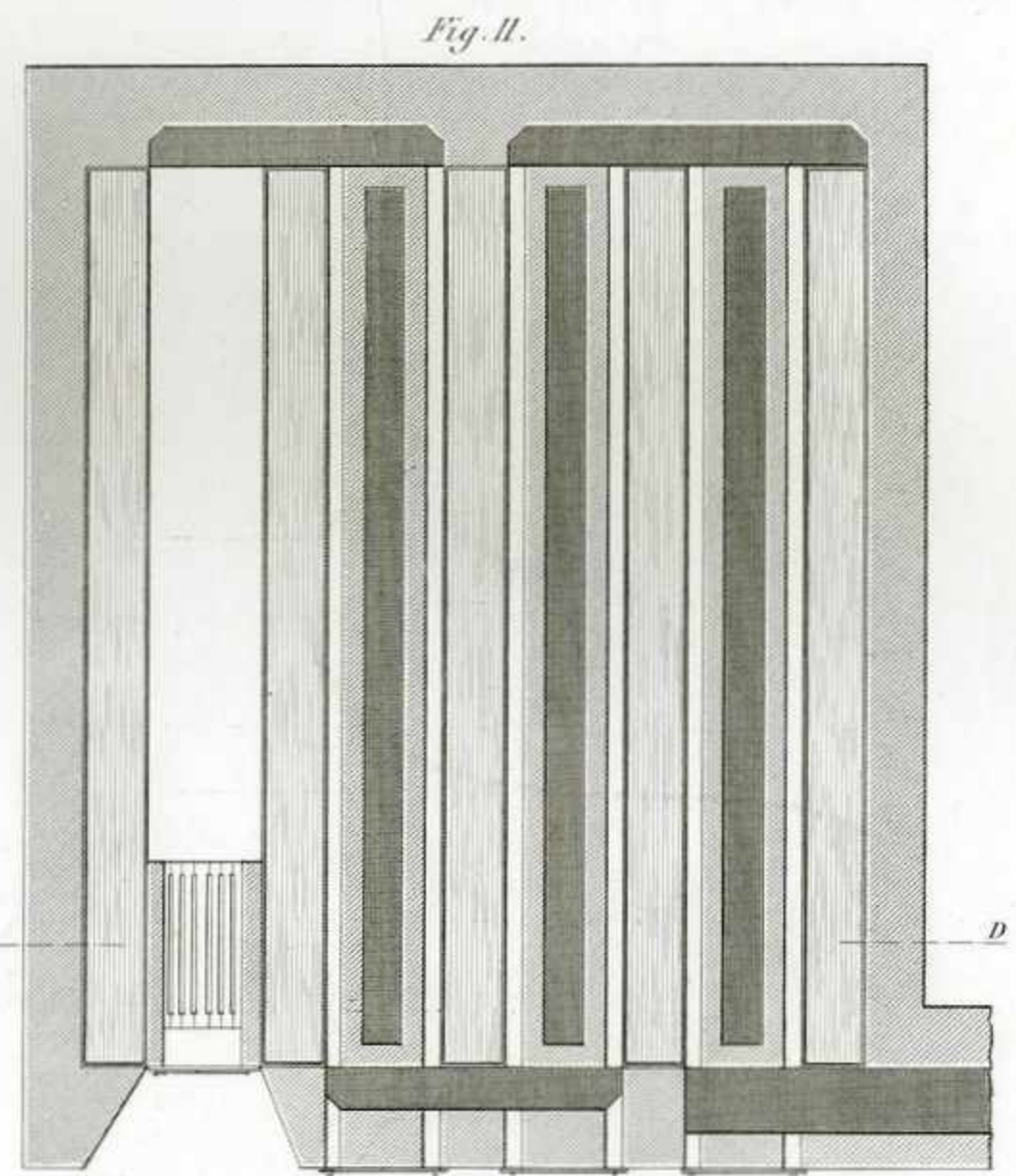


Fig. 11.

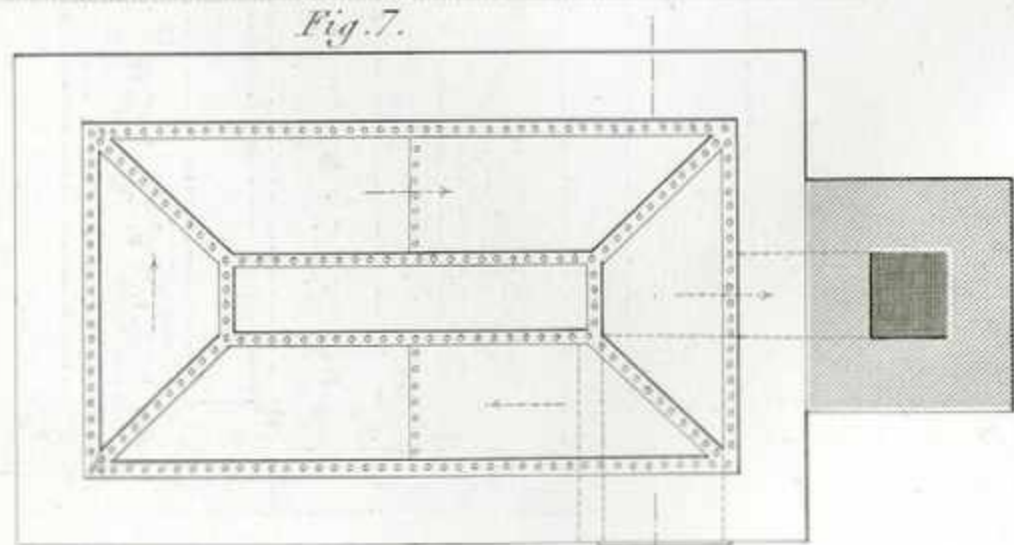


Fig. 7.

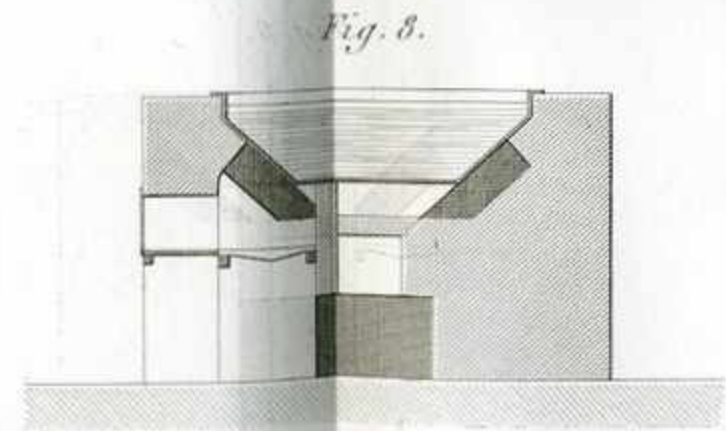
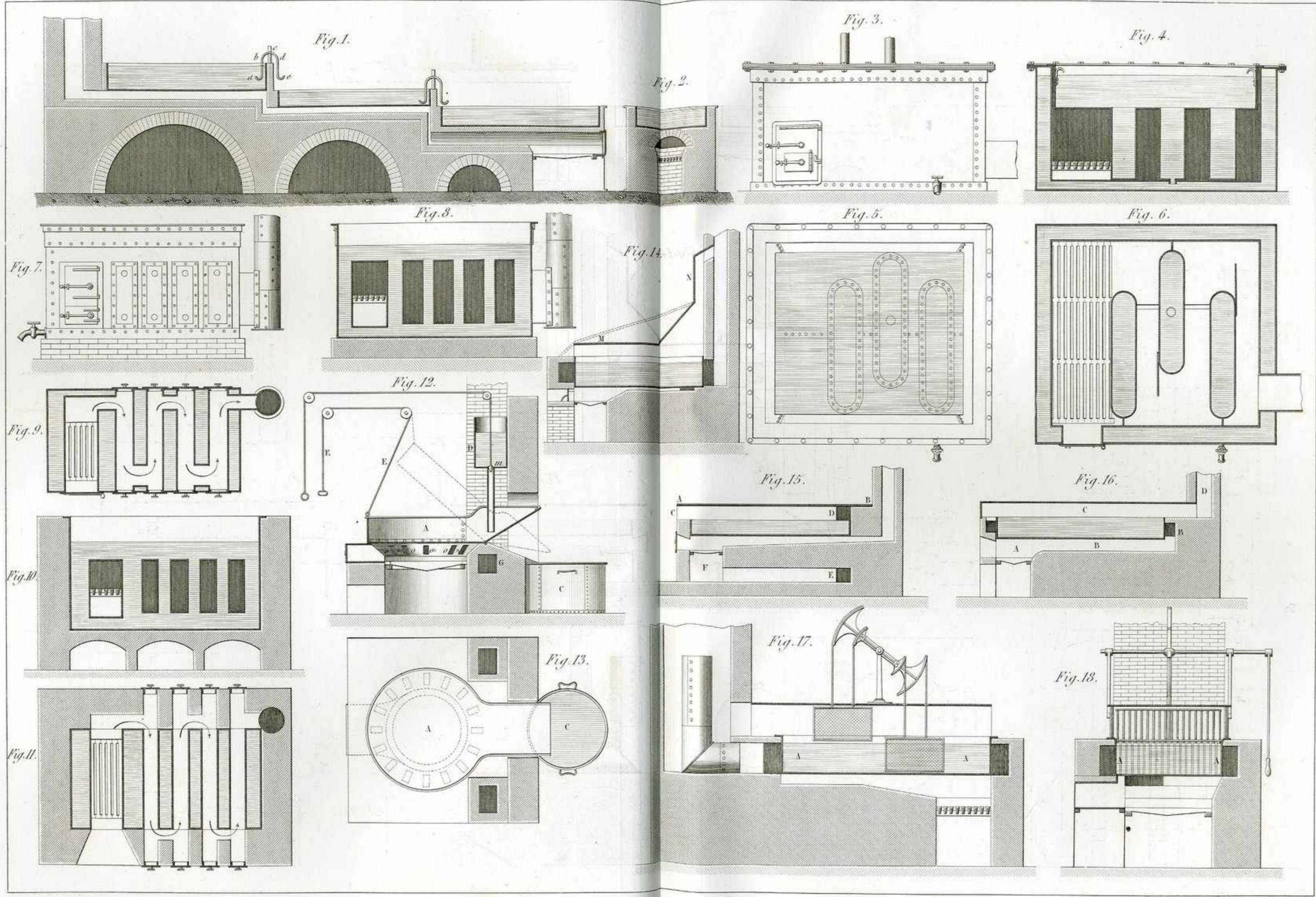
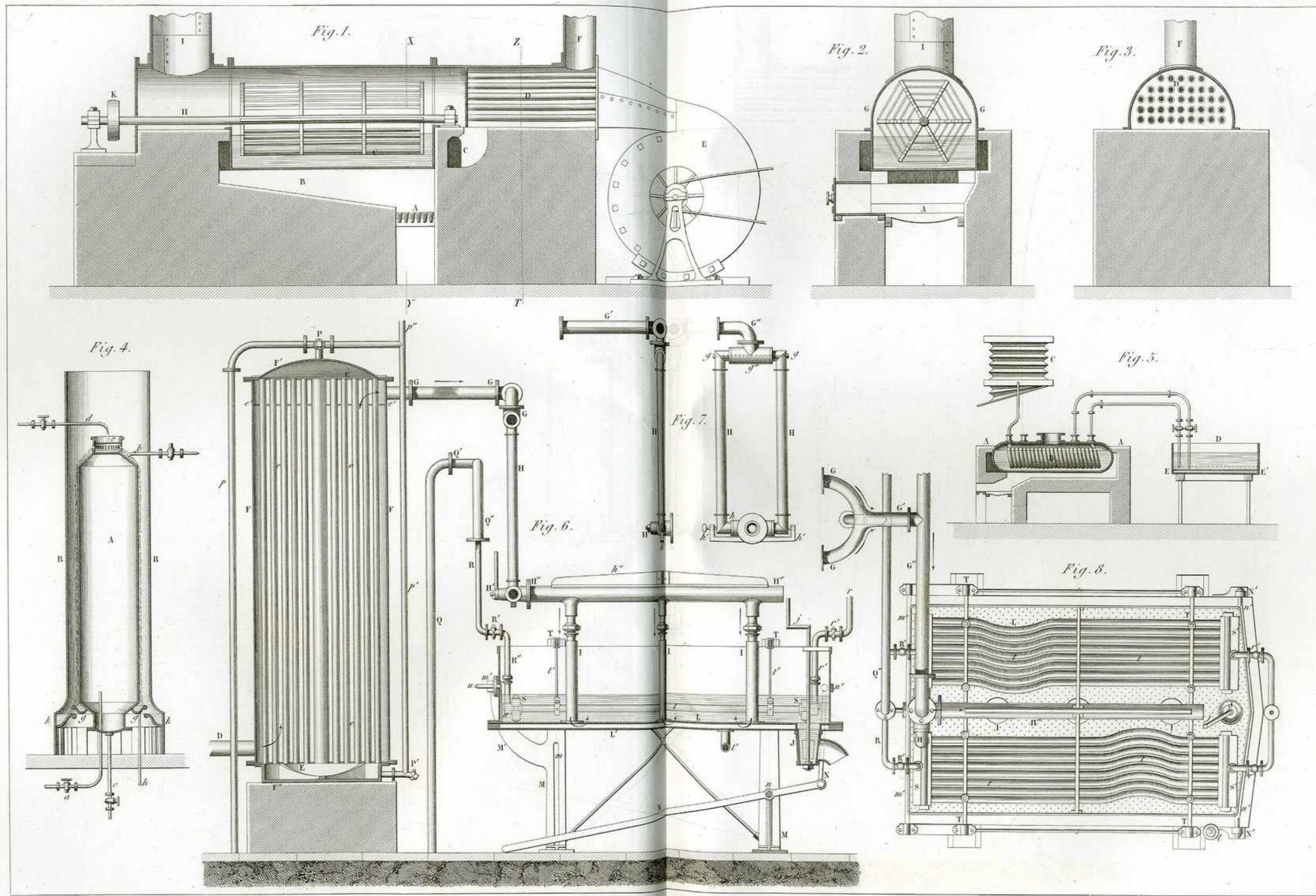


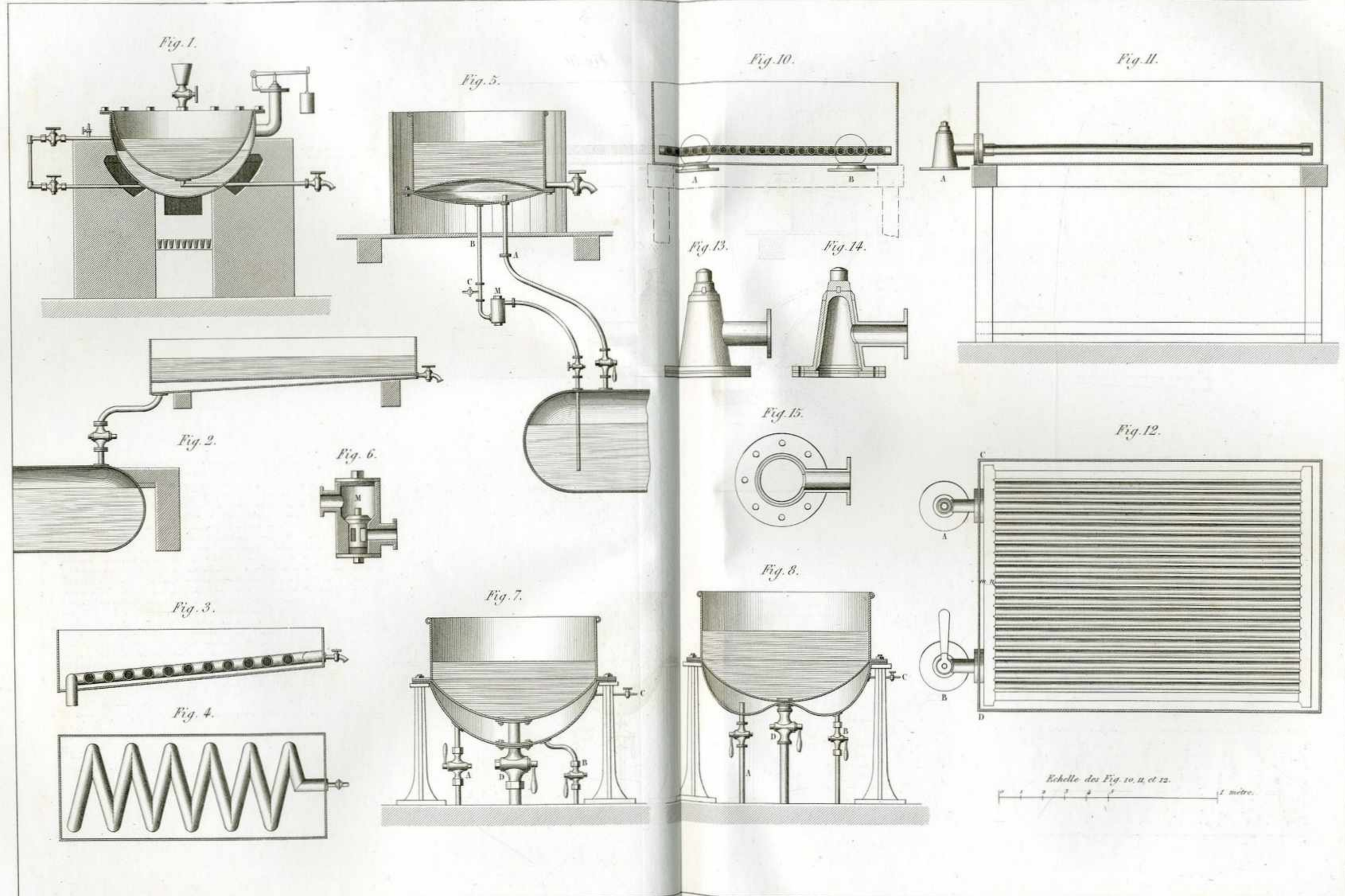
Fig. 8.

Echelle des Fig. 5 et 6.
0 1 2 3 4 5 6 7 8 9 10
10 décim.
2 mètres.

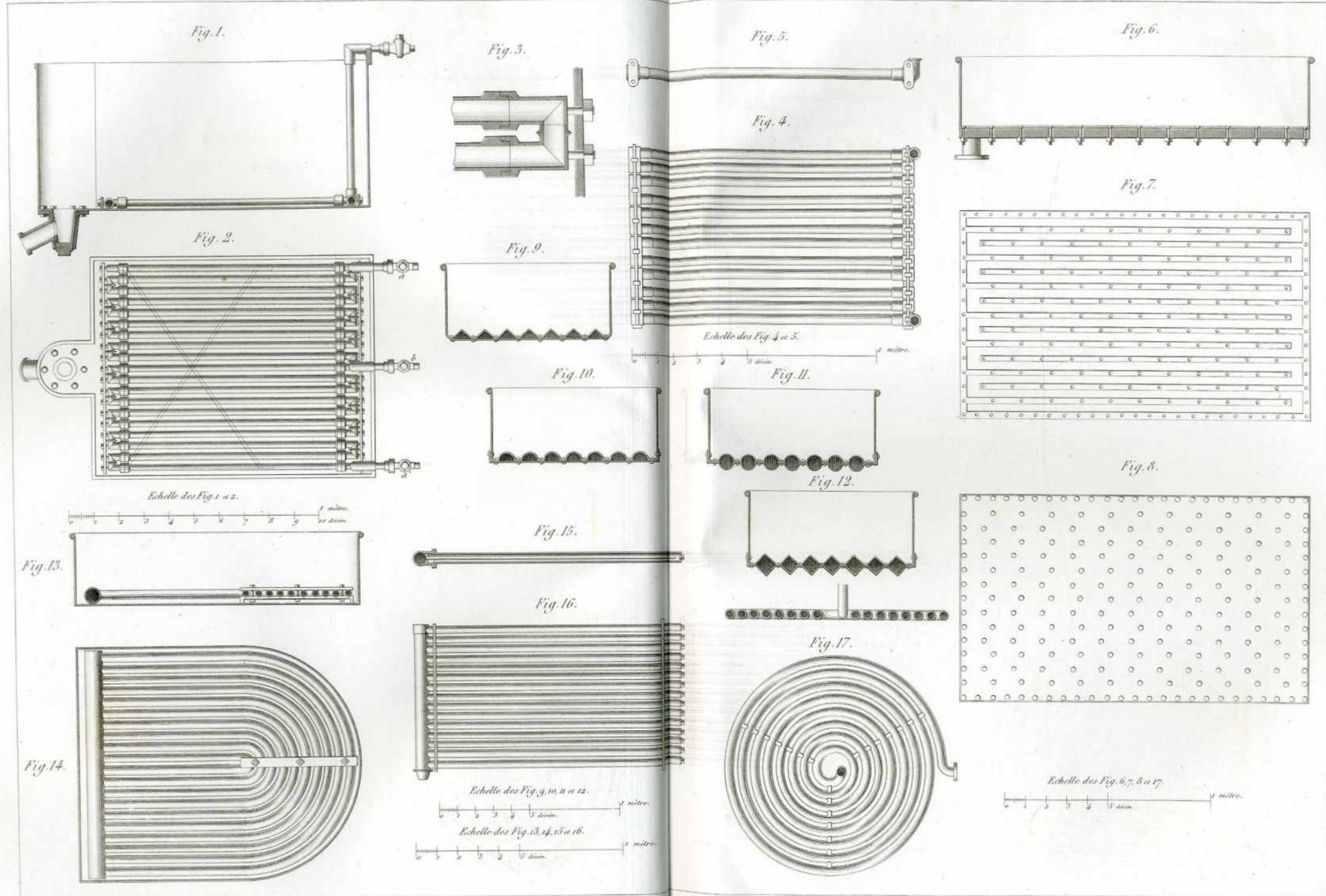
Echelle des Fig. 7, 8, 9, 10 et 11.
0 1 2 3 4 5 6 7 8 9 10
10 décim.
2 mètres.

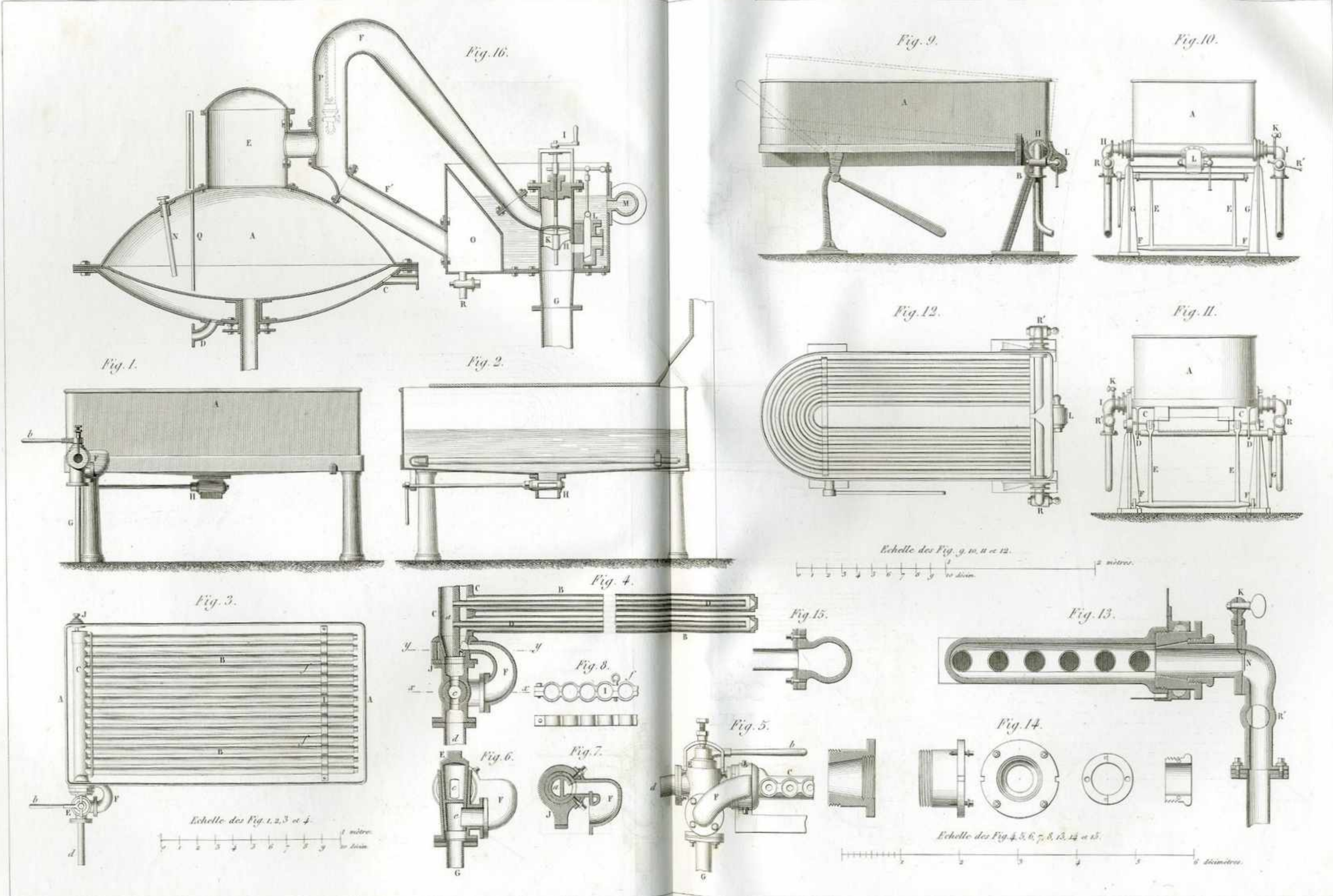


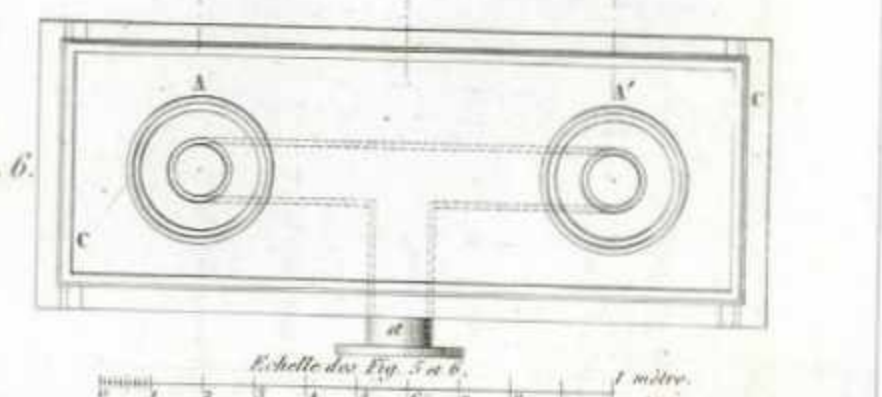
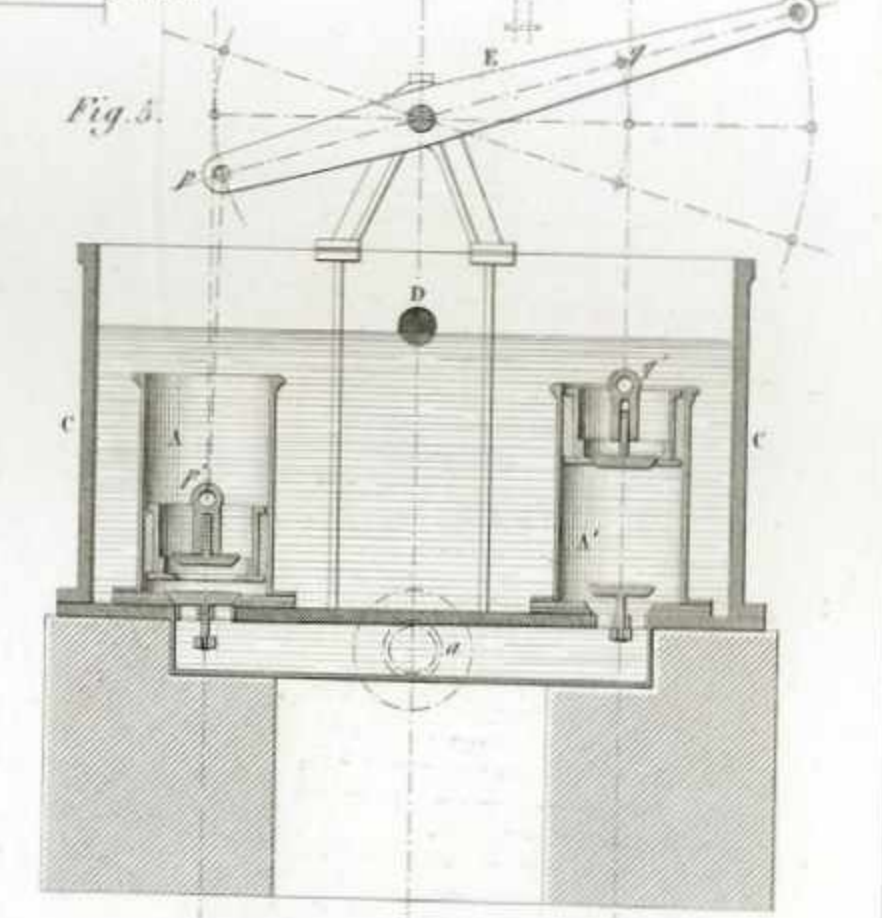
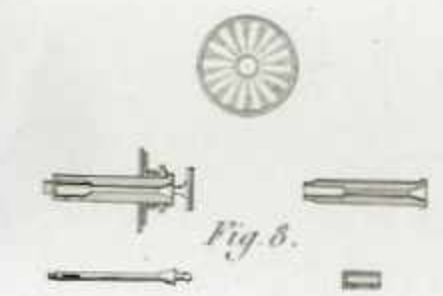
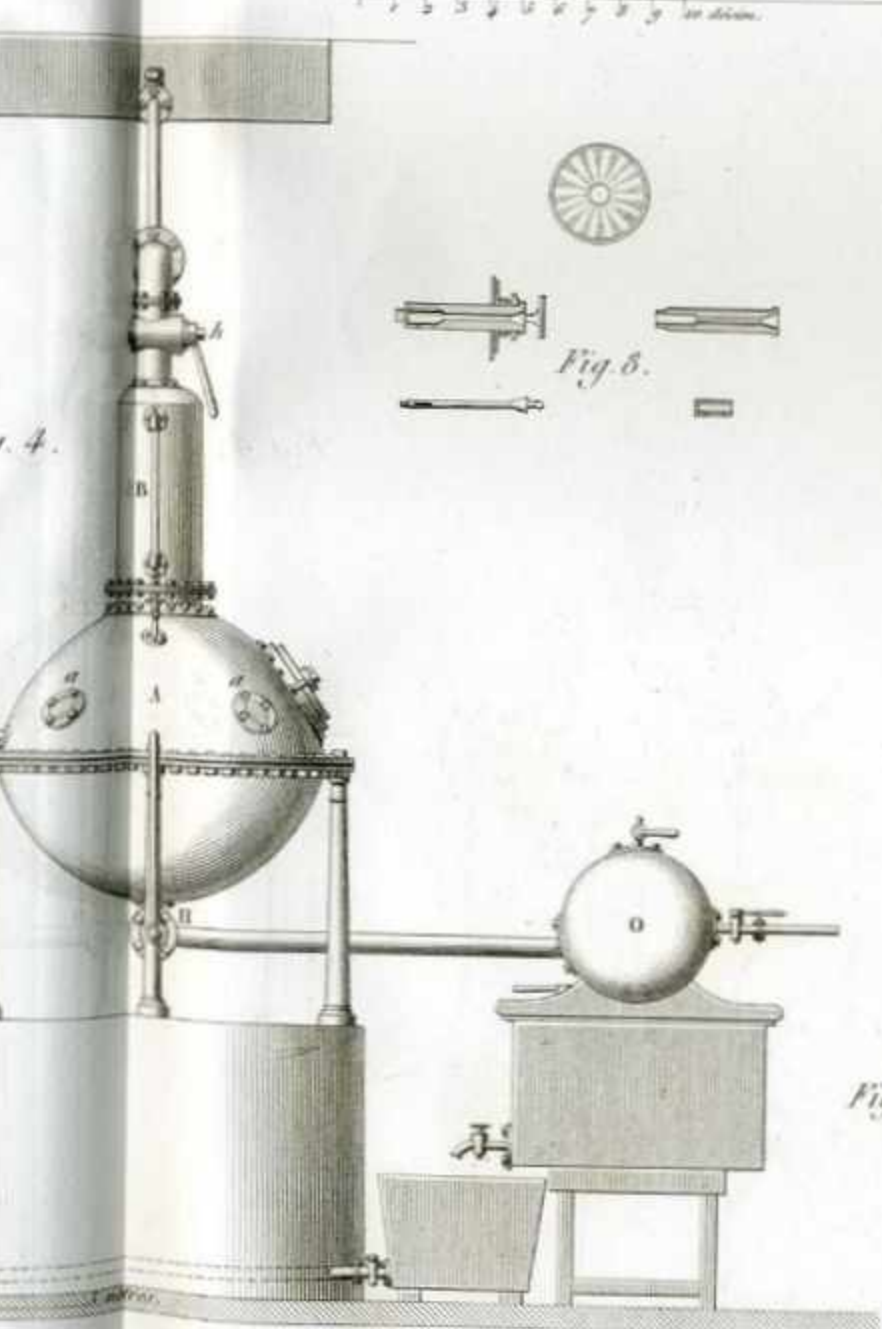
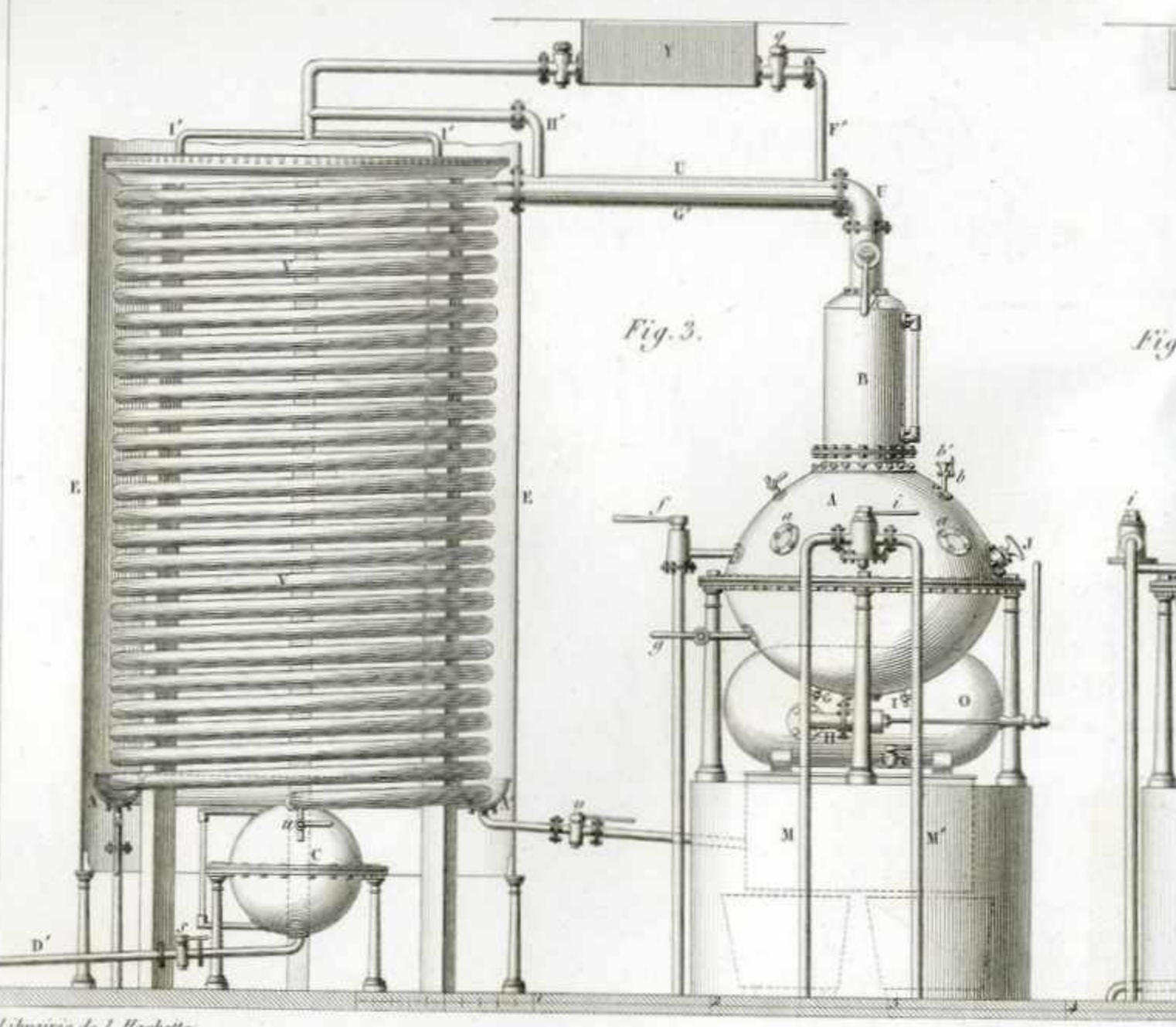
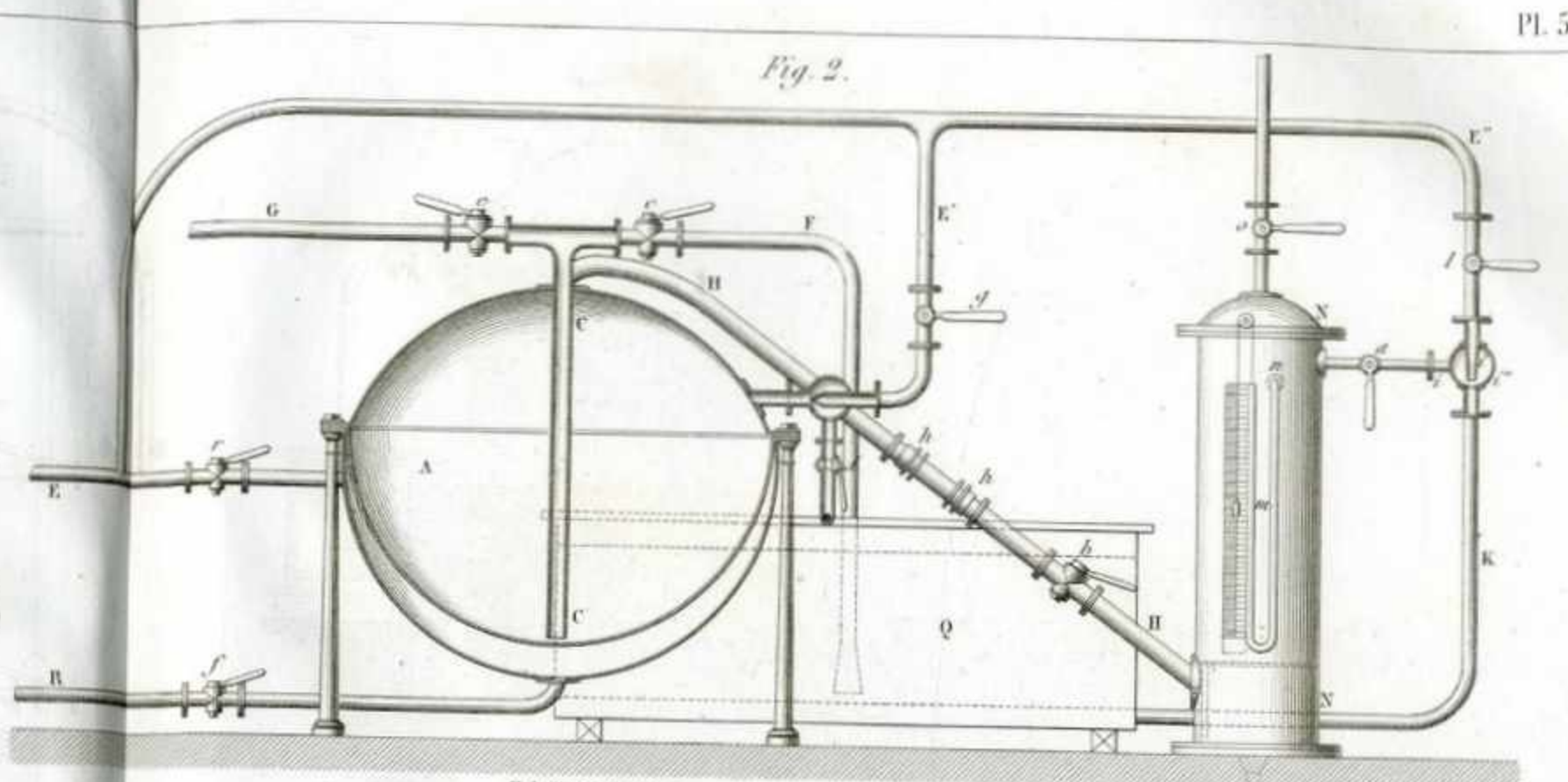
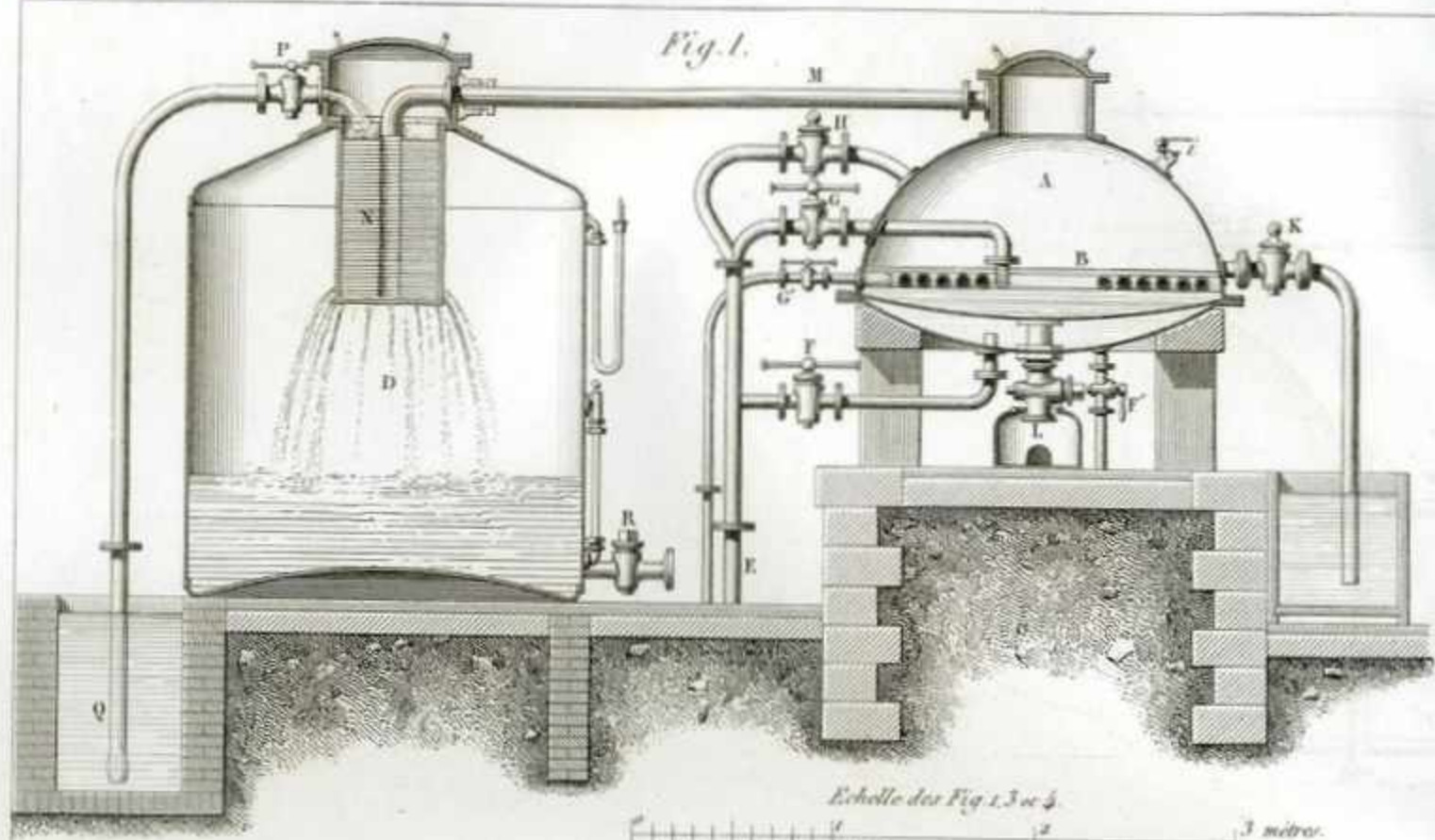


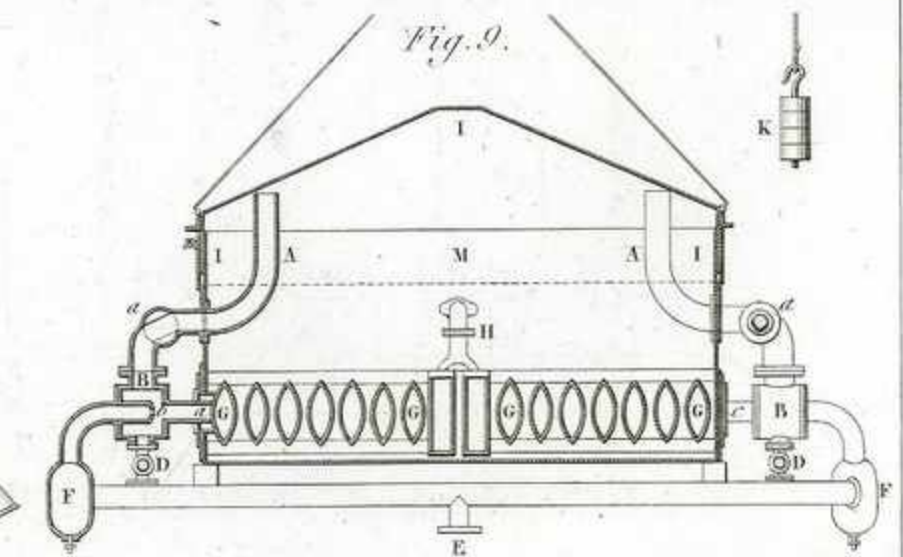
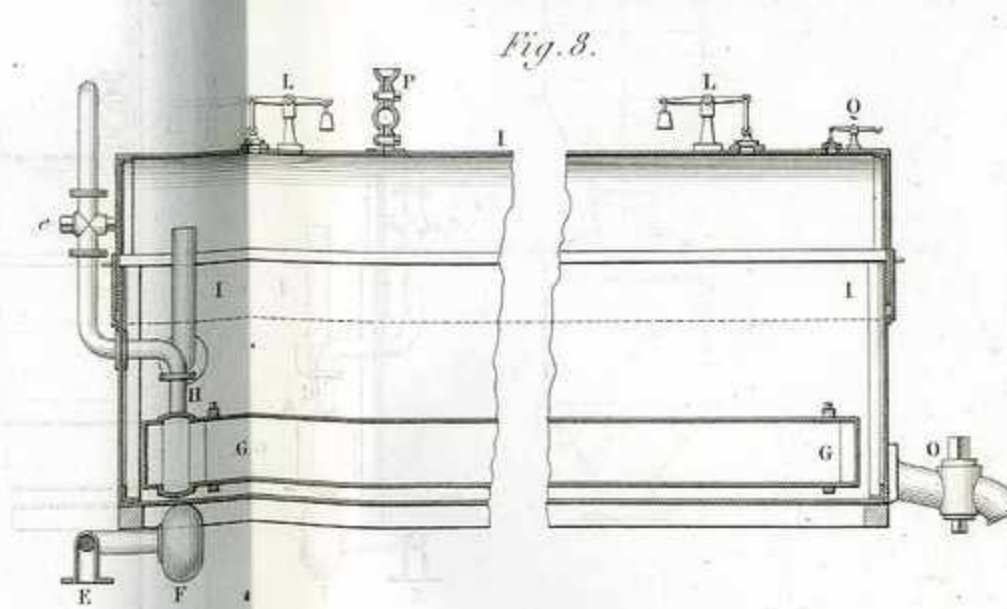
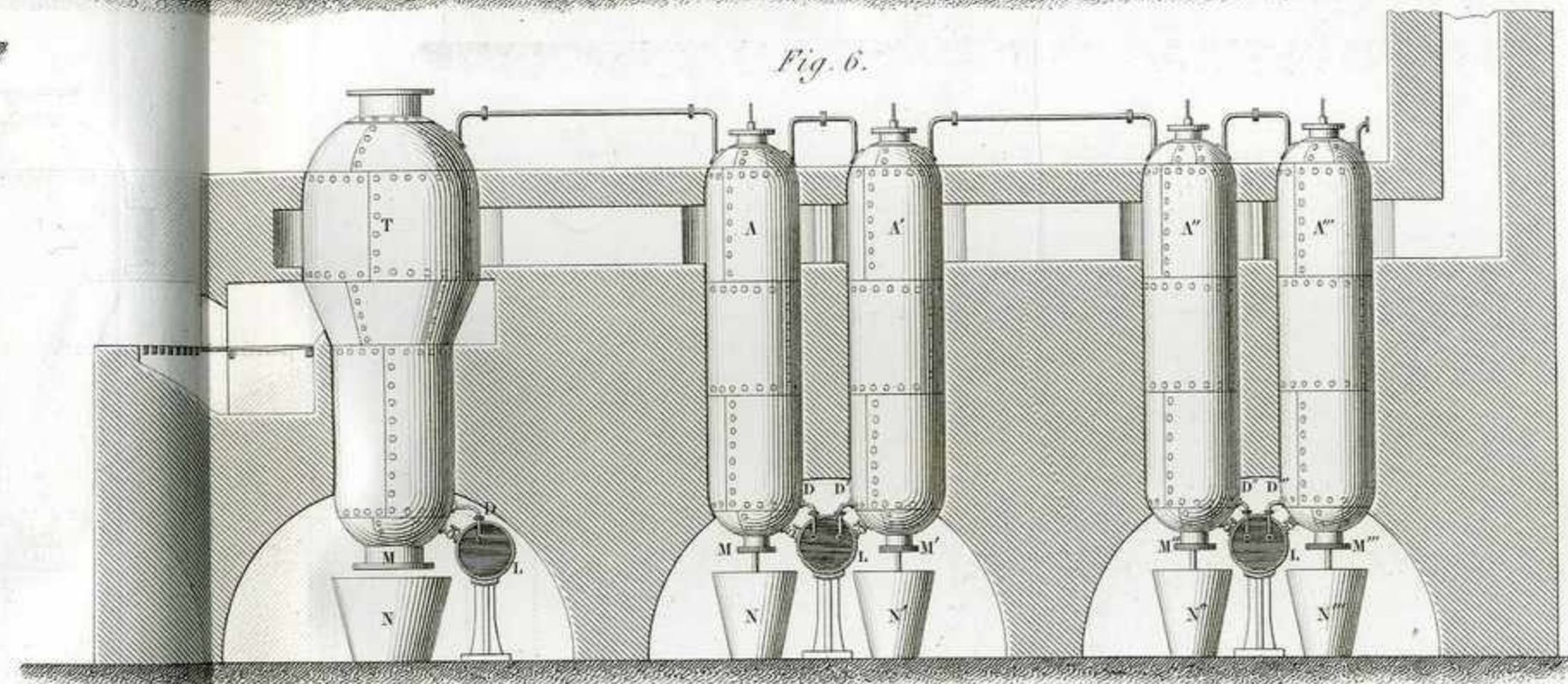
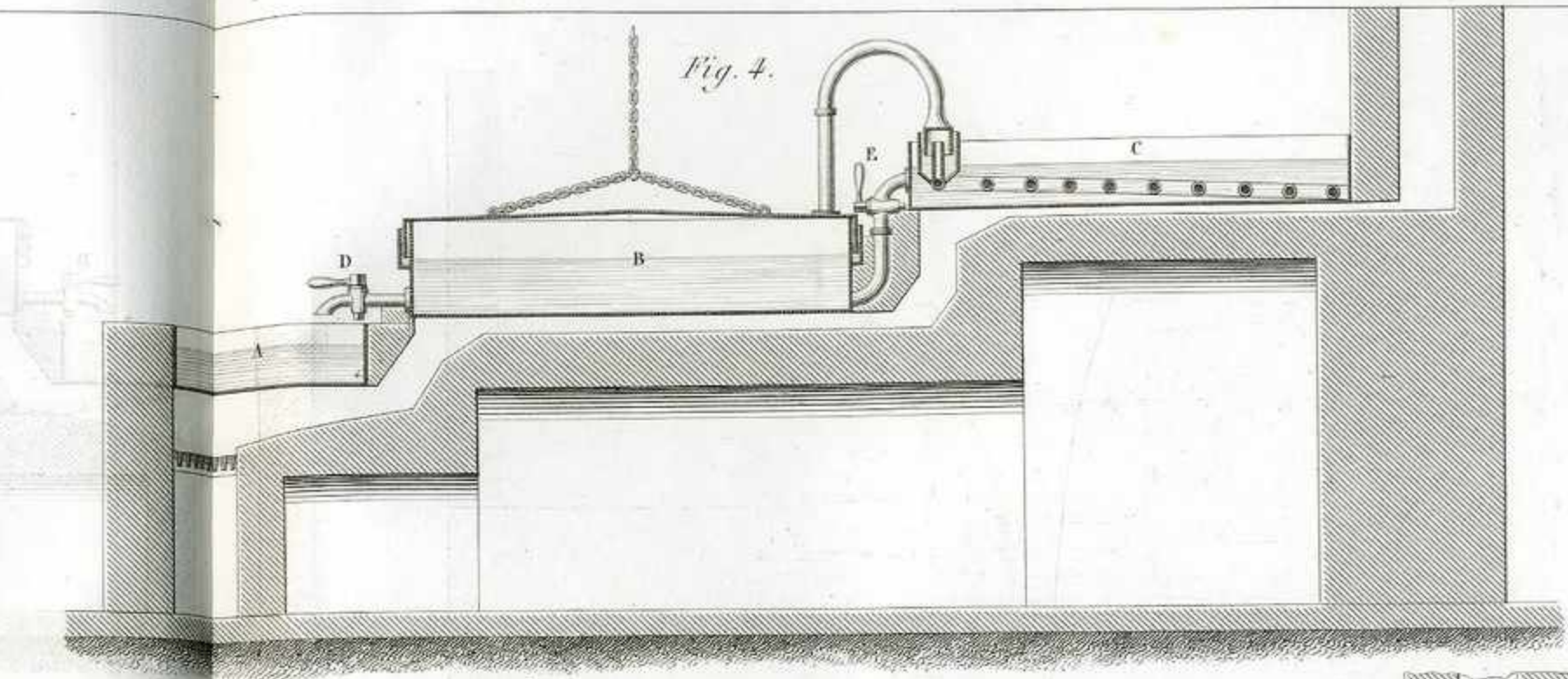
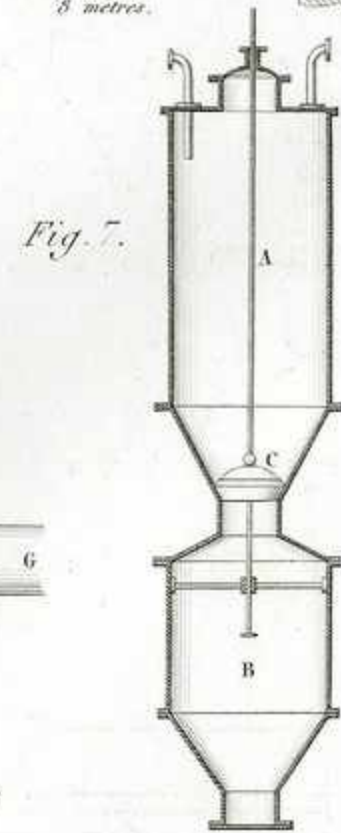
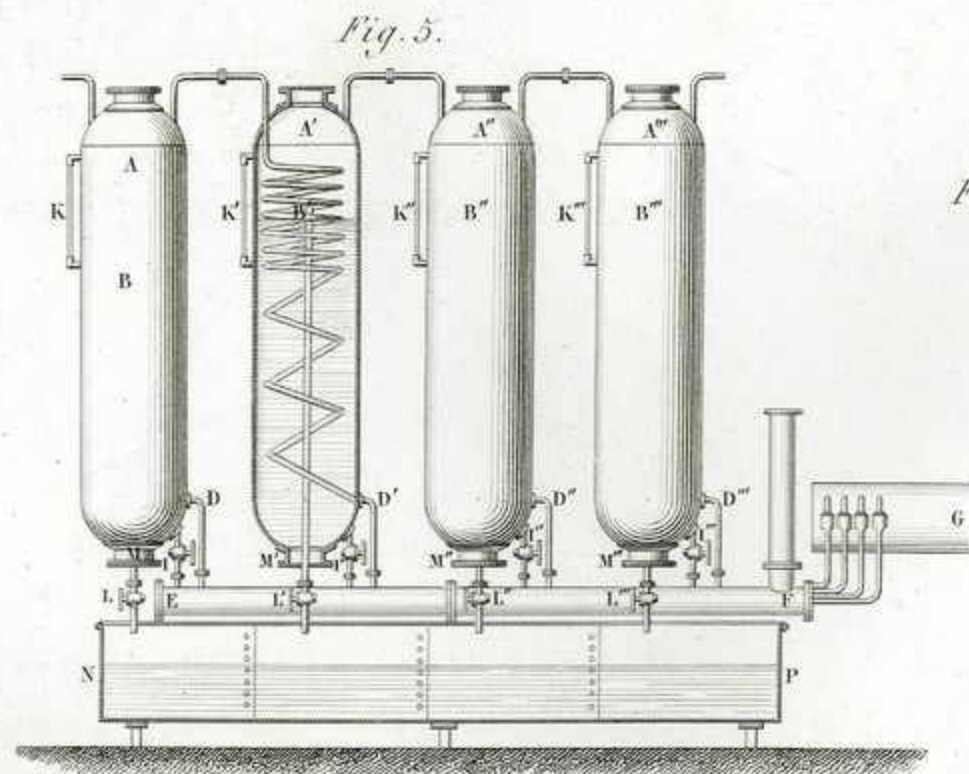
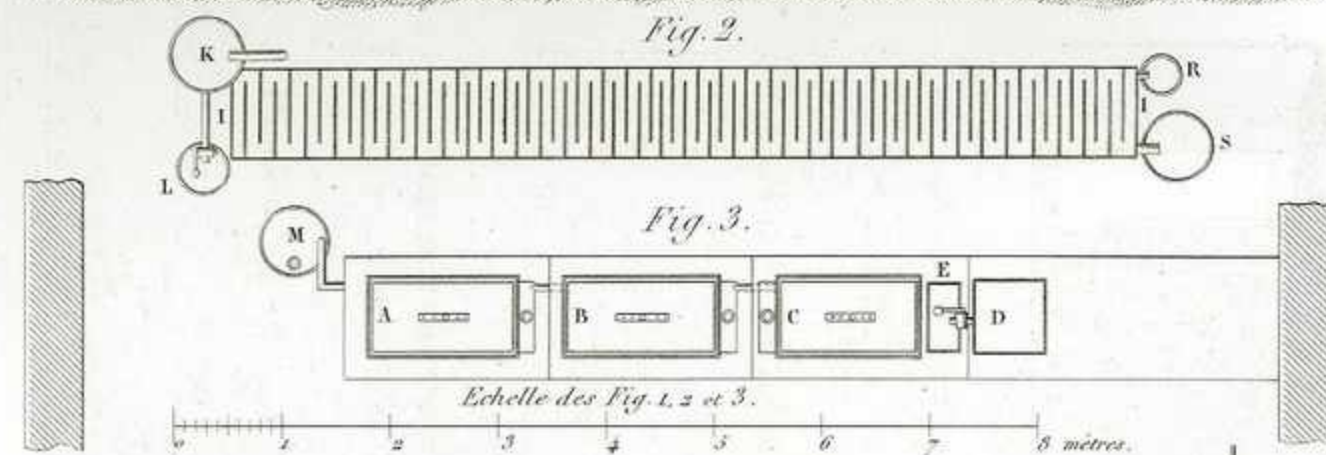
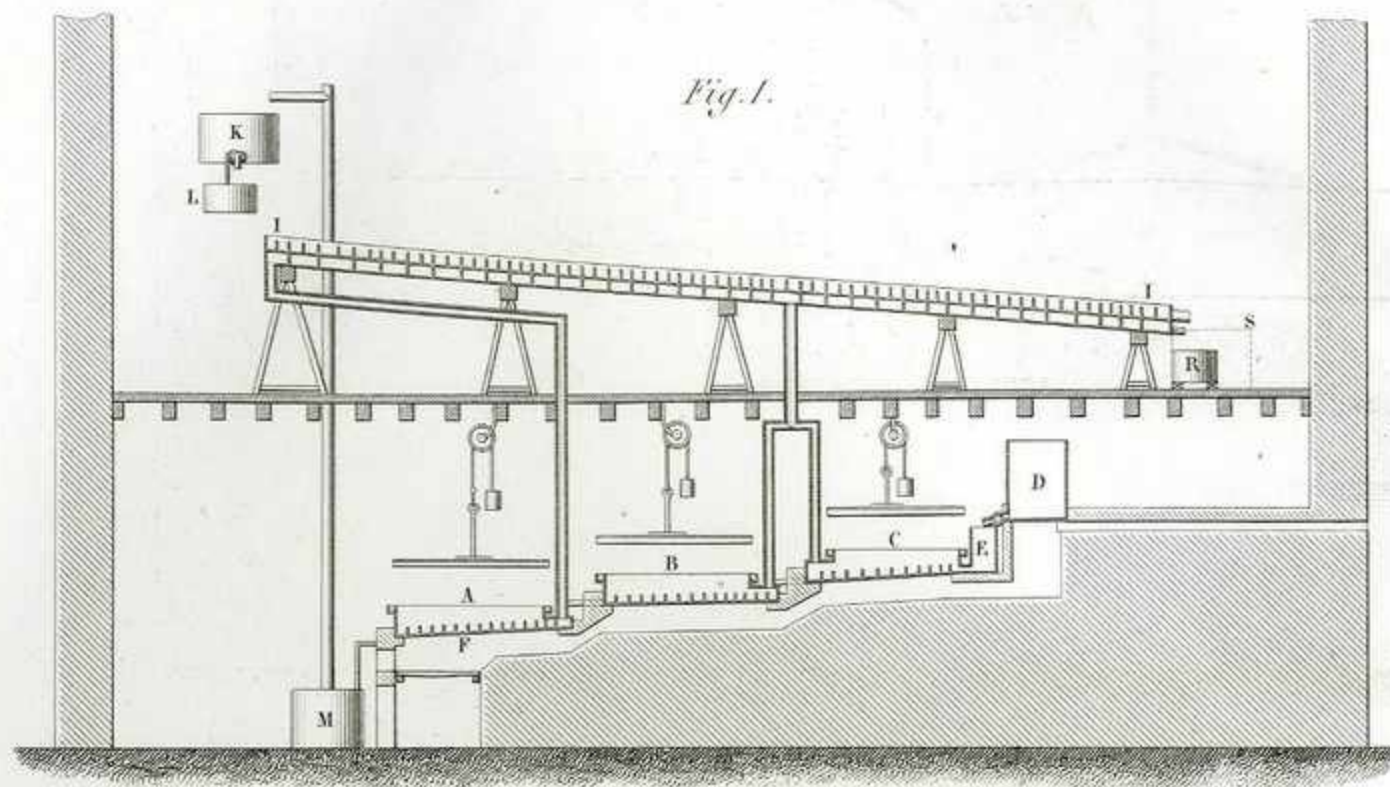


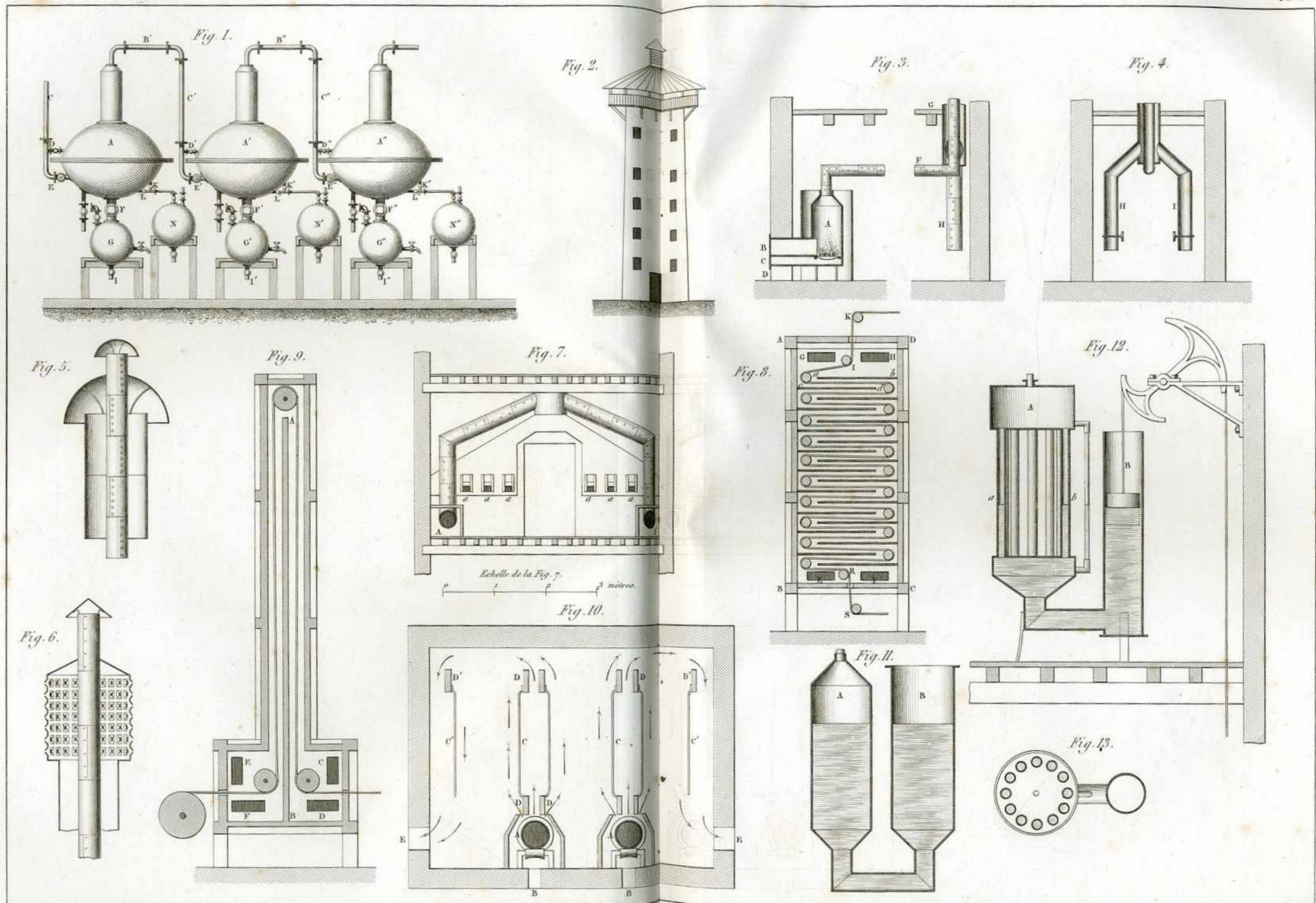
Echelle des Fig. 10, 11, et 12. 1 mètre.

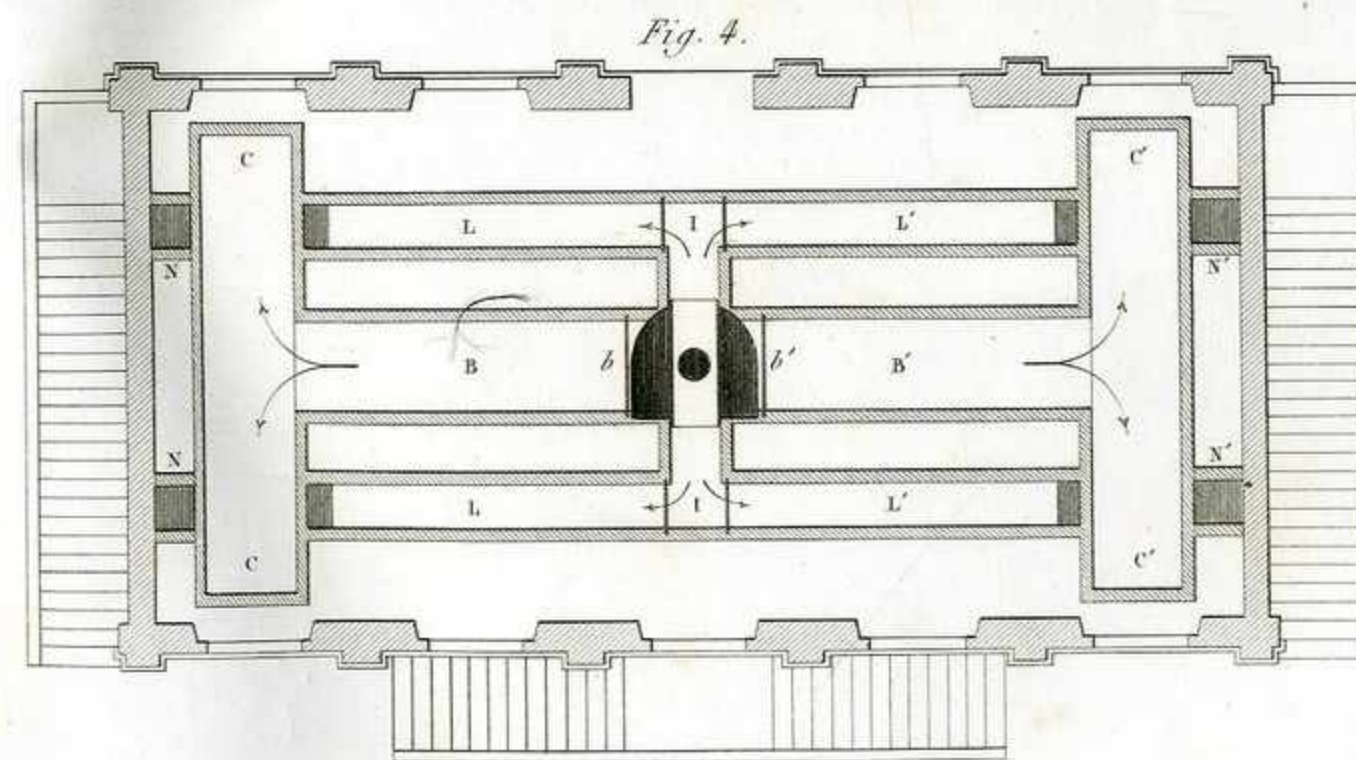
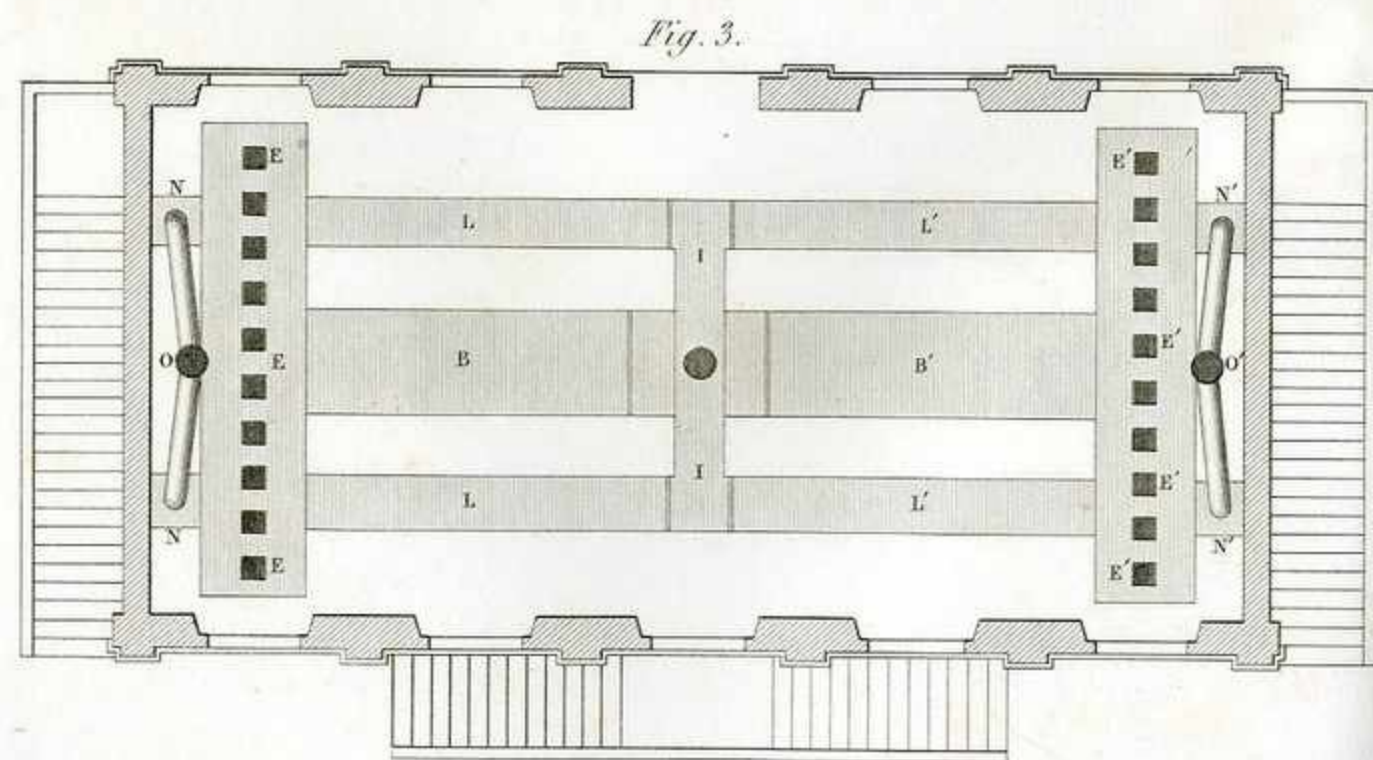
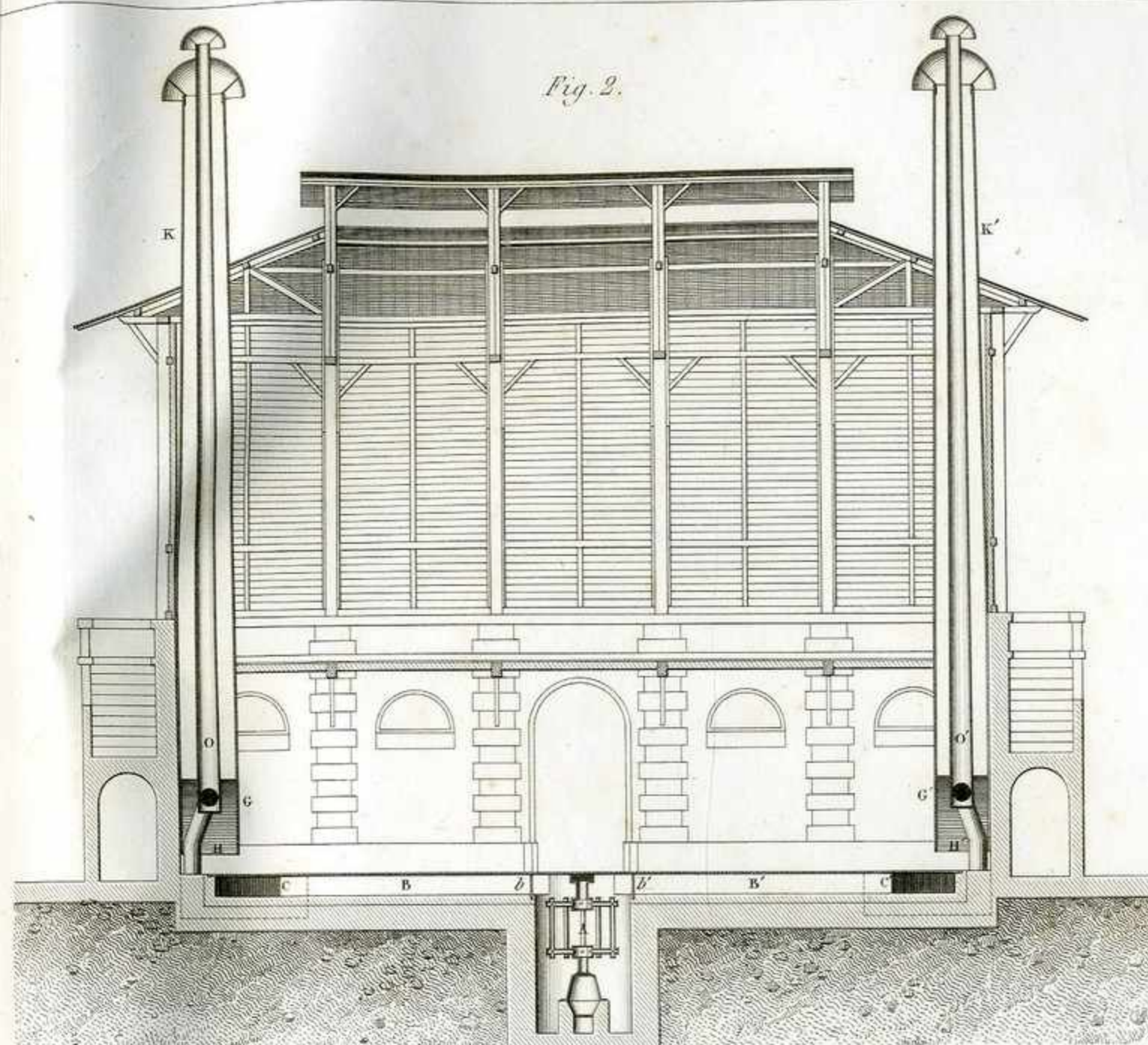
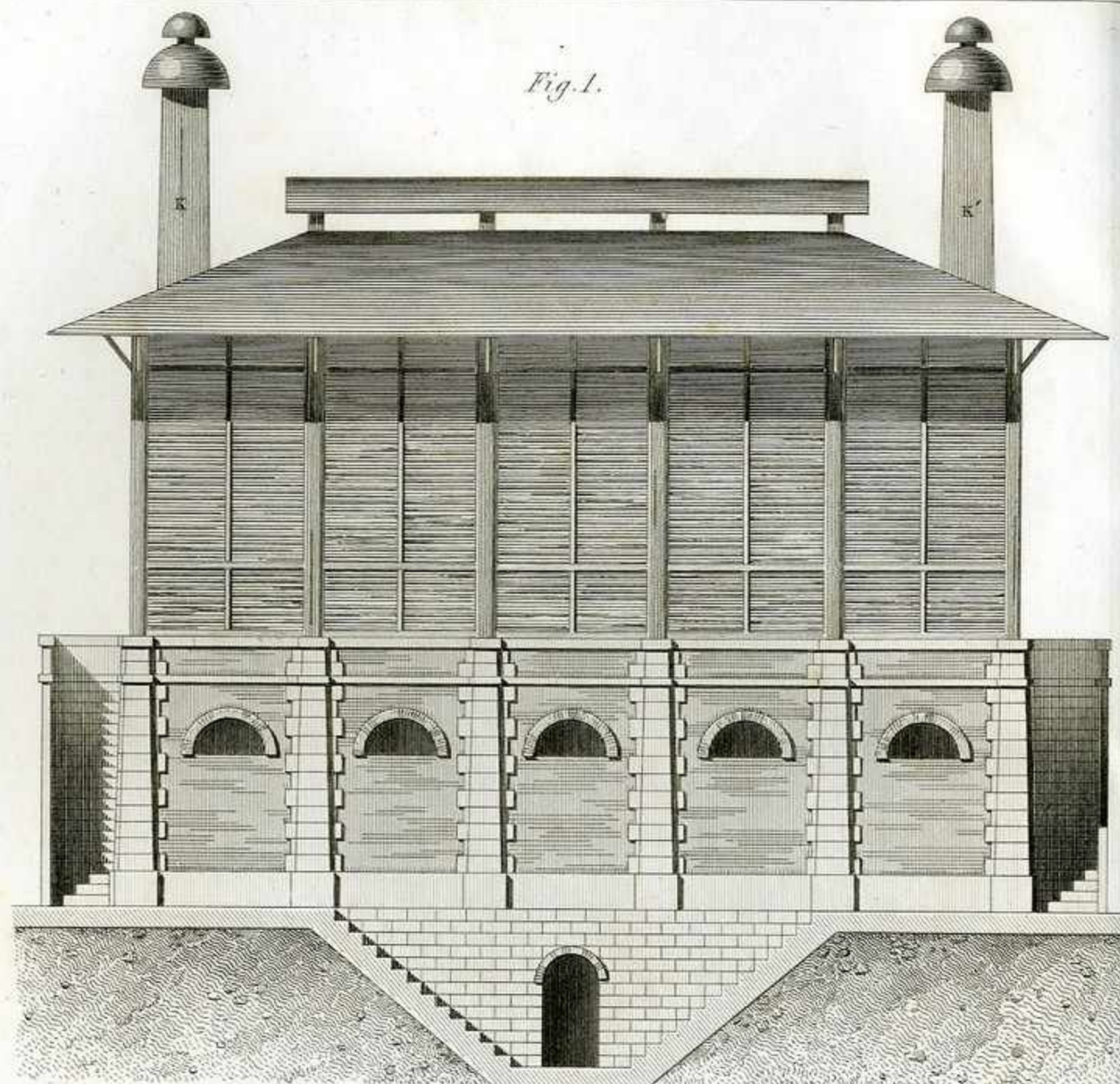




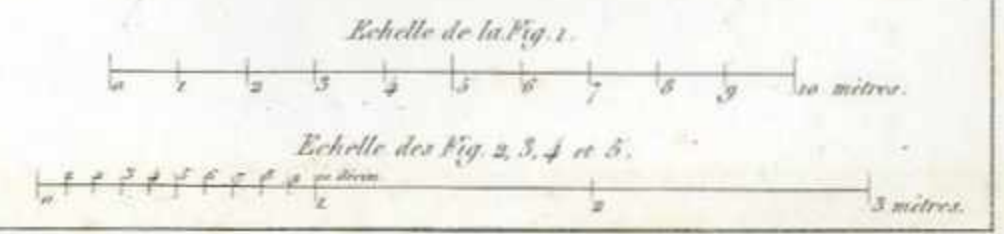
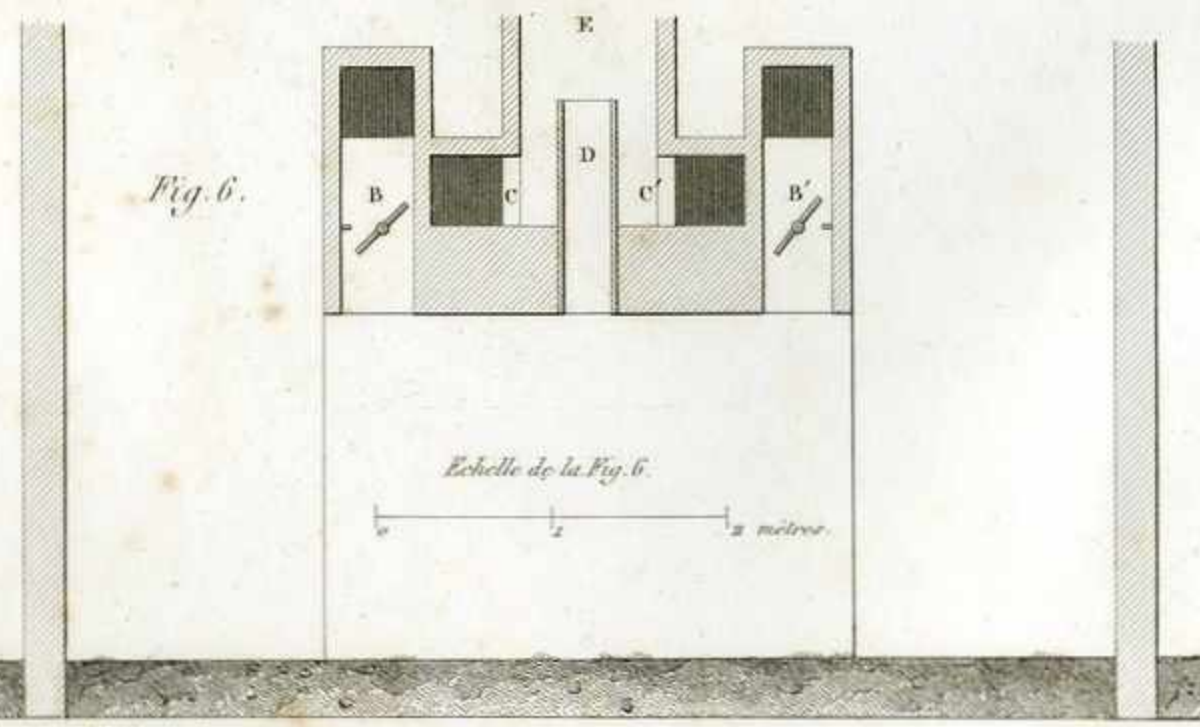
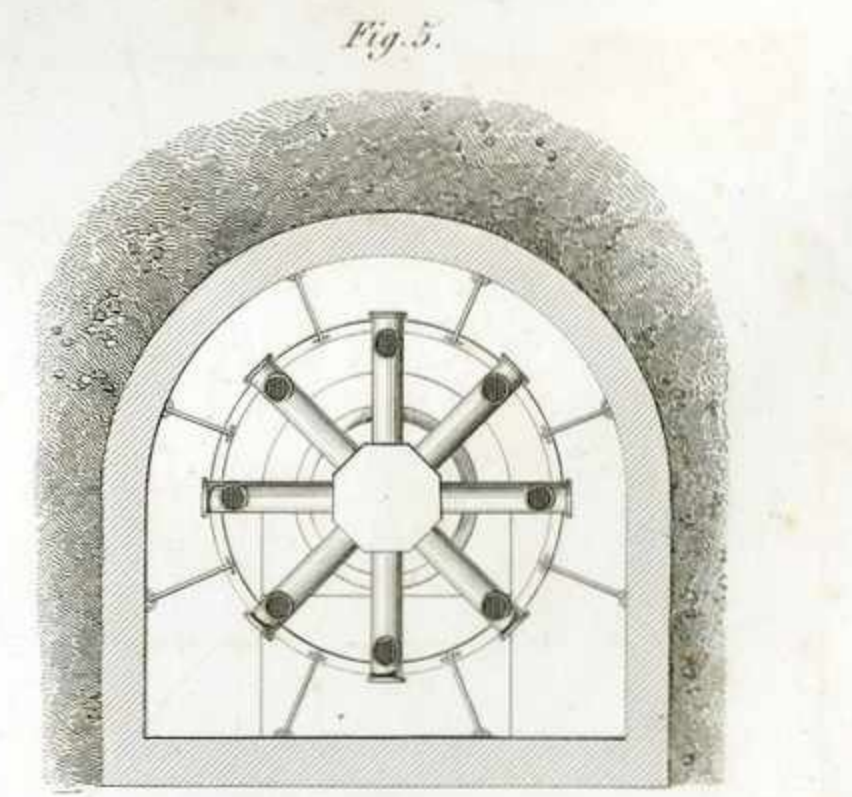
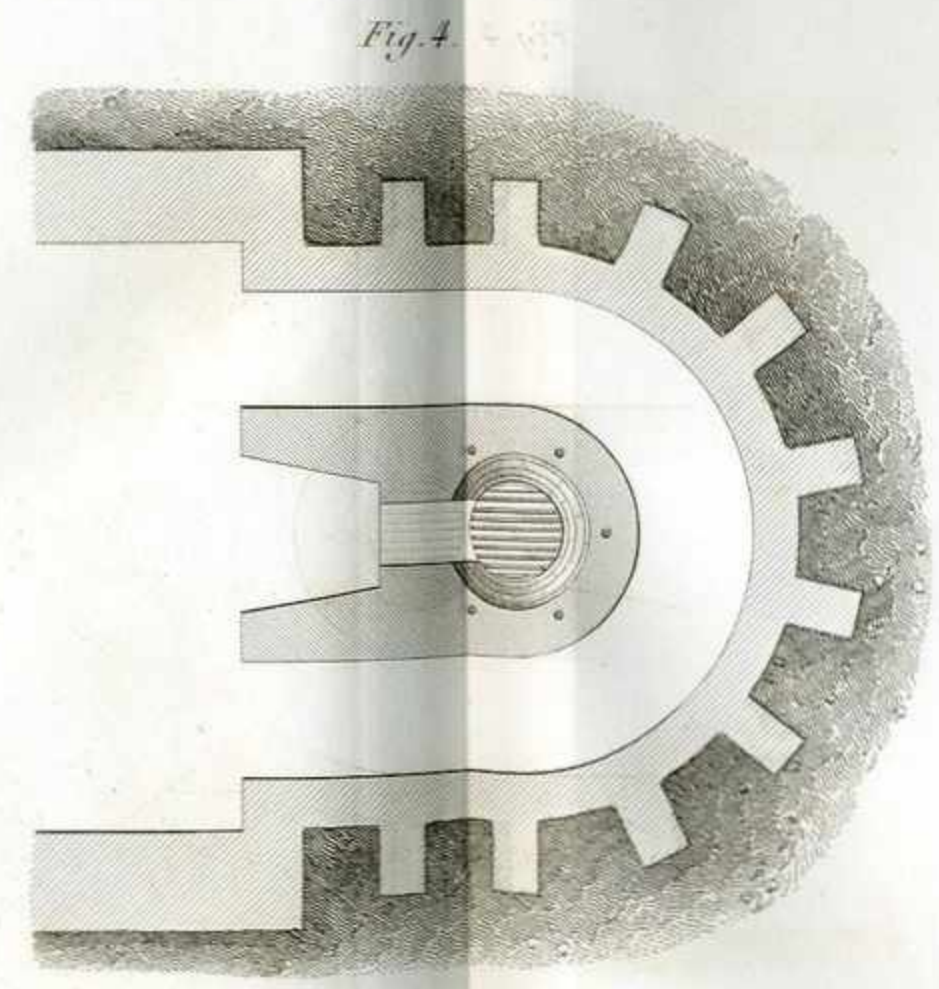
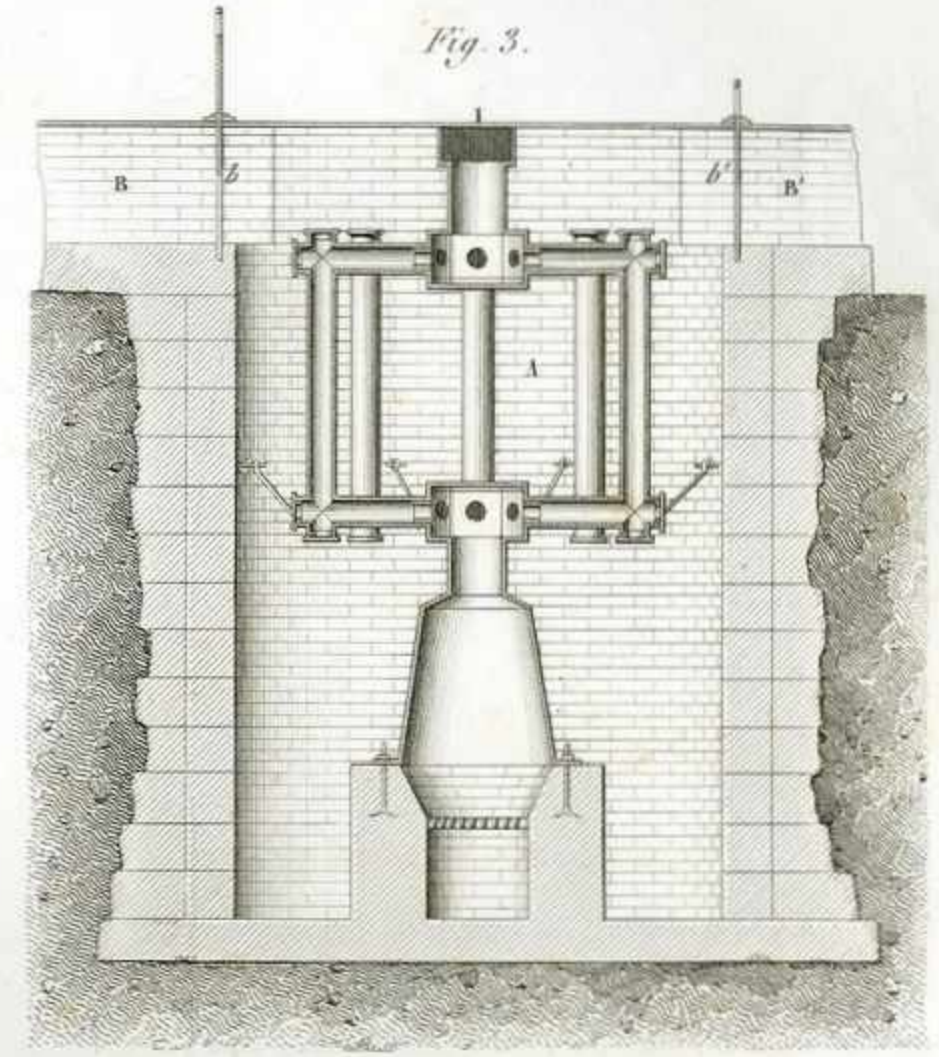
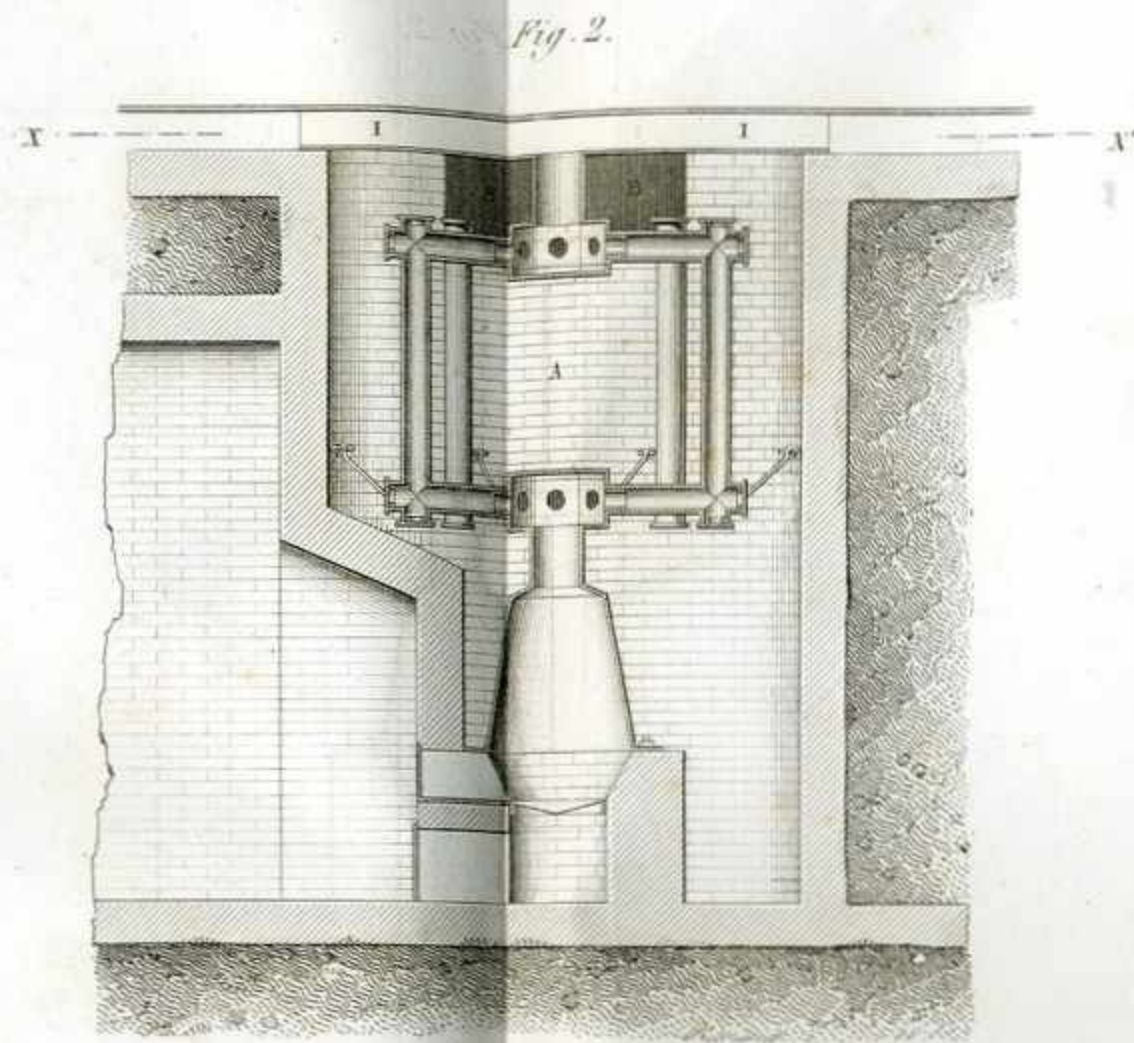
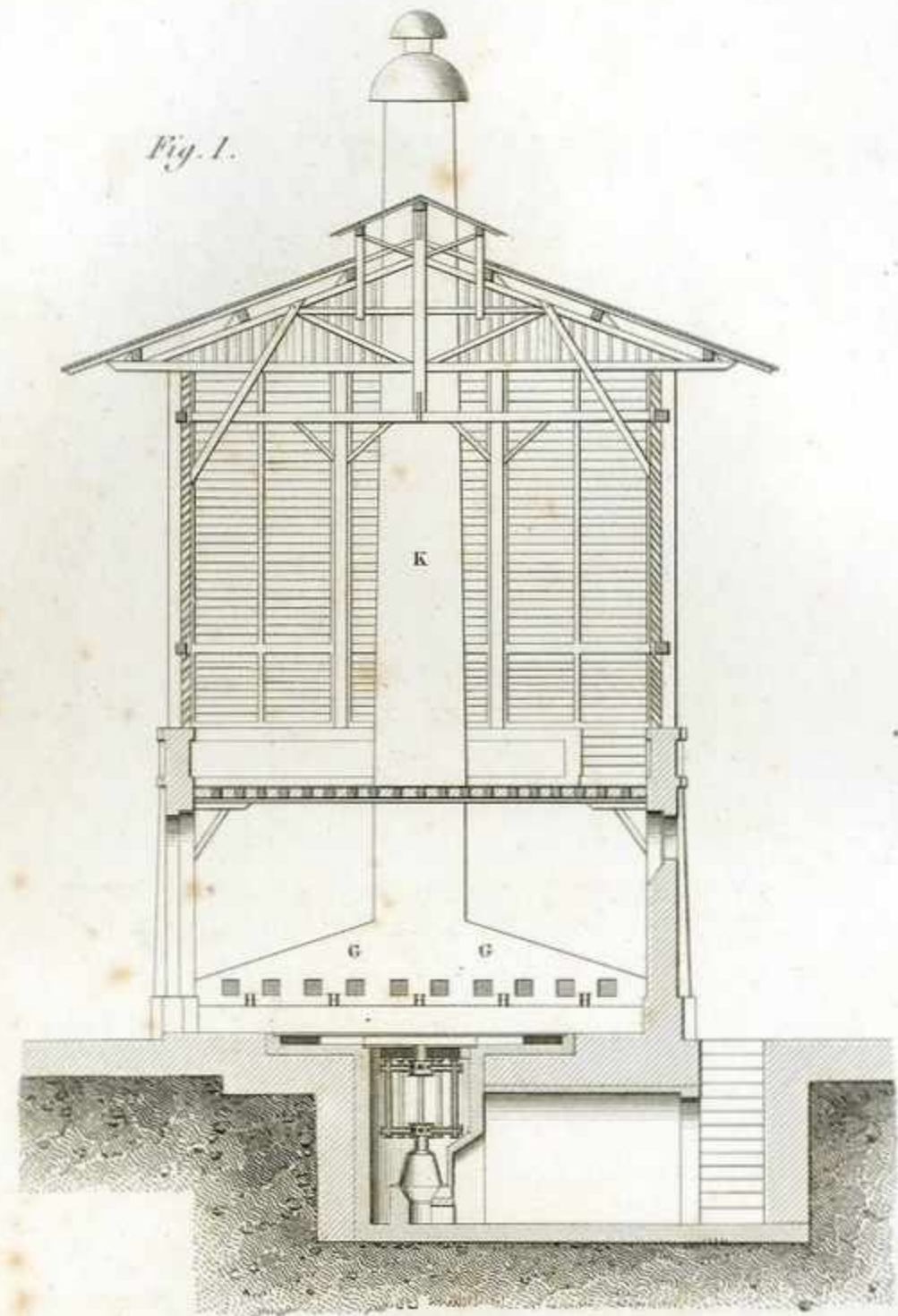


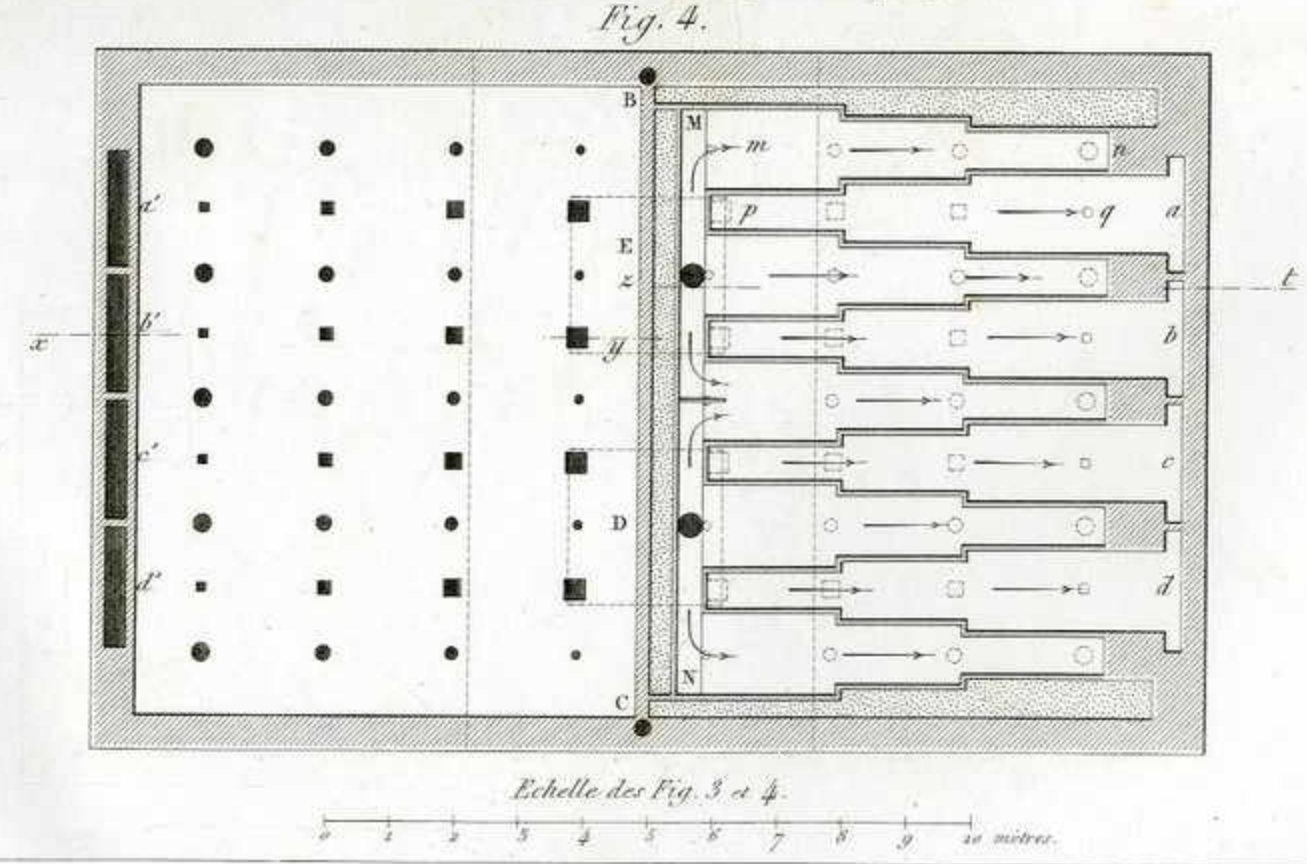
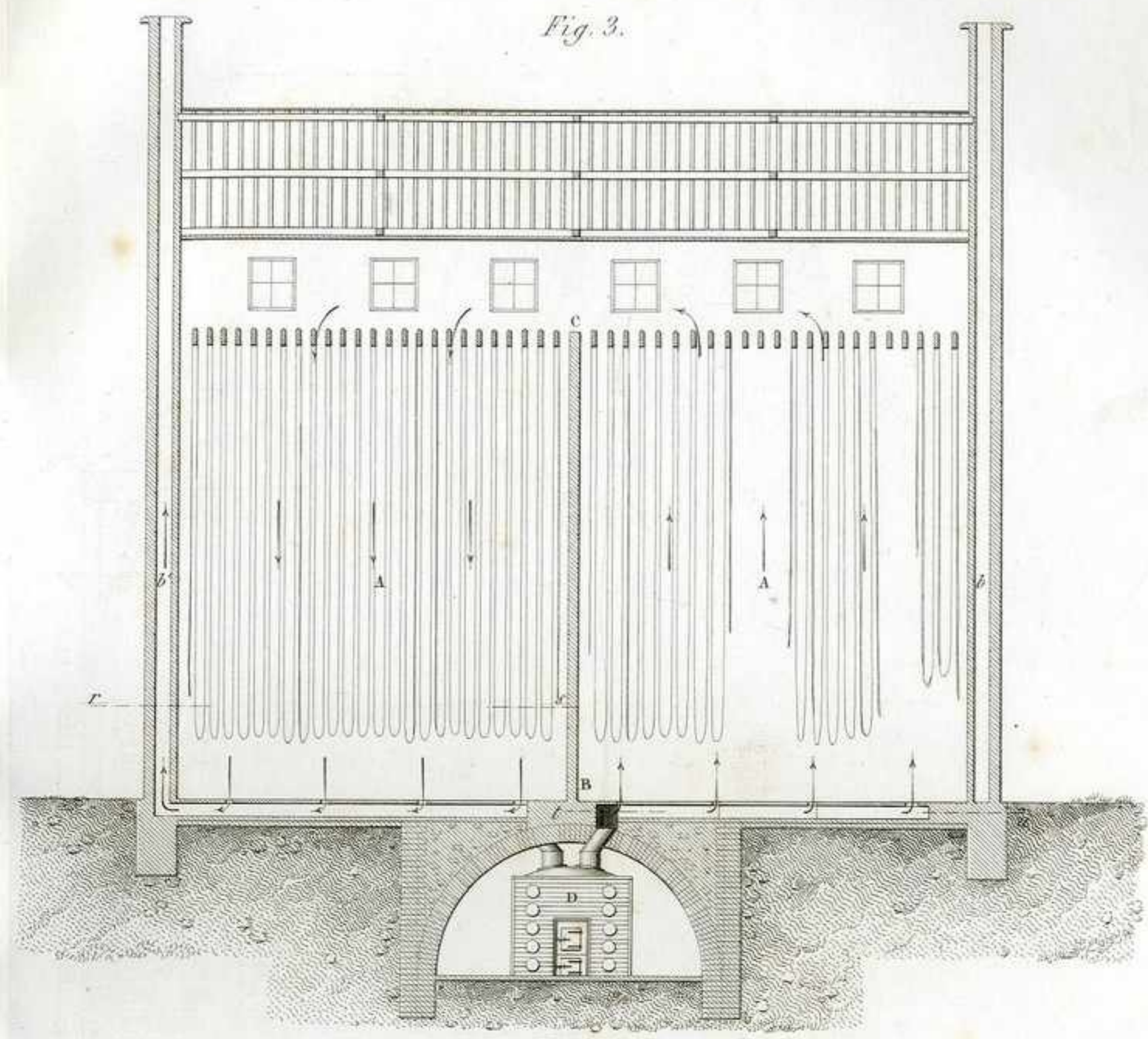
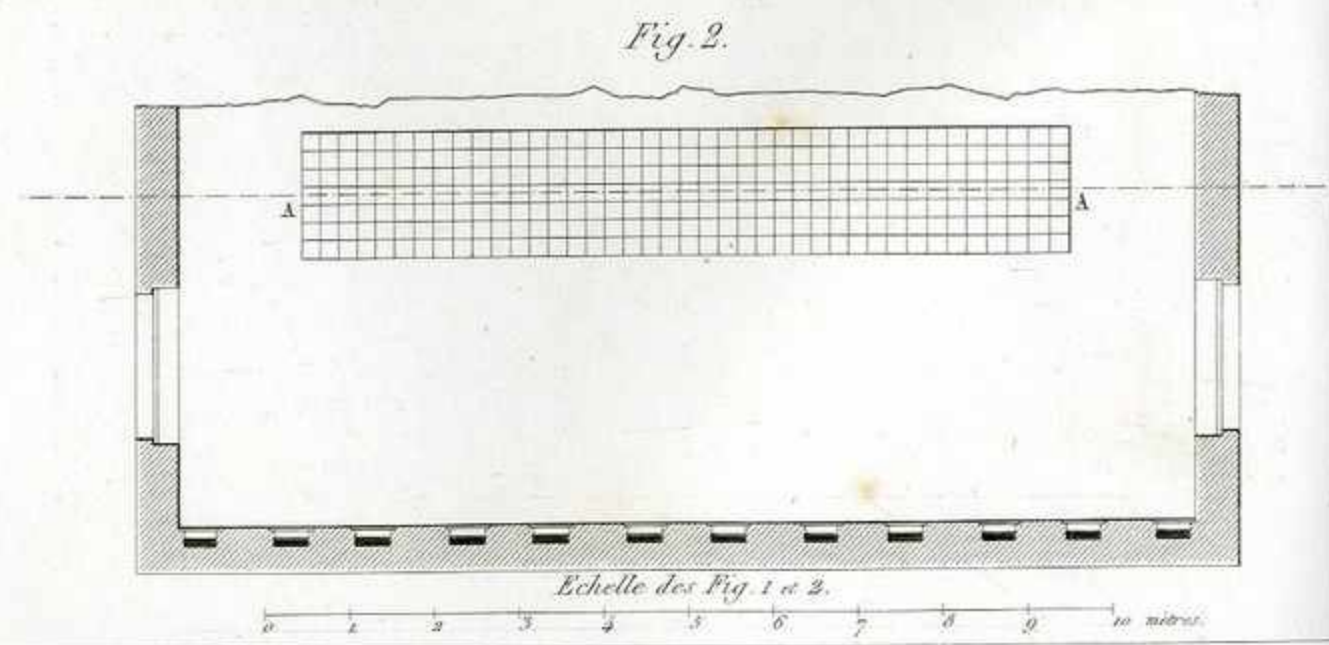
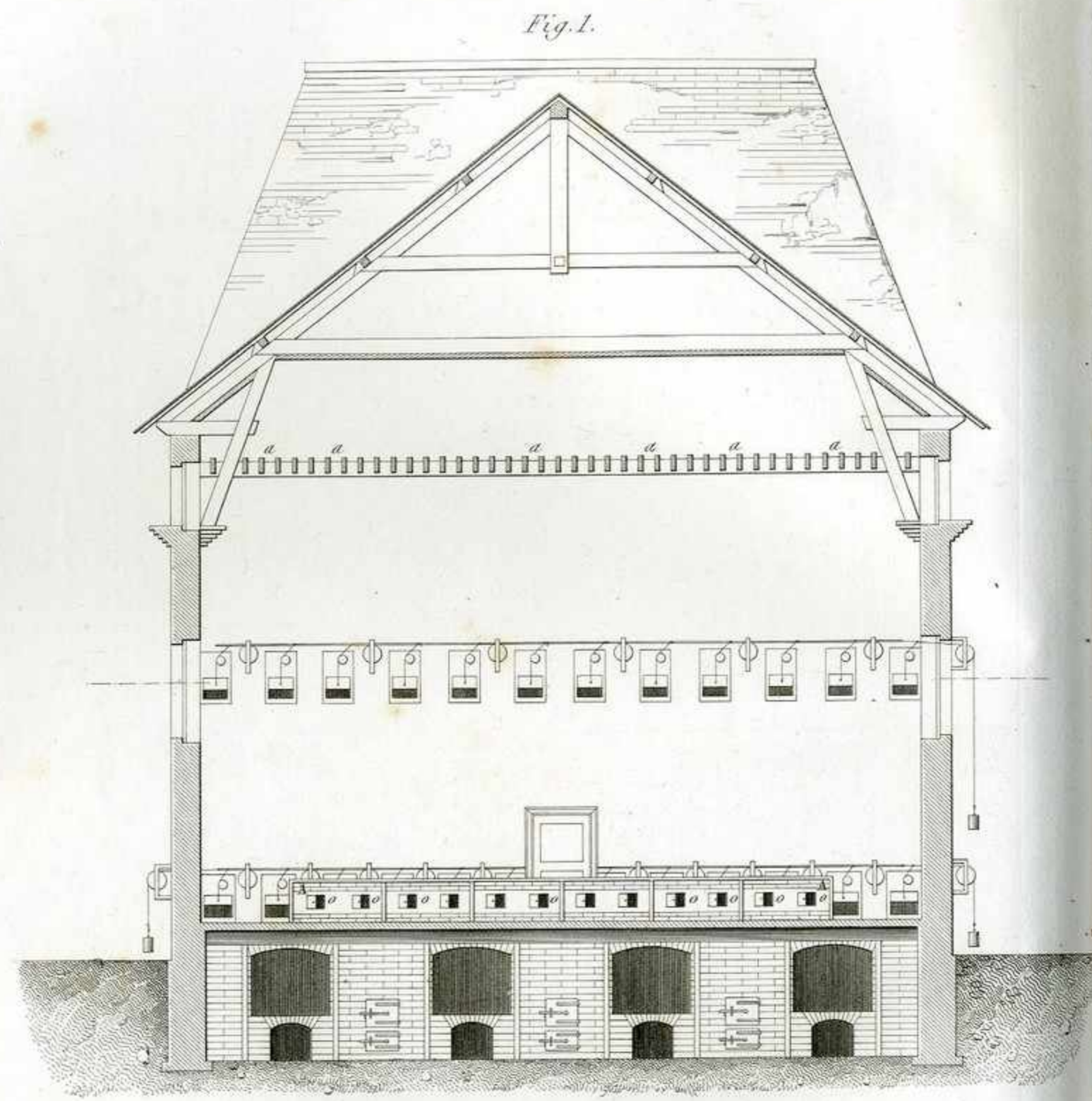


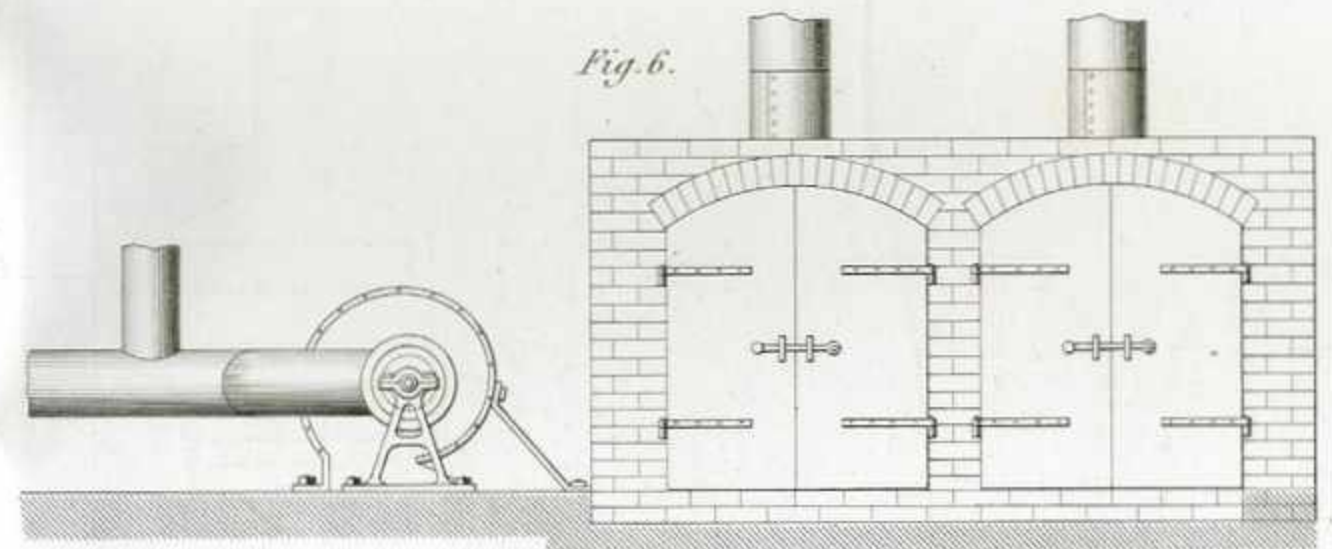
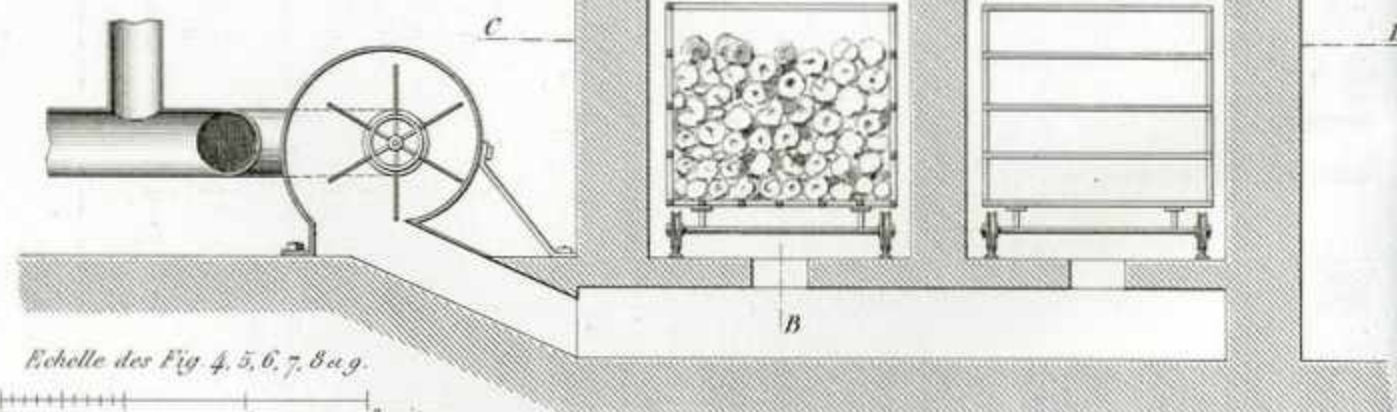
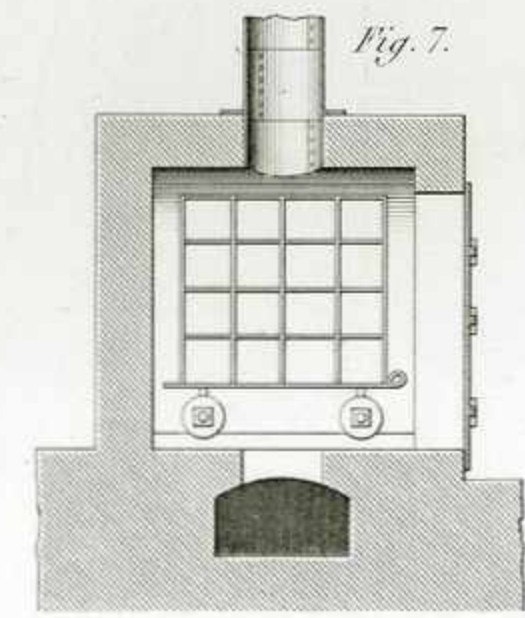
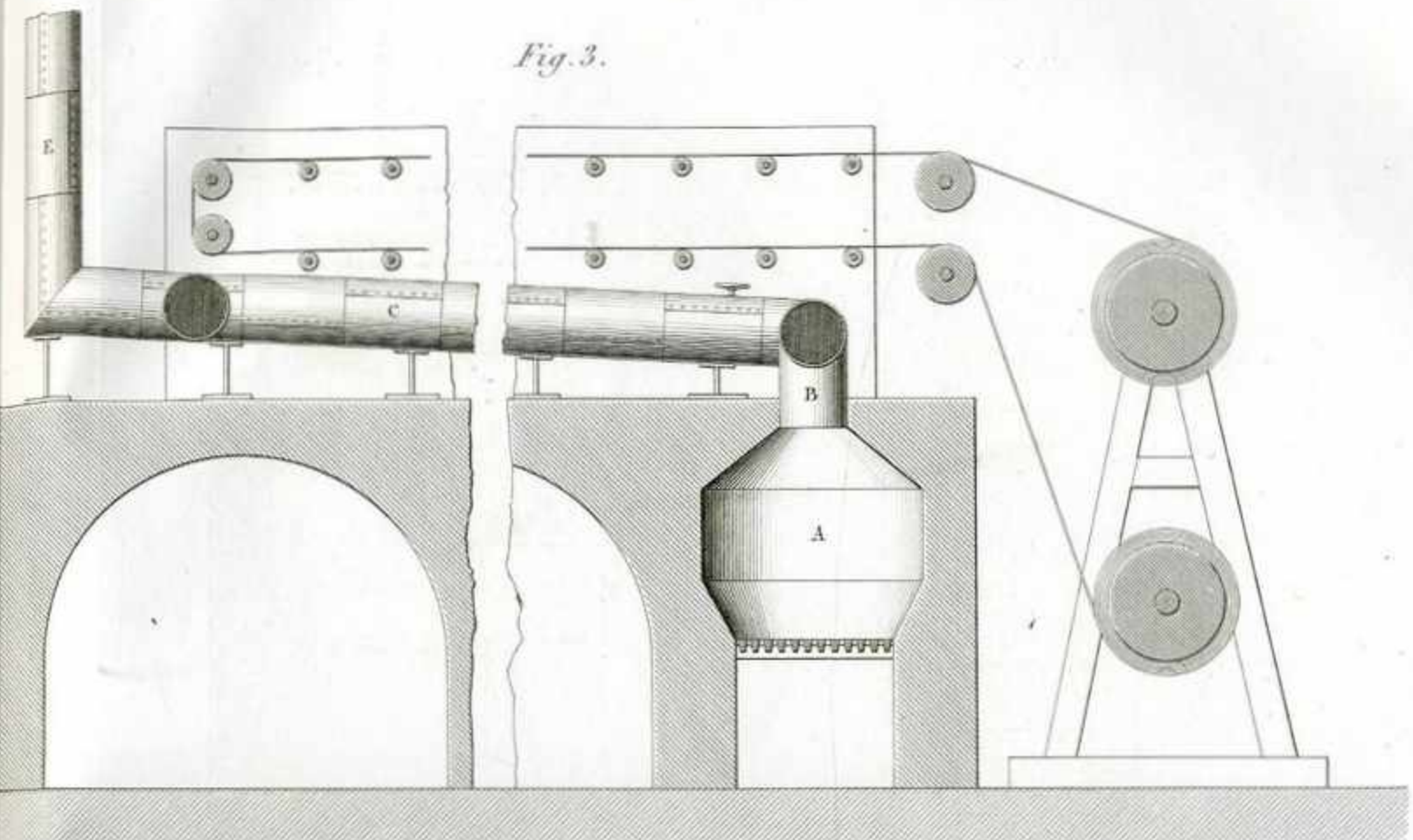
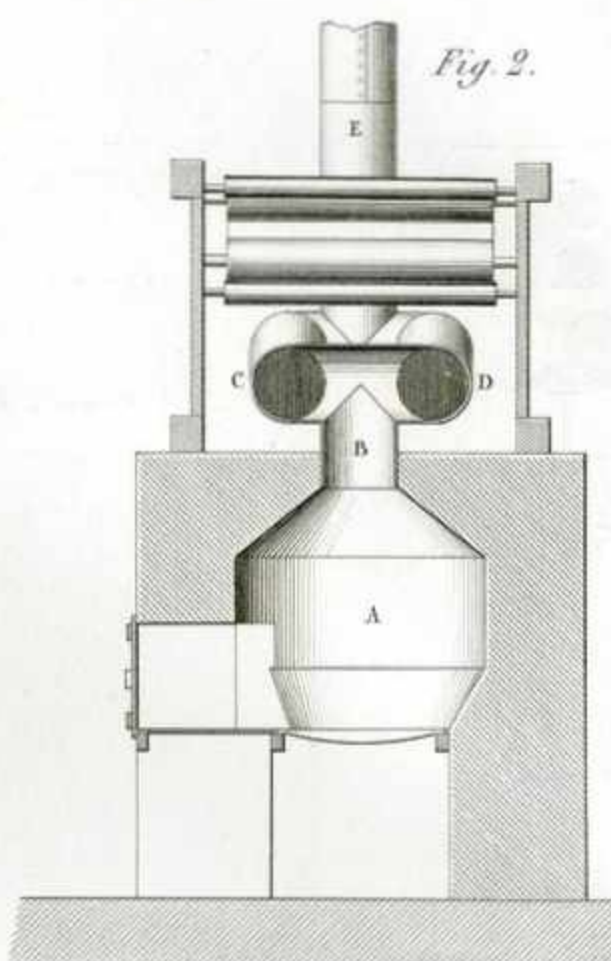
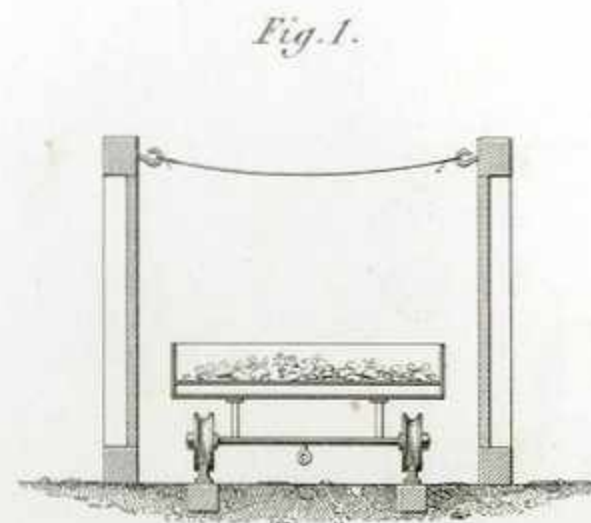




Echelle.
0 1 2 3 4 5 6 7 8 9 10 11 12 13 14 15 mètres.







Echelle des Fig. 4, 5, 6, 7, 8 et 9.
0 1 2 3 metres.

